

# NCDS 4P50-200

1750 n [min<sup>-1</sup>]

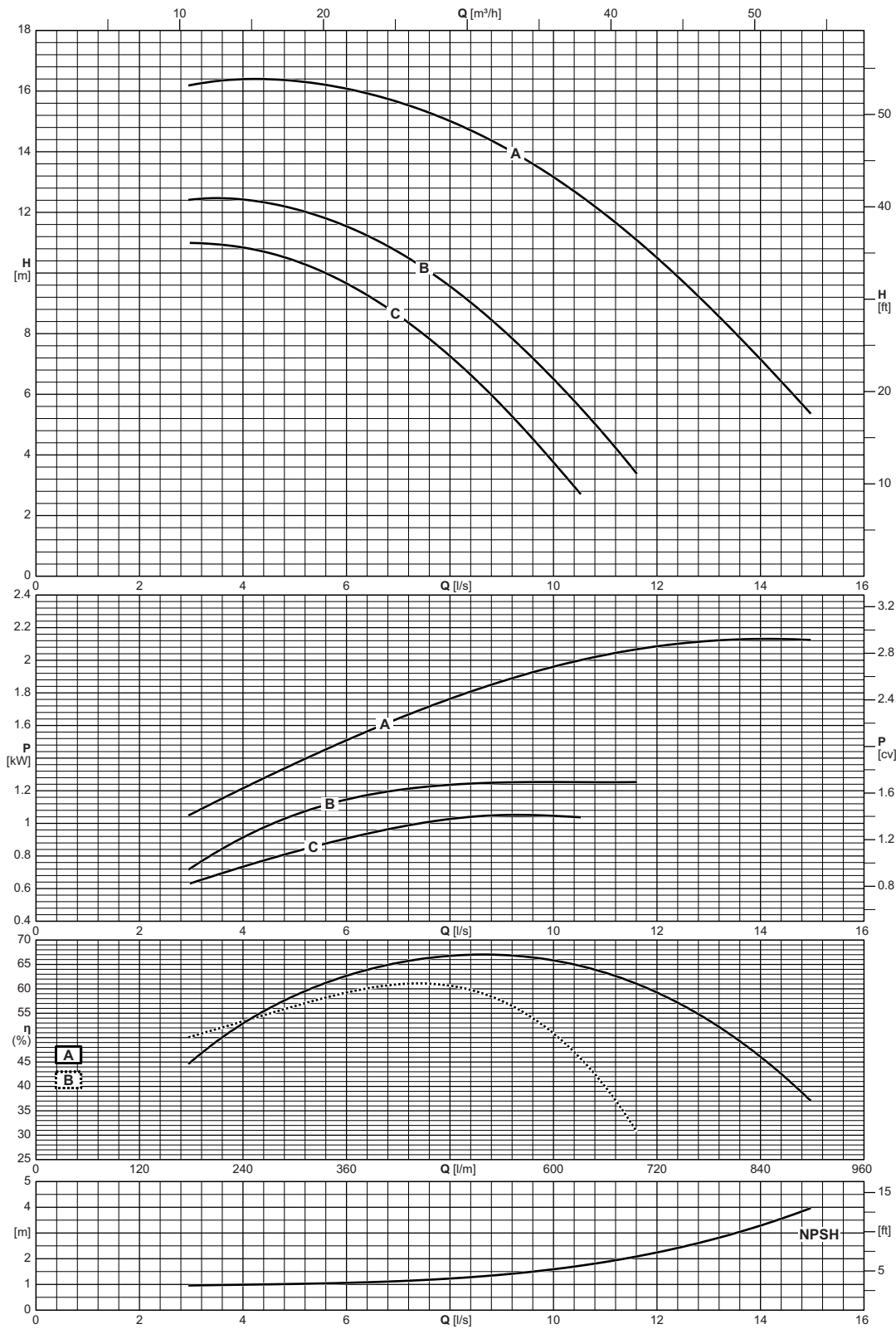

Operating data  
 Caracteristiques de fonctionnement  
 Caratteristiche di funzionamento



Type Type Tipo	Inlet maximum pressure Pression maximale en aspiration Pressione massima in aspirazione
NCDS4P50-200	[bar] 10

Overall dimensions and weights  
 Dimensions d'encombrement et poids  
 Dimensioni di ingombro e pesi



Type Type Tipo	Weight Poids Peso [kg]	Dimensions pump Dimensions pompe Dimensioni pompa										Duck foot pedestal dimensions Dimensiones pieds de soutien Dimensioni piedi di appoggio							Shaft projection Saillie d'arbre Sporgenza d'albero				
		DNa	DNm	r	s	a	f	h1	h2	l2	o2	b	m1	m2	n1	n2	k	w	s1	s2	d	l	T
		[mm]																					
NCD(S)2P32-125	26	50	32	10	10	80	360	112	140	97	93	50	100	70	190	140	110	260	ø 14	ø 14	24	50	50
NCD(S)2P32-160	33	50	32	10	10	80	360	132	160	120	120	50	100	70	240	190	110	260	ø 14	ø 14	24	50	50
NCD(S)2P32L-160	31	50	32	10	10	80	360	132	160	120	120	50	100	70	240	190	110	260	ø 14	ø 14	24	50	50
NCD(S)2P32L-200	40	50	32	10	10	80	360	160	180	140	140	50	100	70	265	212	110	260	ø 14	ø 14	24	50	50
NCD(S)2P32-200	38	50	32	10	10	80	360	160	180	140	140	50	100	70	240	190	110	260	ø 14	ø 14	24	50	50
NCD(S)2P40-125	28	65	40	10	10	80	360	112	140	113	100	50	100	70	210	160	110	260	ø 14	ø 14	24	50	65
NCD(S)2P40-160	33	65	40	10	10	80	360	132	160	119	119	50	100	70	240	190	110	260	ø 14	ø 14	24	50	65
NCD(S)2P40-200	40	65	40	10	10	100	360	160	180	140	140	50	100	70	265	212	110	260	ø 14	ø 14	24	50	65
NCD(S)2P40-250	55	65	40	10	10	100	360	180	225	175	175	65	125	95	320	250	110	260	ø 14	ø 14	24	50	65
NCD(S)2P50-125	34	65	50	10	10	100	360	132	160	137	121	50	100	70	240	190	110	260	ø 14	ø 14	24	50	65
NCD(S)2P50-160	33	65	50	10	10	100	360	160	180	141	127	50	100	70	265	212	110	260	ø 14	ø 14	24	50	65
NCD(S)2P50-200	44	65	50	10	10	100	360	160	200	153	140	50	100	70	265	212	110	260	ø 14	ø 14	24	50	65
NCD(S)2P50-250	57	65	50	10	10	100	360	180	225	175	175	65	125	95	320	250	110	260	ø 14	ø 14	24	50	65
NCD(S)2P65-125	38	80	65	10	10	100	360	160	180	155	134	65	125	95	280	212	110	260	ø 14	ø 14	24	50	80
NCD(S)2P65-160	40	80	65	10	10	100	360	160	200	172	150	65	125	95	280	212	110	260	ø 14	ø 14	24	50	80
NCD(S)2P65-200	48	80	65	10	10	100	360	180	225	175	155	65	125	95	320	250	110	260	ø 14	ø 14	24	50	80
NCD(S)2P65-250	88	80	65	10	10	100	470	200	250	190	175	80	160	120	360	280	110	340	ø 18	ø 14	24	50	80
NCD(S)2P80-160	48	100	80	10	10	125	360	180	225	193	165	65	125	95	320	250	110	260	ø 14	ø 14	24	50	100
NCD(S)2P80-200	80	100	80	10	10	125	470	180	250	194	170	65	125	95	345	280	110	340	ø 14	ø 14	32	80	100
NCD(S)2P80-250	92	100	80	10	10	125	470	200	280	210	191	80	160	120	400	315	110	340	ø 18	ø 14	32	80	100
NCD(S)2P100-200	83	125	100	10	10	125	470	200	280	212	180	80	160	120	360	280	110	340	ø 18	ø 14	32	80	125
NCD(S)2P100-250	103	125	100	10	10	140	470	225	280	233	205	80	160	120	400	315	110	340	ø 18	ø 14	32	80	125
NCD(S)4P32-125	25	50	32	10	10	80	360	112	140	97	93	50	100	70	190	140	110	260	ø 14	ø 14	24	50	50
NCD(S)4P32-160	33	50	32	10	10	80	360	132	160	120	120	50	100	70	240	190	110	260	ø 14	ø 14	24	50	50
NCD(S)4P32-200	37	50	32	10	10	80	360	160	180	140	140	50	100	70	240	190	110	260	ø 14	ø 14	24	50	50
NCD(S)4P40-160	33	65	40	10	10	80	360	132	160	119	119	50	100	70	240	190	110	260	ø 14	ø 14	24	50	65
NCD(S)4P40-200	40	65	40	10	10	100	360	160	180	140	140	50	100	70	265	212	110	260	ø 14	ø 14	24	50	65
NCD(S)4P40-250	55	65	40	10	10	100	360	180	225	175	175	65	125	95	320	250	110	260	ø 14	ø 14	24	50	65
NCD(S)4P50-125	34	65	50	10	10	100	360	132	160	137	121	50	100	70	240	190	110	260	ø 14	ø 14	24	50	65
NCD(S)4P50-160	33	65	50	10	10	100	360	160	180	141	127	50	100	70	265	212	110	260	ø 14	ø 14	24	50	65
NCD(S)4P50-200	44	65	50	10	10	100	360	160	200	153	140	50	100	70	265	212	110	260	ø 14	ø 14	24	50	65
NCD(S)4P50-250	57	65	50	10	10	100	360	180	225	175	175	65	125	95	320	250	110	260	ø 14	ø 14	24	50	65
NCD(S)4P65-125	38	80	65	10	10	100	360	160	180	155	134	65	125	95	280	212	110	260	ø 14	ø 14	24	50	80
NCD(S)4P65-160	40	80	65	10	10	100	360	160	200	172	150	65	125	95	280	212	110	260	ø 14	ø 14	24	50	80
NCD(S)4P65-200	48	80	65	10	10	100	360	180	225	175	155	65	125	95	320	250	110	260	ø 14	ø 14	24	50	80
NCD(S)4P65-250	89	80	65	10	10	100	470	200	250	190	175	80	160	120	360	280	110	340	ø 18	ø 14	24	50	80
NCD(S)4P65-315	131	80	65	10	10	125	470	225	280	220	220	80	160	120	400	315	110	340	ø 18	ø 14	32	80	80
NCD(S)4P80-160	48	100	80	10	10	125	360	180	225	193	165	65	125	95	320	250	110	260	ø 14	ø 14	24	50	100
NCD(S)4P80-200	80	100	80	10	10	125	470	180	250	194	170	65	125	95	345	280	110	340	ø 14	ø 14	32	80	100
NCD(S)4P80-250	92	100	80	10	10	125	470	200	280	210	191	80	160	120	400	315	110	340	ø 18	ø 14	32	80	100
NCD(S)4P80-315	128	100	80	10	10	125	470	250	315	232	220	80	160	120	400	315	110	340	ø 18	ø 14	32	80	100
NCD(S)4P80-400	184	100	80	10	10	125	530	280	355	268	268	80	160	120	435	355	110	370	ø 18	ø 14	42	110	100
NCD(S)4P100-200	83	125	100	10	10	125	470	200	280	212	180	80	160	120	360	280	110	340	ø 18	ø 14	32	80	125
NCD(S)4P100-250	103	125	100	10	10	140	470	225	280	233	205	80	160	120	400	315	110	340	ø 18	ø 14	32	80	125
NCD(S)4P100-315	138	125	100	10	10	140	470	250	315	250	230	80	160	120	400	315	110	340	ø 18	ø 14	32	80	125

Selection - dimensions and weights for base mounted electric pumps  
 Sélection - dimensions et poids des électropompes sur socle  
 Selezione - dimensioni e pesi elettropompe su base

COUPLINGS WITH STANDARDIZED ENCLOSED ELECTRIC MOTORS  
 ACCOUPLEMENTS AVEC MOTEURS ÉLECTRIQUES FERMÉS NORMALISÉS  
 ACCOPIAMENTI CON MOTORI ELETTRICI CHIUSI NORMALIZZATI

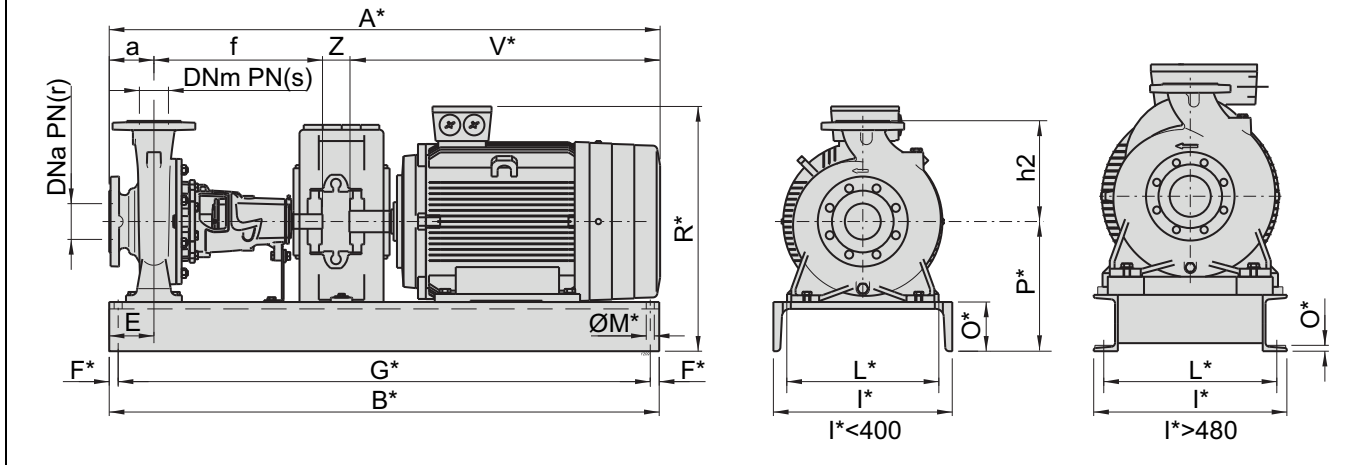

Pump Pompe Pompa		Motor Moteur Motore		Weight Poids Peso	BGAD	A*	B*	E	F*	G*	I*	L*	M*	O*	P*	R*	V*	Z	a	f	h2	r	s		
Type Type Tipo	DNa [mm]	DNm [mm]	[kW]	Size Taille Grand.	[kg]	Type Type Tipo	[mm]																		
NCDS4P32-200	50	32	0,75	80M4	81	1011	773	780	90	15	750	240	180	ø 14	85	245	370	295	38	80	360	180	10	10	
NCDS4P40-160	65	40	0,75	80M4	75	1016	773	780	90	15	750	240	180	ø 14	85	217	342	295	38	80	360	160	10	10	
NCDS4P40-200	65	40	1,1	90S4	101	1020	853	880	100	15	850	300	240	ø 14	100	260	398	355	38	100	360	180	10	10	
NCDS4P40-250	65	40	3	100L4	146	1023	914	880	100	15	850	350	290	ø 14	100	280	430	405	49	100	360	225	10	10	
NCDS4P50-160	65	50	1,1	90S4	95	1020	853	880	100	15	850	300	240	ø 14	100	260	398	355	38	100	360	180	10	10	
NCDS4P50-200	65	50	2,2	100L4	118	1009	914	880	90	15	850	300	240	ø 14	100	260	410	405	49	100	360	200	10	10	
NCDS4P50-250	65	50	4	112M4	155	1025	949	880	100	15	850	350	290	ø 14	100	280	452	440	49	100	360	225	10	10	
NCDS4P65-125	80	65	1,1	90S4	99	1020	853	880	100	15	850	300	240	ø 14	100	260	398	355	38	100	360	180	10	10	
NCDS4P65-160	80	65	1,5	90L4	105	1020	883	880	100	15	850	300	240	ø 14	100	260	398	385	38	100	360	200	10	10	
NCDS4P65-200	80	65	3	100L4	139	1023	914	880	100	15	850	350	290	ø 14	100	280	430	405	49	100	360	225	10	10	
NCDS4P65-250	80	65	5,5	132S4	220	1032	1045	1030	130	20	990	400	340	ø 18	110	310	502	455	20	100	470	250	10	10	
NCDS4P65-315	80	65	11	160M4	372	1034	1226	1230	130	20	1190	400	340	ø 18	110	335	586	627	4	125	470	280	10	10	
NCDS4P80-160	100	80	2,2	100L4	135	1023	939	880	100	15	850	350	290	ø 14	100	280	430	405	49	125	360	225	10	10	
NCDS4P80-200	100	80	4	112M4	188	1039	1084	1020	100	15	990	350	290	ø 14	100	280	452	440	49	125	470	250	10	10	
NCDS4P80-250	100	80	7,5	132M4	230	1032	1105	1030	130	20	990	400	340	ø 18	110	310	502	490	20	125	470	280	10	10	
NCDS4P80-315	100	80	15	160L4	384	1043	1226	1230	130	20	1190	400	340	ø 18	110	360	611	627	4	125	470	315	10	10	
NCDS4P80-400	100	80	30	200L4	559	1046	1440	1250	115	205	840	480	430	ø 24	16	445	745	758	27	125	530	355	10	10	
NCDS4P100-200	125	100	5,5	132S4	214	1032	1070	1030	130	20	990	400	340	ø 18	110	310	502	455	20	125	470	280	10	10	
NCDS4P100-250	125	100	11	160M4	346	1034	1241	1230	130	20	1190	400	340	ø 18	110	335	586	627	4	140	470	280	10	10	
NCDS4P100-315	125	100	18,5	180M4	444	1044	1335	1360	130	20	1320	400	340	ø 18	110	360	630	665	60	140	470	315	10	10	
NCDS4P100-400	125	100	37	225S4	619	1055	1467	1250	115	205	840	480	430	ø 24	16	445	775	793	4	140	530	355	10	10	
NCDS4P125-250	150	125	15	160L4	377	1043	1241	1230	130	20	1190	400	340	ø 18	110	360	611	627	4	140	470	355	10	10	
NCDS4P125-315	150	125	30	200L4	561	1054	1455	1250	115	205	840	480	430	ø 24	16	445	745	758	27	140	530	355	10	10	
NCDS4P125-400	150	125	55	250M4	843	1058	1554	1400	115	230	940	510	450	ø 24	17,5	540	915	880	4	140	530	400	10	10	
NCDS4P150-315	200	150	37	225S4	623	1061	1487	1250	115	205	840	480	430	ø 24	16	445	775	793	4	160	530	400	10	10	
NCDS4P150-400	200	150	75	280S4	936	1064	1714	1400	115	230	940	510	450	ø 24	17,5	540	930	1020	4	160	530	450	10	10	

BGAD = Base and coupling

\* = Indicatives values according to the type of motor installed.

BGAD = Socle et accouplement

\* = Valeurs indicatives en fonction de la marque du moteur utilisé.

BGAD = Base e giunto

\* = Valori indicativi in funzione della marca di motore utilizzato.