

Utilization field Champ d'utilisation Campo di utilizzo ≥ 60% η		
Stage number: compatibly with the maximum pressure. Nombre d'étages: compatible avec la pression maximum. Numero stadi: compatibilmente con la pressione massima di esercizio.		
Type Type Tipo	MIN.	MAX.
PM	2	16
PMS	2	16
PMH	6	16
NB. For two-stage pumps only, reduce efficiency by one point. Diminuer le rendement d'un point seulement pour les pompes à deux étages. Solamente per le pompe a due stadi, ridurre di un punto il rendimento.		

Wet moment of inertia J Moment d'inertie J mouillé Momento d'inerzia J bagnato J=1/4PD ² - [kg m ²]		
Impeller type Roue type Girante tipo	PM(S/H)65/1	For each additional stage Pour chaque étage en plus Per ogni stadio in più
Cast iron Fonte Ghisa	0,0130	0,0107
Bronze Bronze Bronzo	0,0143	0,012

Maximum permissible power Puissances maximums admissibles Massime potenze ammissibili	
Type Type Tipo	N/n MAX.
PM	0,05
PMS	0,05
PMH	0,08
For seal limits and calculation formulas of the maximum permissible powers, see technical data section. Consulter la section Données techniques pour connaître les limites des joints et les formules pour le calcul des puissances maximales admises. Per i limiti tenute e le formule di calcolo delle massime potenze ammissibili, vedere sezione dati tecnici.	

PERFORMANCES EACH INTERMEDIATE STAGE
CARACTERISTIQUES POUR CHAQUE ETAGE
PRESTAZIONI PER STADIO

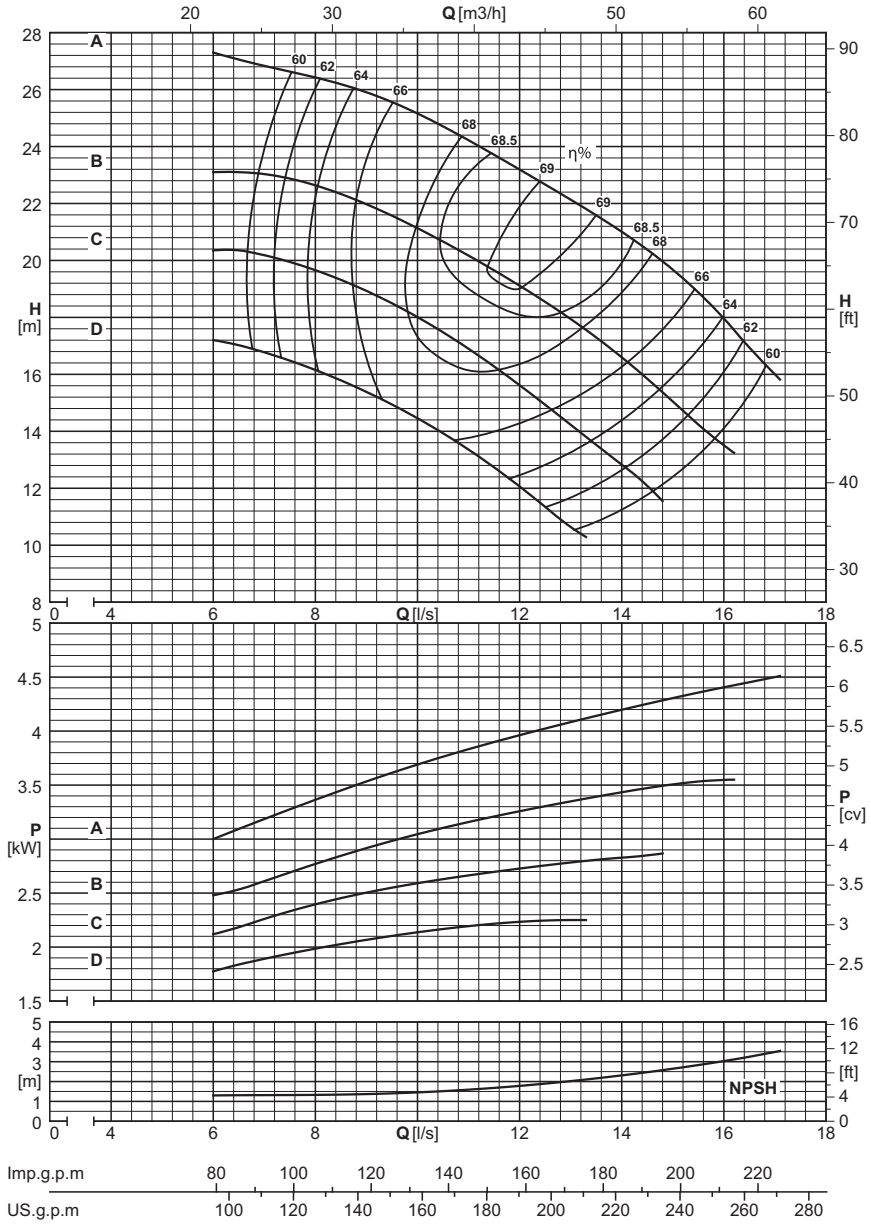

		Capacity - Debit - Portata																										
Dna x DNm	Impeller type Roue type Girante tipo	[l/s]	0	7	7,5	8	8,5	9	9,5	10	10,5	11	11,5	12	12,5	13	13,5	14	14,5	15	15,5	16	16,5	17				
		[m³/h]	0	25,2	27	28,8	30,6	32,4	34,2	36	37,8	39,6	41,4	43,2	45	46,8	48,6	50,4	52,2	54	55,8	57,6	59,4	61,2				
		[l/min]	0	420	450	480	510	540	570	600	630	660	690	720	750	780	810	840	870	900	930	960	990	1020				
PM(S/H)65/1																												
80x65	D	[m]	16	17	16,5	16,5	16,5	15,5	15	14,5	14,5	13,5	13	12	11,5	10,5	10											
80x65	D	[kW]		1,9	1,9	2	2	2,1	2,1	2,2	2,2	2,2	2,2	2,2	2,2	2,3	2,3											
80x65	C	[m]	18,5	20	19,5	19,5	20	18,5	18,5	18	17,5	17	16,5	15,5	15	14	13,5	13	12	11,5								
80x65	C	[kW]		2,3	2,4	2,4	2,5	2,5	2,5	2,6	2,6	2,6	2,7	2,7	2,8	2,8	2,8	2,8	2,9	2,9								
80x65	B	[m]	22	23,5	23	23,5	22,5	22,5	22	21	20,5	20	19,5	19	18,5	18	17,5	16,5	16	15,5	14	13,5	13,5					
80x65	B	[kW]		2,6	2,7	2,7	2,8	2,9	2,9	3,1	3,1	3,2	3,2	3,3	3,3	3,4	3,4	3,4	3,5	3,5	3,5	3,5	3,6					
80x65	A	[m]	27,5	27,5	27,5	25,5	26	25,5	25,5	25,5	25	24,5	23,5	23,5	22,5	22	21,5	21	20,5	19,5	19	19	17	16				
80x65	A	[kW]		3,1	3,2	3,4	3,5	3,6	3,6	3,7	3,7	3,8	3,9	4	4	4,1	4,1	4,2	4,2	4,3	4,4	4,4	4,4	4,5				
NPSH																												
		[m]		1,3	1,3	1,3	1,4	1,4	1,4	1,5	1,5	1,6	1,7	1,8	1,9	2	2,2	2,3	2,5	2,7	2,8	3	3,3	3,5				

Overall dimensions and weights
 Dimensions d'encombrement et poids
 Dimensioni di ingombro e pesi

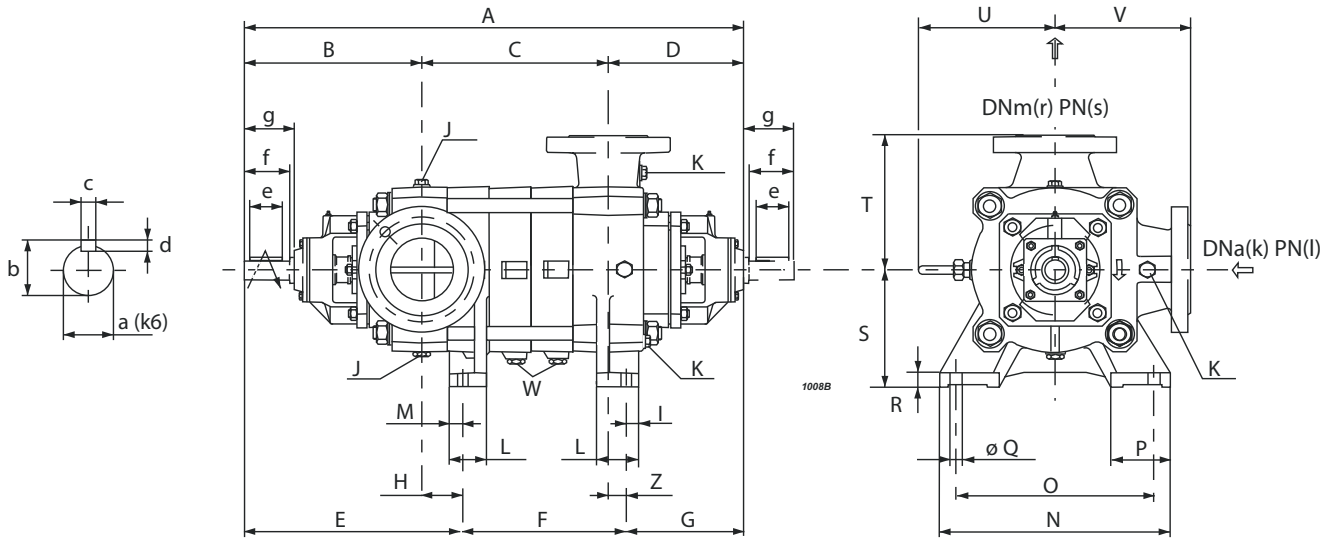

Series Série Serie	Type Type Tipo	A	B	C	D	E	F	G	H	S	T	U	V	Z	Weight Poids Peso
		[mm]													
PM(S)	65/2	688	289	170	229	354	135	199	65	180	220	239	220	30	116
PM(S)	65/3	753	289	235	229	354	200	199	65	180	220	239	220	30	130
PM(S)	65/4	818	289	300	229	354	265	199	65	180	220	239	220	30	144
PM(S)	65/5	883	289	365	229	354	330	199	65	180	220	239	220	30	158
PM(S/H)	65/6	948	289	430	229	354	395	199	65	180	220	239	220	30	172
PM(S/H)	65/7	1013	289	495	229	354	460	199	65	180	220	239	220	30	186
PM(S/H)	65/8	1078	289	560	229	354	525	199	65	180	220	239	220	30	200
PM(S/H)	65/9	1143	289	625	229	354	590	199	65	180	220	239	220	30	214
PM(S/H)	65/10	1208	289	690	229	354	655	199	65	180	220	239	220	30	228
PM(S/H)	65/11	1273	289	755	229	354	720	199	65	180	220	239	220	30	242
PM(S/H)	65/12	1338	289	820	229	354	785	199	65	180	220	239	220	30	256
PM(S/H)	65/13	1403	289	885	229	354	850	199	65	180	220	239	220	30	270
PM(S/H)	65/14	1468	289	950	229	354	915	199	65	180	220	239	220	30	284
PM(S/H)	65/15	1533	289	1015	229	354	980	199	65	180	220	239	220	30	298
PM(S/H)	65/16	1598	289	1080	229	354	1045	199	65	180	220	239	220	30	312

Foot dimensions Dimensions des pieds Dimensioni dei piedi							
I	L	M	N	O	P	Q	R
[mm]							
20	65	21	370	320	90	18	23

Shaft projection Saille d'arbre Sporgenza d'albero							
a	b	c	d	e	f	g	
[mm]							
32	35	10	8	60	75	90	

Type Type Tipo	Flanges Brides Flange			
	(k) DNa	(l) PN	(r) DNm	(s) PN
	[mm]	[bar]	[mm]	[bar]
PM	80	25	65	40
PMS	80	25	65	63
PMH	80	40	65	100

Plugs Bouchons Tappi		
J	K	W
G 1/2	G 3/8	G 1/4

Selection - dimensions and weights for base mounted electric pumps
 Sélection - dimensions et poids des électropompes sur socle
 Selezione - dimensioni e pesi elettropompe su base

COUPLINGS WITH STANDARDIZED ENCLOSED ELECTRIC MOTORS
 ACCOUPLEMENTS AVEC MOTEURS ÉLECTRIQUES FERMÉS NORMALISÉS
 ACCOPIAMENTI CON MOTORI ELETTRICI CHIUSI NORMALIZZATI

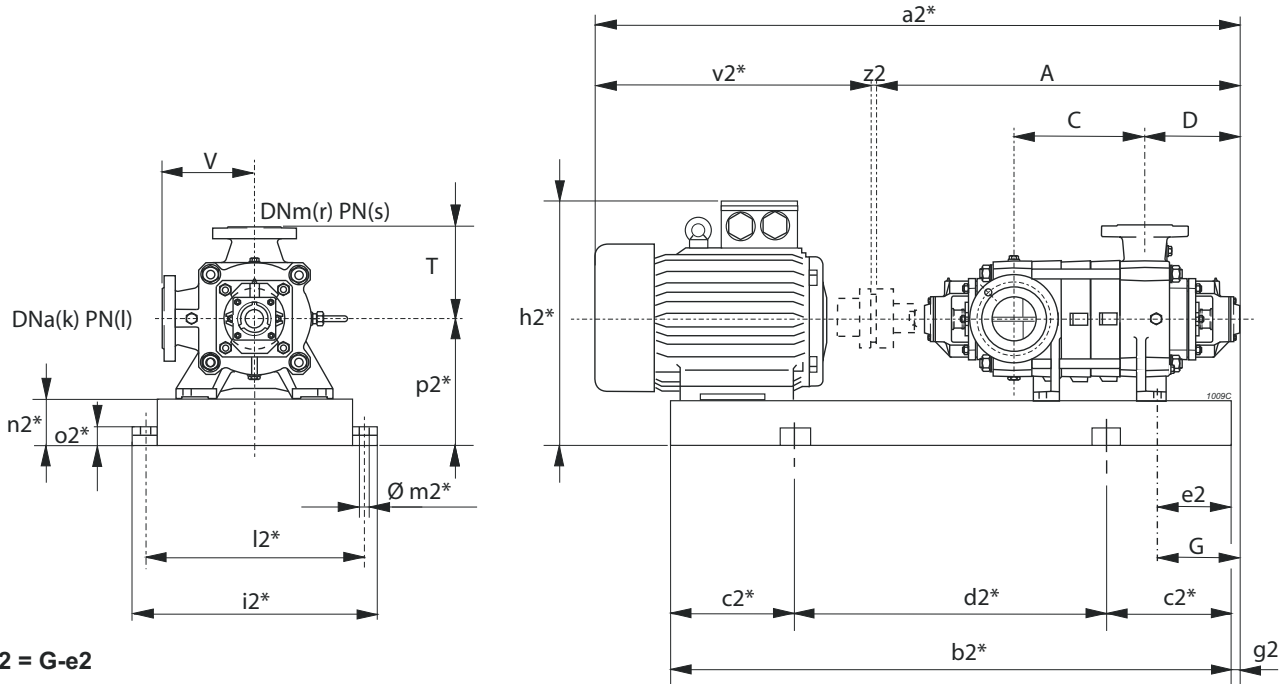

$g2 = G - e2$

* Valori indicativi in funzione della marca di motore utilizzato
 Indicatives values according to the type of motor installed

Pump Pompe Pompa	Motor Moteur Motore	BGAM	A	C	D	G	T	V	a2*	b2*	c2*	d2*	e2	h2*	i2*	k	l	l2*	m2*	n2*	o2*	p2*	r	s	v2*	z2	Weight Poids Peso		
Series Série Serie	Type Type Tipo	[kW]	Size Taille Grand.	Type Type Tipo	[mm]																				[kg]				
PM(S)	65/2	11	160M	411/DM	687,5	170	229	199	220	220	1318,5	1026	150	726	40	531	500	80	(1)	450	20	100	42	280	65	(2)	627	4	284
PM(S)	/2	15	160M	411/DM	687,5	170	229	199	220	220	1318,5	1026	150	726	40	531	500	80	(1)	450	20	100	42	280	65	(2)	627	4	295
PM(S)	/2	18,5	160L	412/DM	687,5	170	229	199	220	220	1318,5	1070	200	670	40	531	500	80	(1)	450	20	100	42	280	65	(2)	627	4	308
PM(S)	/2	22	180M	413/EM	687,5	170	229	199	220	220	1356,5	1080	200	680	40	550	500	80	(1)	450	20	100	42	280	65	(2)	665	4	348
PM(S)	65/3	15	160M	414/DM	752,5	235	229	199	220	220	1383,5	1091	200	691	40	531	500	80	(1)	450	20	100	42	280	65	(2)	627	4	311
PM(S)	/3	18,5	160L	415/DM	752,5	235	229	199	220	220	1383,5	1135	200	735	40	531	500	80	(1)	450	20	100	42	280	65	(2)	627	4	323
PM(S)	/3	22	180M	416/EM	752,5	235	229	199	220	220	1421,5	1145	200	745	40	550	500	80	(1)	450	20	100	42	280	65	(2)	665	4	363
PM(S)	/3	30	200L	417/FM	752,5	235	229	199	220	220	1494,5	1238	200	838	60	600	540	80	(1)	490	20	100	42	300	65	(2)	738	4	425
PM(S)	/3	37	200L	417/FM	752,5	235	229	199	220	220	1494,5	1238	200	838	60	600	540	80	(1)	490	20	100	42	300	65	(2)	738	4	453
PM(S)	65/4	18,5	160L	418/DM	817,5	300	229	199	220	220	1448,5	1200	200	800	40	531	500	80	(1)	450	20	100	42	280	65	(2)	627	4	339
PM(S)	/4	22	180M	419/EM	817,5	300	229	199	220	220	1486,5	1210	200	810	40	550	500	80	(1)	450	20	100	42	280	65	(2)	665	4	379
PM(S)	/4	30	200L	420/FM	817,5	300	229	199	220	220	1559,5	1303	200	903	60	600	540	80	(1)	490	20	100	42	300	65	(2)	738	4	440
PM(S)	/4	37	200L	420/FM	817,5	300	229	199	220	220	1559,5	1303	200	903	60	600	540	80	(1)	490	20	100	42	300	65	(2)	738	4	468
PM(S)	/4	45	225M	421/FM	817,5	300	229	199	220	220	1596,5	1339	200	939	70	675	585	80	(1)	535	20	120	42	345	65	(2)	775	4	544
PM(S)	65/5	22	180M	422/EM	882,5	365	229	199	220	220	1551,5	1275	200	875	40	550	500	80	(1)	450	20	100	42	280	65	(2)	665	4	394
PM(S)	/5	30	200L	423/FM	882,5	365	229	199	220	220	1624,5	1368	250	968	60	600	540	80	(1)	490	20	100	42	300	65	(2)	738	4	456
PM(S)	/5	37	200L	423/FM	882,5	365	229	199	220	220	1624,5	1368	250	968	60	600	540	80	(1)	490	20	100	42	300	65	(2)	738	4	484
PM(S)	/5	45	225M	424/FM	882,5	365	229	199	220	220	1661,5	1404	250	904	70	675	585	80	(1)	535	20	120	42	345	65	(2)	775	4	560
PM(S)	/5	55	250M	425/GM	882,5	365	229	199	220	220	1756,5	1486	250	986	80	745	635	80	(1)	585	20	120	42	370	65	(2)	870	4	670
PM(S/H)	65/6	30	200L	426/FM	947,5	430	229	199	220	220	1689,5	1433	250	933	60	600	540	80	(1)	490	20	100	42	300	65	(2)	738	4	471
PM(S/H)	/6	37	200L	426/FM	947,5	430	229	199	220	220	1689,5	1433	250	933	60	600	540	80	(1)	490	20	100	42	300	65	(2)	738	4	499
PM(S/H)	/6	45	225M	427/FM	947,5	430	229	199	220	220	1726,5	1469	250	969	70	675	585	80	(1)	535	20	120	42	345	65	(2)	775	4	576
PM(S/H)	/6	55	250M	428/GM	947,5	430	229	199	220	220	1821,5	1551	250	1051	80	745	635	80	(1)	585	20	120	42	370	65	(2)	870	4	686
PM(S/H)	/6	75	280S	429/HM	947,5	430	229	199	220	220	1951,5	1608	250	1108	90	815	695	80	(1)	645	20	140	42	420	65	(2)	1000	4	916
PM(S/H)	65/7	30	200L	430/FM	1012,5	495	229	199	220	220	1754,5	1498	250	998	60	600	540	80	(1)	490	20	100	42	300	65	(2)	738	4	487
PM(S/H)	/7	37	200L	430/FM	1012,5	495	229	199	220	220	1754,5	1498	250	998	60	600	540	80	(1)	490	20	100	42	300	65	(2)	738	4	515
PM(S/H)	/7	45	225M	431/FM	1012,5	495	229	199	220	220	1791,5	1534	250	1034	70	675	585	80	(1)	535	20	120	42	345	65	(2)	775	4	591
PM(S/H)	/7	55	250M	432/GM	1012,5	495	229	199	220	220	1886,5	1616	250	1116	80	745	635	80	(1)	585	20	120	42	370	65	(2)	870	4	701
PM(S/H)	/7	75	280S	433/HM	1012,5	495	229	199	220	220	2016,5	1673	300	1073	90	815	695	80	(1)	645	20	140	42	420	65	(2)	1000	4	932
PM(S/H)	/7	90	280M	434/HM	1012,5	495	229	199	220	220	2067,5	1724	300	1124	90	815	695	80	(1)	645	20	140	42	420	65	(2)	1051	4	1061

BGAM = Base and coupling

* = Indicatives values according to the type of motor installed.

○ Motor in IE4 efficiency class according to EU REGULATION 2019/1781. Available in other efficiency classes for non-EU markets.

(1) PM=25 bar PMS=25 bar PMH=40 bar

(2) PM=40 bar PMS=63 bar PMH=100 bar

BGAM = Socle et accouplement

* = Valeurs indicatives en fonction de la marque du moteur utilisé.

○ Moteur en classe de rendement IE4 conformément au RÈGLEMENT UE2019/1781. Disponibilité en différentes classes de rendement pour les marchés hors UE.

(1) PM=25 bar PMS=25 bar PMH=40 bar

(2) PM=40 bar PMS=63 bar PMH=100 bar

BGAM = Base giunto e coprigiunto

* = Valori indicativi in funzione della marca di motore utilizzato.

○ Motore in classe di efficienza IE4 in conformità al REGOLAMENTO UE2019/1781. Disponibili in altre classi di efficienza per mercati extra UE.

(1) PM=25 bar PMS=25 bar PMH=40 bar

(2) PM=40 bar PMS=63 bar PMH=100 bar

Selection - dimensions and weights for base mounted electric pumps
 Sélection - dimensions et poids des électropompes sur socle
 Selezione - dimensioni e pesi elettropompe su base

COUPLINGS WITH STANDARDIZED ENCLOSED ELECTRIC MOTORS
 ACCOUPLEMENTS AVEC MOTEURS ÉLECTRIQUES FERMÉS NORMALISÉS
 ACCOPIAMENTI CON MOTORI ELETTRICI CHIUSI NORMALIZZATI

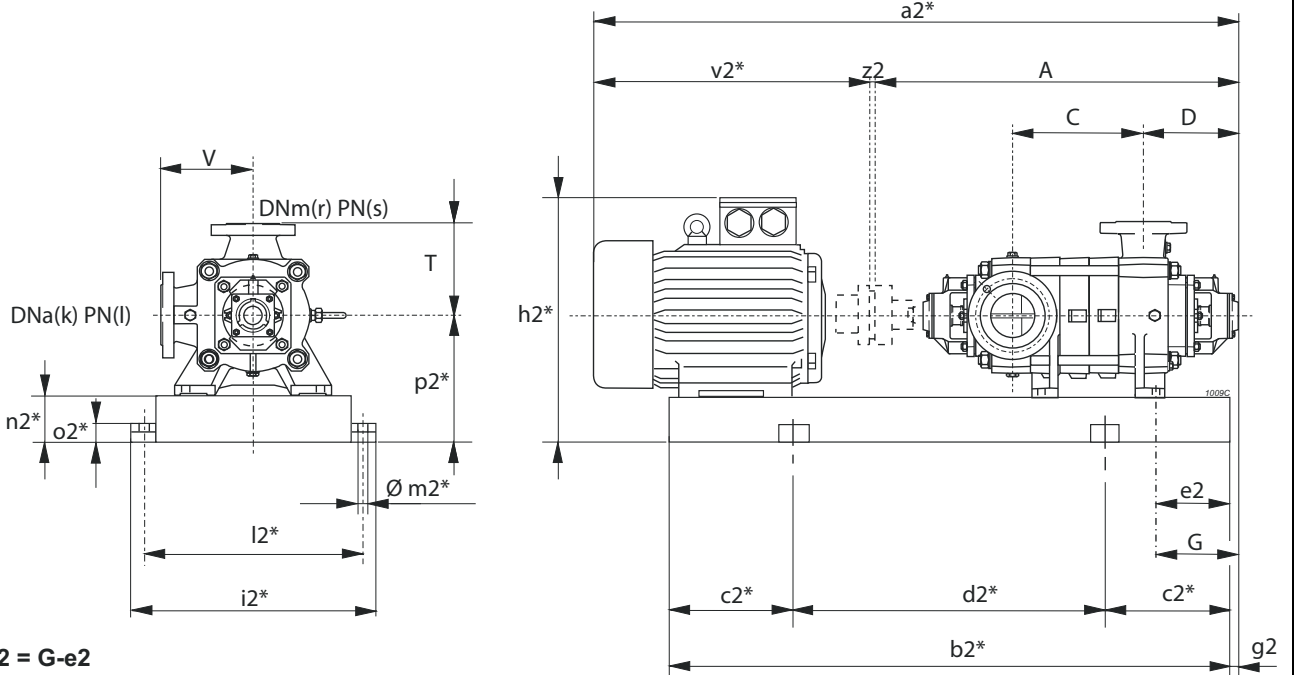

$g2 = G - e2$

* Valori indicativi in funzione della marca di motore utilizzato
 Indicatives values according to the type of motor installed

Pump Pompe Pompa	Motor Moteur Motore	BGAM	A	C	D	G	T	V	a2*	b2*	c2*	d2*	e2	h2*	i2*	k	l	l2*	m2*	n2*	o2*	p2*	r	s	v2*	z2	Weight Poids Peso		
Series Série Serie	Type Type Tipo	[kW]	Size Taille Grand.	Type Type Tipo	[mm]																				[kg]				
PM(S/H)	65/8	37	200L	435/FM	1077,5	560	229	199	220	220	1819,5	1563	250	1063	60	600	540	80	(1)	490	20	100	42	300	65	(2)	738	4	530
PM(S/H)	/8	45	225M	436/FM	1077,5	560	229	199	220	220	1856,5	1599	250	1099	70	675	585	80	(1)	535	20	120	42	345	65	(2)	775	4	607
PM(S/H)	/8	55	250M	437/GM	1077,5	560	229	199	220	220	1951,5	1681	300	1081	80	745	635	80	(1)	585	20	120	42	370	65	(2)	870	4	717
PM(S/H)	/8	75	280S	438/HM	1077,5	560	229	199	220	220	2081,5	1738	300	1138	90	815	695	80	(1)	645	20	140	42	420	65	(2)	1000	4	948
PM(S/H)	/8	90	280M	439/HM	1077,5	560	229	199	220	220	2132,5	1789	300	1189	90	815	695	80	(1)	645	20	140	42	420	65	(2)	1051	4	1077
PM(S/H)	65/9	45	225M	440/FM	1142,5	625	229	199	220	220	1921,5	1664	300	1064	70	675	585	80	(1)	535	20	120	42	345	65	(2)	775	4	623
PM(S/H)	/9	55	250M	441/GM	1142,5	625	229	199	220	220	2016,5	1746	300	1146	80	745	635	80	(1)	585	20	120	42	370	65	(2)	870	4	733
PM(S/H)	/9	75	280S	442/HM	1142,5	625	229	199	220	220	2146,5	1803	300	1203	90	815	695	80	(1)	645	20	140	42	420	65	(2)	1000	4	964
PM(S/H)	/9	90	280M	443/HM	1142,5	625	229	199	220	220	2197,5	1854	300	1254	90	815	695	80	(1)	645	20	140	42	420	65	(2)	1051	4	1093
PM(S/H)	/9	110	315S	444/IM	1142,5	625	229	199	220	220	2327,5	1910	300	1310	100	1030	780	80	(1)	730	22	160	50	475	65	(2)	1181	4	1369
PM(S/H)	65/10	45	225M	445/FM	1207,5	690	229	199	220	220	1986,5	1729	300	1129	70	675	585	80	(1)	585	20	120	42	345	65	(2)	775	4	639
PM(S/H)	/10	55	250M	446/GM	1207,5	690	229	199	220	220	2081,5	1811	300	1211	80	745	635	80	(1)	535	20	120	42	370	65	(2)	870	4	748
PM(S/H)	/10	75	280S	447/HM	1207,5	690	229	199	220	220	2211,5	1868	300	1268	90	815	695	80	(1)	645	20	140	42	420	65	(2)	1000	4	980
PM(S/H)	/10	90	280M	448/HM	1207,5	690	229	199	220	220	2262,5	1919	300	1319	90	815	695	80	(1)	645	20	140	42	420	65	(2)	1051	4	1109
PM(S/H)	/10	110	315S	449/IM	1207,5	690	229	199	220	220	2392,5	1975	350	1275	100	1030	780	80	(1)	730	22	160	50	475	65	(2)	1181	4	1385
PM(S/H)	65/11	55	250M	450/GM	1272,5	755	229	199	220	220	2146,5	1876	300	1276	80	745	635	80	(1)	585	20	120	42	370	65	(2)	870	4	764
PM(S/H)	/11	75	280S	451/HM	1272,5	755	229	199	220	220	2276,5	1933	300	1333	90	815	695	80	(1)	645	20	140	42	420	65	(2)	1000	4	996
PM(S/H)	/11	90	280M	452/HM	1272,5	755	229	199	220	220	2327,5	1984	350	1284	90	815	695	80	(1)	645	20	140	42	420	65	(2)	1051	4	1125
PM(S/H)	/11	110	315S	453/IM	1272,5	755	229	199	220	220	2457,5	2040	350	1340	100	1030	780	80	(1)	730	22	160	50	475	65	(2)	1181	4	1331
PM(S/H)	/11	132	315M	454/IM	1272,5	755	229	199	220	220	2567,5	2099	350	1399	100	1030	780	80	(1)	730	22	160	50	475	65	(2)	1291	4	1403
PM(S/H)	65/12	55	250M	455/GM	1337,5	820	229	199	220	220	2211,5	1941	300	1341	80	745	635	80	(1)	585	20	120	42	370	65	(2)	870	4	780
PM(S/H)	/12	75	280S	456/HM	1337,5	820	229	199	220	220	2341,5	1998	350	1298	90	815	695	80	(1)	645	20	140	42	420	65	(2)	1000	4	1012
PM(S/H)	/12	90	280M	457/HM	1337,5	820	229	199	220	220	2392,5	2049	350	1349	90	815	695	80	(1)	645	20	140	42	420	65	(2)	1051	4	1141
PM(S/H)	/12	110	315S	458/IM	1337,5	820	229	199	220	220	2522,5	2105	350	1405	100	1030	780	80	(1)	730	22	160	50	475	65	(2)	1181	4	1345
PM(S/H)	/12	132	315M	459/IM	1337,5	820	229	199	220	220	2632,5	2164	350	1464	100	1030	780	80	(1)	730	22	160	50	475	65	(2)	1291	4	1417
PM(S/H)	65/13	75	280S	460/HM	1402,5	885	229	199	220	220	2406,5	2063	350	1363	90	815	695	80	(1)	645	20	140	42	420	65	(2)	1000	4	1028
PM(S/H)	/13	90	280M	461/HM	1402,5	885	229	199	220	220	2457,5	2114	350	1414	90	815	695	80	(1)	645	20	140	42	420	65	(2)	1051	4	1157
PM(S/H)	/13	110	315S	462/IM	1402,5	885	229	199	220	220	2587,5	2170	350	1470	100	1030	780	80	(1)	730	22	160	50	475	65	(2)	1181	4	1434
PM(S/H)	/13	132	315M	463/IM	1402,5	885	229	199	220	220	2697,5	2280	400	1480	100	1030	780	80	(1)	730	22	160	50	475	65	(2)	1291	4	1511

BGAM = Base and coupling

* = Indicatives values according to the type of motor installed.

○ Motor in IE4 efficiency class according to EU REGULATION 2019/1781. Available in other efficiency classes for non-EU markets.

- (1) PM=25 bar PMS=25 bar PMH=40 bar
- (2) PM=40 bar PMS=63 bar PMH=100 bar

BGAM = Socle et accouplement

* = Valeurs indicatives en fonction de la marque du moteur utilisé.

○ Moteur en classe de rendement IE4 conformément au RÈGLEMENT UE2019/1781. Disponibilité en différentes classes de rendement pour les marchés hors UE.

- (1) PM=25 bar PMS=25 bar PMH=40 bar
- (2) PM=40 bar PMS=63 bar PMH=100 bar

BGAM = Base giunto e coprigiunto

* = Valori indicativi in funzione della marca di motore utilizzato.

○ Motore in classe di efficienza IE4 in conformità al REGOLAMENTO UE2019/1781. Disponibili in altre classi di efficienza per mercati extra UE.

- (1) PM=25 bar PMS=25 bar PMH=40 bar
- (2) PM=40 bar PMS=63 bar PMH=100 bar

Selection - dimensions and weights for base mounted electric pumps
 Sélection - dimensions et poids des électropompes sur socle
 Selezione - dimensioni e pesi elettropompe su base

COUPLINGS WITH STANDARDIZED ENCLOSED ELECTRIC MOTORS
 ACCOUPLEMENTS AVEC MOTEURS ÉLECTRIQUES FERMÉS NORMALISÉS
 ACCOPIAMENTI CON MOTORI ELETTRICI CHIUSI NORMALIZZATI

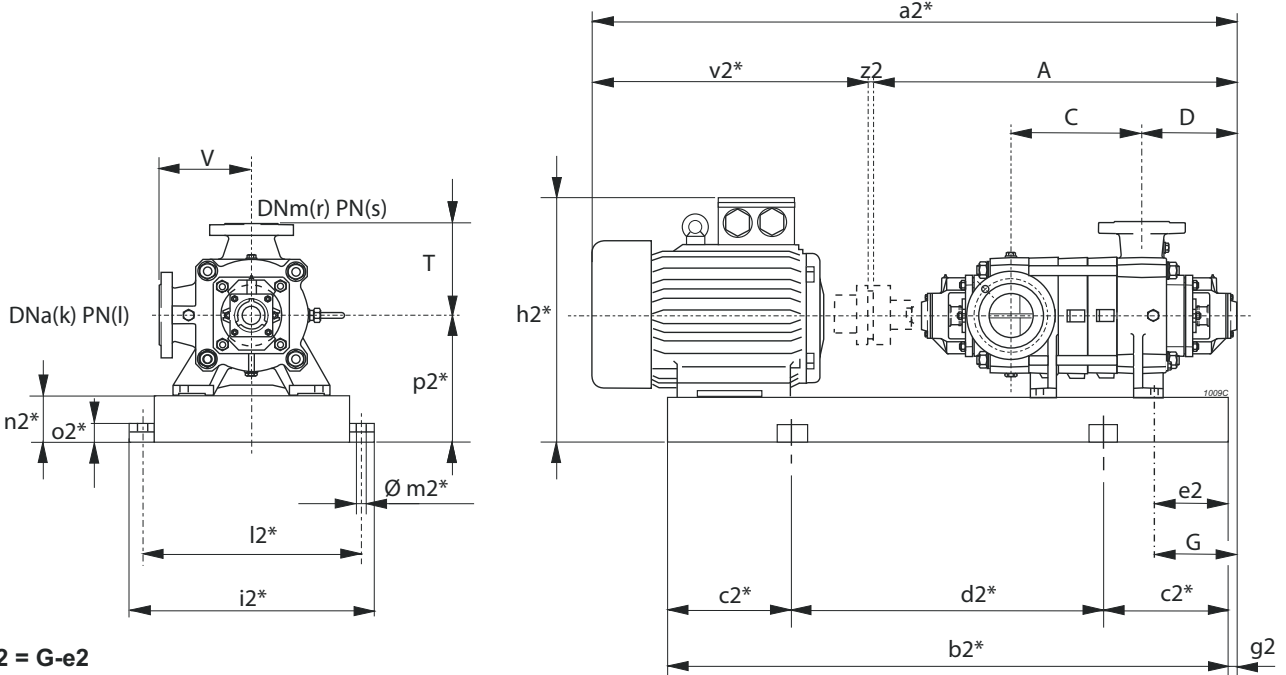

$g2 = G - e2$

* Valori indicativi in funzione della marca di motore utilizzato
 Indicatives values according to the type of motor installed

Pump Pompe Pompa		Motor Moteur Motore		BGAM	A	C	D	G	T	V	a2*	b2*	c2*	d2*	e2	h2*	i2*	k	l	l2*	m2*	n2*	o2*	p2*	r	s	v2*	z2	Weight Poids Peso	
Series Série Serie	Type Type Tipo	[kW]	Size Taille Grand.	Type Type Tipo	[mm]																									[kg]
PM(S/H)	/13	160	315L	463/IM	1402,5	885	229	199	220	220	2697,5	2280	400	1480	100	1030	780	80	(1)	730	22	160	50	475	65	(2)	1291	4	1589	
PM(S/H)	65/14	75	280S	464/HM	1467,5	950	229	199	220	220	2471,5	2128	350	1428	90	815	695	80	(1)	645	20	140	42	420	65	(2)	1000	4	1045	
PM(S/H)	/14	90	280M	465/HM	1467,5	950	229	199	220	220	2522,5	2179	350	1479	90	815	695	80	(1)	645	20	140	42	420	65	(2)	1051	4	1173	
PM(S/H)	/14	110	315S	466/IM	1467,5	950	229	199	220	220	2652,5	2235	350	1535	100	1030	780	80	(1)	730	22	160	50	475	65	(2)	1181	4	1451	
PM(S/H)	/14	132	315M	467/IM	1467,5	950	229	199	220	220	2762,5	2345	400	1545	100	1030	780	80	(1)	730	22	160	50	475	65	(2)	1291	4	1527	
PM(S/H)	/14	160	315L	467/IM	1467,5	950	229	199	220	220	2762,5	2345	400	1545	100	1030	780	80	(1)	730	22	160	50	475	65	(2)	1291	4	1605	
PM(S/H)	65/15	90	280M	500/HM	1532,5	1015	229	199	220	220	2587,5	2244	350	1544	90	815	695	80	(1)	645	20	140	42	420	65	(2)	1051	4	1189	
PM(S/H)	/15	110	315S	501/IM	1532,5	1015	229	199	220	220	2717,5	2300	400	1500	100	1030	780	80	(1)	730	22	160	50	475	65	(2)	1181	4	1467	
PM(S/H)	/15	132	315M	502/IM	1532,5	1015	229	199	220	220	2827,5	2359	400	1559	100	1030	780	80	(1)	730	22	160	50	475	65	(2)	1291	4	1541	
PM(S/H)	/15	160	315L	503/IM	1532,5	1015	229	199	220	220	2827,5	2410	400	1610	100	1030	780	80	(1)	730	22	160	50	475	65	(2)	1291	4	1621	
PM(S/H)	/15	200	315L	504/IE4/LQ	1532,5	1015	229	199	220	220	2917,5	2500	400	1700	198	1030	780	80	(1)	730	22	160	50	475	65	(2)	1381	4	1754	
PM(S/H)	65/16	90	280M	511/HM	1597,5	1080	229	199	220	220	2652,5	2309	400	1509	90	815	695	80	(1)	645	20	140	42	420	65	(2)	1051	4	1205	
PM(S/H)	/16	110	315S	512/IM	1597,5	1080	229	199	220	220	2782,5	2365	400	1565	100	1030	780	80	(1)	730	22	160	50	475	65	(2)	1181	4	1483	
PM(S/H)	/16	132	315M	513/IM	1597,5	1080	229	199	220	220	2892,5	2424	400	1624	100	1030	780	80	(1)	730	22	160	50	475	65	(2)	1291	4	1558	
PM(S/H)	/16	160	315L	514/IM	1597,5	1080	229	199	220	220	2892,5	2475	400	1675	100	1030	780	80	(1)	730	22	160	50	475	65	(2)	1291	4	1638	
PM(S/H)	/16	200	315L	515/IE4/LQ	1597,5	1080	229	199	220	220	2982,5	2565	450	1665	198	1030	780	80	(1)	730	22	160	50	475	65	(2)	1381	4	1770	

BGAM = Base and coupling
 * = Indicatives values according to the type of motor installed.
 ○ Motor in IE4 efficiency class according to EU REGULATION 2019/1781. Available in other efficiency classes for non-EU markets.

BGAM = Socle et accouplement
 * = Valeurs indicatives en fonction de la marque du moteur utilisé.
 ○ Moteur en classe de rendement IE4 conformément au RÈGLEMENT UE2019/1781. Disponibilitè en différentes classes de rendement pour les marchés hors UE.

BGAM = Base giunto e coprugiunto
 * = Valori indicativi in funzione della marca di motore utilizzato.
 ○ Motore in classe di efficienza IE4 in conformità al REGOLAMENTO UE2019/1781. Disponibili in altre classi di efficienza per mercati extra UE.

- (1) PM=25 bar PMS=25 bar PMH=40 bar
- (2) PM=40 bar PMS=63 bar PMH=100 bar

- (1) PM=25 bar PMS=25 bar PMH=40 bar
- (2) PM=40 bar PMS=63 bar PMH=100 bar

- (1) PM=25 bar PMS=25 bar PMH=40 bar
- (2) PM=40 bar PMS=63 bar PMH=100 bar

Selection - dimensions and weights for base mounted electric pumps
 Sélection - dimensions et poids des électropompes sur socle
 Selezione - dimensioni e pesi elettropompe su base

COUPLINGS WITH STANDARDIZED ENCLOSED ELECTRIC MOTORS
 ACCOUPLEMENTS AVEC MOTEURS ÉLECTRIQUES FERMÉS NORMALISÉS
 ACCOPIAMENTI CON MOTORI ELETTRICI CHIUSI NORMALIZZATI

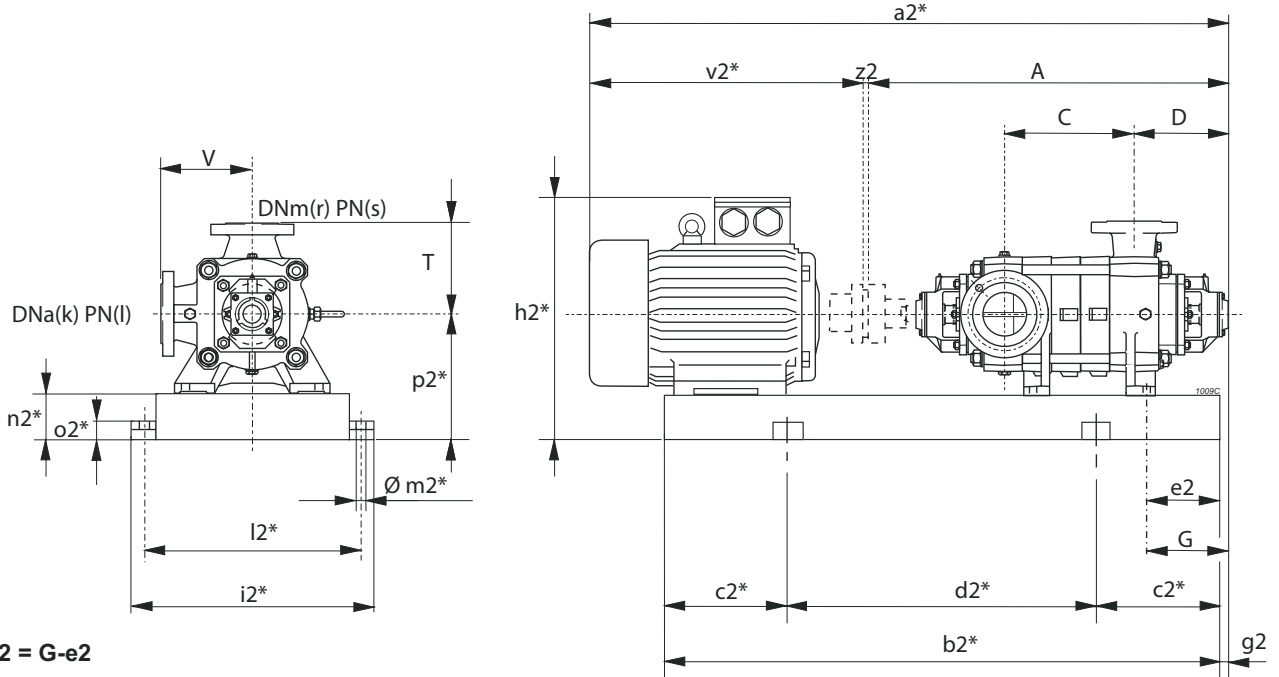

* Valori indicativi in funzione della marca di motore utilizzato
 Indicatives values according to the type of motor installed

Pump Pompe Pompa	Motor Moteur Motore	BGAM	A	C	D	G	T	V	a2*	b2*	c2*	d2*	e2	h2*	i2*	k	l	l2*	m2*	n2*	o2*	p2*	r	s	v2*	z2	Weight Poids Peso		
Series Série Serie	Type Type Tipo	[kW] Size Taille Grand.	Type Type Tipo	[mm]																							[kg]		
PM(S)	65/2	1,1	90S	197/CL	687,5	170	229	199	220	220	1046,5	774	150	474	40	418	500	80	(1)	450	20	100	42	280	65	(2)	355	4	170
PM(S)	/2	1,5	90L	198/CL	687,5	170	229	199	220	220	1076,5	799	150	499	40	418	500	80	(1)	450	20	100	42	280	65	(2)	385	4	175
PM(S)	/2	2,2	100L	199/CL	687,5	170	229	199	220	220	1096,5	834	150	534	40	430	500	80	(1)	450	20	100	42	280	65	(2)	405	4	188
PM(S)	/2	3	100L	199/CL	687,5	170	229	199	220	220	1096,5	834	150	534	40	430	500	80	(1)	450	20	100	42	280	65	(2)	405	4	192
PM(S)	65/3	2,2	100L	201/CL	752,5	235	229	199	220	220	1161,5	899	150	599	40	430	500	80	(1)	450	20	100	42	280	65	(2)	405	4	203
PM(S)	/3	3	100L	201/CL	752,5	235	229	199	220	220	1161,5	899	150	599	40	430	500	80	(1)	450	20	100	42	280	65	(2)	405	4	207
PM(S)	/3	4	112M	202/CL	752,5	235	229	199	220	220	1196,5	906	150	606	40	452	500	80	(1)	450	20	100	42	280	65	(2)	440	4	209
PM(S)	/3	5,5	132S	203/DL	752,5	235	229	199	220	220	1211,5	967	150	667	40	472	500	80	(1)	450	20	100	42	280	65	(2)	455	4	219
PM(S)	65/4	2,2	100L	204/CL	817,5	300	229	199	220	220	1226,5	964	150	664	40	430	500	80	(1)	450	20	100	42	280	65	(2)	405	4	219
PM(S)	/4	3	100L	204/CL	817,5	300	229	199	220	220	1226,5	964	150	664	40	430	500	80	(1)	450	20	100	42	280	65	(2)	405	4	223
PM(S)	/4	4	112M	205/CL	817,5	300	229	199	220	220	1261,5	971	150	671	40	452	500	80	(1)	450	20	100	42	280	65	(2)	440	4	224
PM(S)	/4	5,5	132S	206/DL	817,5	300	229	199	220	220	1276,5	1032	150	732	40	472	500	80	(1)	450	20	100	42	280	65	(2)	455	4	234
PM(S)	/4	7,5	132M	207/DL	817,5	300	229	199	220	220	1311,5	1070	200	670	40	472	500	80	(1)	450	20	100	42	280	65	(2)	490	4	243
PM(S)	65/5	3	100L	222/CL	882,5	365	229	199	220	220	1291,5	1029	150	729	40	430	500	80	(1)	450	20	100	42	280	65	(2)	405	4	238
PM(S)	/5	4	112M	223/CL	882,5	365	229	199	220	220	1326,5	1036	150	736	40	452	500	80	(1)	450	20	100	42	280	65	(2)	440	4	240
PM(S)	/5	5,5	132S	224/DL	882,5	365	229	199	220	220	1341,5	1097	200	697	40	472	500	80	(1)	450	20	100	42	280	65	(2)	455	4	249
PM(S)	/5	7,5	132M	225/DL	882,5	365	229	199	220	220	1376,5	1135	200	735	40	472	500	80	(1)	450	20	100	42	280	65	(2)	490	4	258
PM(S/H)	65/6	4	112M	226/CL	947,5	430	229	199	220	220	1391,5	1101	200	701	40	452	500	80	(1)	450	20	100	42	280	65	(2)	440	4	255
PM(S/H)	/6	5,5	132S	227/DL	947,5	430	229	199	220	220	1406,5	1162	200	762	40	472	500	80	(1)	450	20	100	42	280	65	(2)	455	4	265
PM(S/H)	/6	7,5	132M	228/DL	947,5	430	229	199	220	220	1441,5	1200	200	800	40	472	500	80	(1)	450	20	100	42	280	65	(2)	490	4	273
PM(S/H)	/6	11	160M	953/EM	947,5	430	229	199	220	220	1578,5	1286	200	886	40	531	500	80	(1)	450	20	100	42	280	65	(2)	627	4	360
PM(S/H)	65/7	4	112M	229/CL	1012,5	495	229	199	220	220	1456,5	1166	200	766	40	452	500	80	(1)	450	20	100	42	280	65	(2)	440	4	270
PM(S/H)	/7	5,5	132S	230/DL	1012,5	495	229	199	220	220	1471,5	1227	200	827	40	472	500	80	(1)	450	20	100	42	280	65	(2)	455	4	280
PM(S/H)	/7	7,5	132M	231/DL	1012,5	495	229	199	220	220	1506,5	1265	200	865	40	472	500	80	(1)	450	20	100	42	280	65	(2)	490	4	289
PM(S/H)	/7	11	160M	232/EM	1012,5	495	229	199	220	220	1643,5	1351	250	851	40	531	500	80	(1)	450	20	100	42	280	65	(2)	627	4	375
PM(S/H)	65/8	5,5	132S	233/DL	1077,5	560	229	199	220	220	1536,5	1292	200	892	40	472	500	80	(1)	450	20	100	42	280	65	(2)	455	4	295
PM(S/H)	/8	7,5	132M	234/DL	1077,5	560	229	199	220	220	1571,5	1330	200	930	40	472	500	80	(1)	450	20	100	42	280	65	(2)	490	4	304
PM(S/H)	/8	11	160M	235/EM	1077,5	560	229	199	220	220	1708,5	1416	250	916	40	531	500	80	(1)	450	20	100	42	280	65	(2)	627	4	390
PM(S/H)	/8	15	160L	236/EM	1077,5	560	229	199	220	220	1708,5	1460	250	960	40	531	500	80	(1)	450	20	100	42	280	65	(2)	627	4	403
PM(S/H)	65/9	5,5	132S	237/DL	1142,5	625	229	199	220	220	1601,5	1357	250	857	40	472	500	80	(1)	450	20	100	42	280	65	(2)	455	4	311
PM(S/H)	/9	7,5	132M	238/DL	1142,5	625	229	199	220	220	1636,5	1395	250	895	40	472	500	80	(1)	450	20	100	42	280	65	(2)	490	4	320

BGAM = Base and coupling
 * = Indicatives values according to the type of motor installed.
 (1) PM=25 bar PMS=25 bar PMH=40 bar
 (2) PM=40 bar PMS=63 bar PMH=100 bar

BGAM = Socle et accouplement
 * = Valeurs indicatives en fonction de la marque du moteur utilisé.
 (1) PM=25 bar PMS=25 bar PMH=40 bar
 (2) PM=40 bar PMS=63 bar PMH=100 bar

BGAM = Base giunto e coprigiunto
 * = Valori indicativi in funzione della marca di motore utilizzato.
 (1) PM=25 bar PMS=25 bar PMH=40 bar
 (2) PM=40 bar PMS=63 bar PMH=100 bar

Selection - dimensions and weights for base mounted electric pumps
 Sélection - dimensions et poids des électropompes sur socle
 Selezione - dimensioni e pesi elettropompe su base

COUPLINGS WITH STANDARDIZED ENCLOSED ELECTRIC MOTORS
 ACCOUPLEMENTS AVEC MOTEURS ÉLECTRIQUES FERMÉS NORMALISÉS
 ACCOPPIAMENTI CON MOTORI ELETTRICI CHIUSI NORMALIZZATI

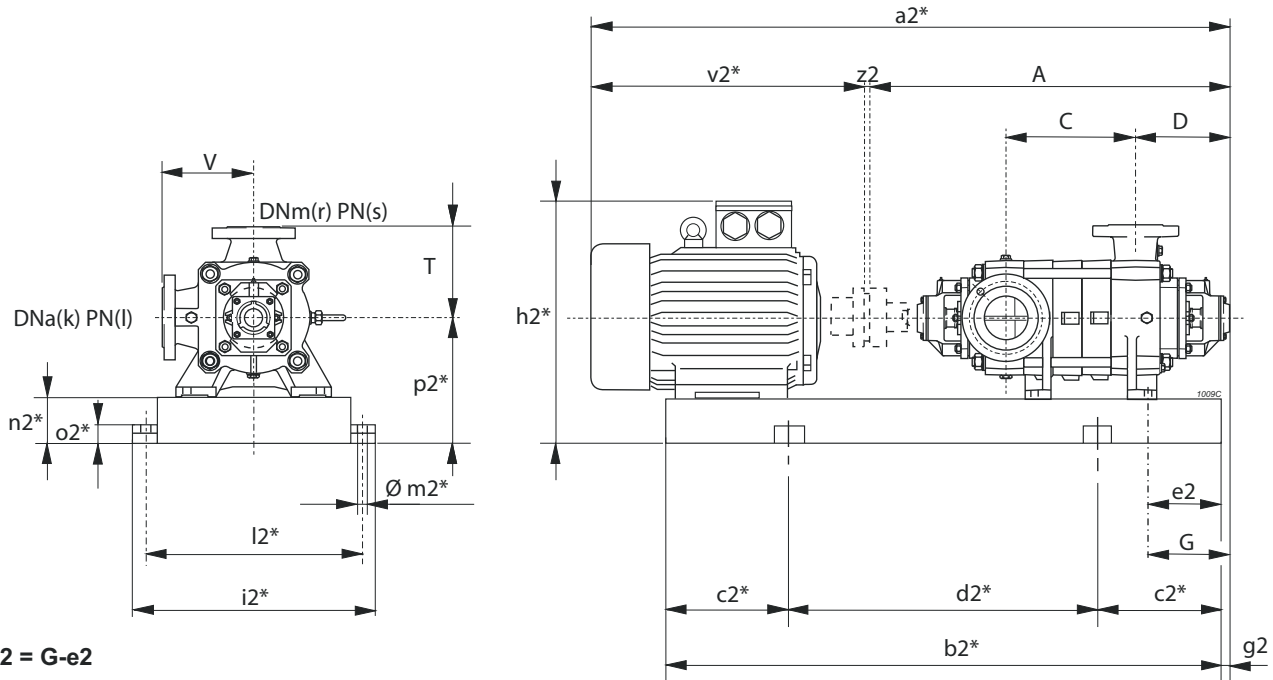

$g2 = G - e2$

* Valori indicativi in funzione della marca di motore utilizzato
 Indicatives values according to the type of motor installed

Pump Pompe Pompa	Motor Moteur Motore	BGAM	A	C	D	G	T	V	a2*	b2*	c2*	d2*	e2	h2*	i2*	k	l	l2*	m2*	n2*	o2*	p2*	r	s	v2*	z2	Weight Poids Peso		
Series Série Serie	Type Type Tipo	[kW]	Size Taille Grand.	Type Type Tipo	[mm]																				[kg]				
PM(S/H)	/9	11	160M	239/EM	1142,5	625	229	199	220	220	1773,5	1481	250	981	40	531	500	80	(1)	450	20	100	42	280	65	(2)	627	4	406
PM(S/H)	/9	15	160L	240/EM	1142,5	625	229	199	220	220	1773,5	1525	250	1025	40	531	500	80	(1)	450	20	100	42	280	65	(2)	627	4	419
PM(S/H)	65/10	5,5	132S	241/DL	1207,5	690	229	199	220	220	1666,5	1422	250	922	40	472	500	80	(1)	450	20	100	42	280	65	(2)	455	4	326
PM(S/H)	/10	7,5	132M	242/DL	1207,5	690	229	199	220	220	1701,5	1460	250	960	40	472	500	80	(1)	450	20	100	42	280	65	(2)	490	4	335
PM(S/H)	/10	11	160M	243/EM	1207,5	690	229	199	220	220	1838,5	1546	250	1046	40	531	500	80	(1)	450	20	100	42	280	65	(2)	627	4	421
PM(S/H)	/10	15	160L	244/EM	1207,5	690	229	199	220	220	1838,5	1590	250	1090	40	531	500	80	(1)	450	20	100	42	280	65	(2)	627	4	434
PM(S/H)	65/11	7,5	132M	284/DL	1272,5	755	229	199	220	220	1766,5	1525	250	1025	40	472	500	80	(1)	450	20	100	42	280	65	(2)	490	4	350
PM(S/H)	/11	11	160M	285/EM	1272,5	755	229	199	220	220	1903,5	1611	250	1111	40	531	500	80	(1)	450	20	100	42	280	65	(2)	627	4	437
PM(S/H)	/11	15	160L	286/EM	1272,5	755	229	199	220	220	1903,5	1655	300	1055	40	531	500	80	(1)	450	20	100	42	280	65	(2)	627	4	449
PM(S/H)	/11	18,5	180M	287/FM	1272,5	755	229	199	220	220	1941,5	1665	300	1065	40	550	500	80	(1)	450	20	100	42	280	65	(2)	665	4	521
PM(S/H)	65/12	7,5	132M	288/DL	1337,5	820	229	199	220	220	1831,5	1590	250	1090	40	472	500	80	(1)	450	20	100	42	280	65	(2)	490	4	366
PM(S/H)	/12	11	160M	289/EM	1337,5	820	229	199	220	220	1968,5	1676	300	1076	40	531	500	80	(1)	450	20	100	42	280	65	(2)	627	4	452
PM(S/H)	/12	15	160L	290/EM	1337,5	820	229	199	220	220	1968,5	1720	300	1120	40	531	500	80	(1)	450	20	100	42	280	65	(2)	627	4	465
PM(S/H)	/12	18,5	180M	291/FM	1337,5	820	229	199	220	220	2006,5	1730	300	1130	40	550	500	80	(1)	450	20	100	42	280	65	(2)	665	4	535
PM(S/H)	65/13	7,5	132M	292/DL	1402,5	885	229	199	220	220	1896,5	1655	300	1055	40	472	500	80	(1)	450	20	100	42	280	65	(2)	490	4	381
PM(S/H)	/13	11	160M	293/EM	1402,5	885	229	199	220	220	2033,5	1741	300	1141	40	531	500	80	(1)	450	20	100	42	280	65	(2)	627	4	467
PM(S/H)	/13	15	160L	294/EM	1402,5	885	229	199	220	220	2033,5	1785	300	1185	40	531	500	80	(1)	450	20	100	42	280	65	(2)	627	4	480
PM(S/H)	/13	18,5	180M	295/FM	1402,5	885	229	199	220	220	2071,5	1795	300	1195	40	550	500	80	(1)	450	20	100	42	280	65	(2)	665	4	516
PM(S/H)	65/14	11	160M	297/EM	1467,5	950	229	199	220	220	2098,5	1806	300	1206	40	531	500	80	(1)	450	20	100	42	280	65	(2)	627	4	483
PM(S/H)	/14	15	160L	298/EM	1467,5	950	229	199	220	220	2098,5	1850	300	1250	40	531	500	80	(1)	450	20	100	42	280	65	(2)	627	4	496
PM(S/H)	/14	18,5	180M	299/FM	1467,5	950	229	199	220	220	2136,5	1860	300	1260	40	550	500	80	(1)	450	20	100	42	280	65	(2)	665	4	531
PM(S/H)	/14	22	180L	300/FM	1467,5	950	229	199	220	220	2176,5	1898	300	1298	40	550	500	80	(1)	450	20	100	42	280	65	(2)	705	4	552
PM(S/H)	65/15	11	160M	505/EM	1532,5	1015	229	199	220	220	2163,5	1871	300	1271	40	531	500	80	(1)	450	20	100	42	280	65	(2)	627	4	498
PM(S/H)	/15	15	160L	506/EM	1532,5	1015	229	199	220	220	2163,5	1915	300	1315	40	531	500	80	(1)	450	20	100	42	280	65	(2)	627	4	511
PM(S/H)	/15	18,5	180M	507/FM	1532,5	1015	229	199	220	220	2201,5	1925	300	1325	40	550	500	80	(1)	450	20	100	42	280	65	(2)	665	4	547
PM(S/H)	/15	22	180L	508/FM	1532,5	1015	229	199	220	220	2241,5	1963	350	1263	40	550	500	80	(1)	450	20	100	42	280	65	(2)	705	4	568
PM(S/H)	65/16	15	160L	516/EM	1597,5	1080	229	199	220	220	2228,5	1980	350	1280	40	531	500	80	(1)	450	20	100	42	280	65	(2)	627	4	526
PM(S/H)	/16	18,5	180M	517/EM	1597,5	1080	229	199	220	220	2266,5	1990	350	1290	40	550	500	80	(1)	450	20	100	42	280	65	(2)	665	4	561
PM(S/H)	/16	22	180L	518/FM	1597,5	1080	229	199	220	220	2306,5	2028	350	1328	40	550	500	80	(1)	450	20	100	42	280	65	(2)	705	4	583

BGAM = Base and coupling

* = Indicatives values according to the type of motor installed.

(1) PM=25 bar PMS=25 bar PMH=40 bar

(2) PM=40 bar PMS=63 bar PMH=100 bar

BGAM = Socle et accouplement

* = Valeurs indicatives en fonction de la marque du moteur utilisé.

(1) PM=25 bar PMS=25 bar PMH=40 bar

(2) PM=40 bar PMS=63 bar PMH=100 bar

BGAM = Base giunto e coprigiunto

* = Valori indicativi in funzione della marca di motore utilizzato.

(1) PM=25 bar PMS=25 bar PMH=40 bar

(2) PM=40 bar PMS=63 bar PMH=100 bar