

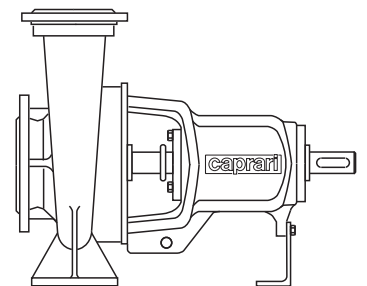

NORM SINGLE-STAGE  
PUMPS -EN733 (DIN 24255)  
*POMPES MONOCELLULAIRES  
NORMALISEES - EN733 (DIN 24255)*  
**POMPE MONOGIRANTI  
NORMALIZZATE - EN733  
(DIN 24255)**

**NC**



**caprari**

pumping power

ISO 9001  
ISO 14001  
ISO 45001  
BUREAU VERITAS  
Certification



	Page - Page - Pagina
• Technical data <i>Données techniques</i> <b>Dati tecnici</b>	3
• Pump coding <i>Identification du sigle</i> <b>Esemplificazione sigla</b>	4
• Performance ranges <i>Champs de performances</i> <b>Campi di prestazione</b>	5
• Performance ranges - Operating limits <i>Champs de performances - Limites de fonctionnement</i> <b>Campi di prestazione - Limiti di funzionamento</b>	6
• Pump construction and materials <i>Construction de la pompe et matériels</i> <b>Costruzione pompa e materiali</b>	7
• Technical data standardized enclosed electric motors <i>Données techniques moteurs électriques fermés</i> <b>Dati tecnici motore elettrico chiuso normalizzato</b>	8
• Performances curves at 950 n [min-1] <i>Caractéristiques de fonctionnement à 950 n [min-1]</i> <b>Caratteristiche di funzionamento a 950 n [min-1]</b>	9
• Performances curves at 1450 n [min-1] <i>Caractéristiques de fonctionnement à 1450 n [min-1]</i> <b>Caratteristiche di funzionamento a 1450 n [min-1]</b>	15
• Performances curves at 2900 n [min-1] <i>Caractéristiques de fonctionnement à 2900 n [min-1]</i> <b>Caratteristiche di funzionamento a 2900 n [min-1]</b>	64
• Overall dimensions and weights <i>Dimensions d'encombrement et poids</i> <b>Dimensioni di ingombro e pesi</b>	91
• Selection - Dimensions and weights for base mounted electric pumps 2P / 50Hz <i>Sélection - Dimensions et poids des électropompes sur socle 2P / 50Hz</i> <b>Selezione - Dimensioni e pesi elettropompe su base 2P / 50Hz</b>	93
• Selection - Dimensions and weights for base mounted electric pumps 4P / 50Hz <i>Sélection - Dimensions et poids des électropompes sur socle 4P / 50Hz</i> <b>Selezione - Dimensioni e pesi elettropompe su base 4P / 50Hz</b>	97
• Selection - Dimensions and weights for base mounted electric pumps 6P / 50Hz <i>Sélection - Dimensions et poids des électropompes sur socle 6P / 50Hz</i> <b>Selezione - Dimensioni e pesi elettropompe su base 6P / 50Hz</b>	103
Flanges (UNI EN 1092-2) - Brides (UNI EN 1092-2) - Flange (UNI EN 1092-2)	104

## GENERAL INFORMATION

Single-stage horizontal shaft pumps with main dimensions and characteristics conforming to EN733 (DIN 24255) standards.

- Pump casing: volute type with flanged delivery port.
- Impeller: high efficiency closed type with balanced axial thrust.  
Available in either cast iron or AISI 316 stainless steel.
- Shaft and supports:  
the AISI 420 stainless steel shaft (fully protected against contact with the pumped water) is guided and supported by two ball bearings housed in the connecting support that are permanently lubricated with high quality grease to guarantee longer life.  
The wide safety margin considered when sizing the support, the shaft and the bearings allows the pump to be coaxially coupled to both electric motors and internal combustion engines.
- Seal:  
the mechanical type, housed in the connecting support and easily replaceable.
- Coupling to the motor  
the NC series pumps can be coupled to IP 55 standard electric motors with B3 motor mounting. The pumps can be coupled to high-efficiency motors. The BACK PULL OUT constructional concept, connection to the motor with a flexible coupling and spacer, available on request, allow the wet end to be disassembled from the rear for inspection purposes and repairs without disconnecting the motor or the pump casing from the piping.
- Direction of rotation:  
clockwise viewed from drive side.
- Port positioning: axial for suction / radial delivery port pointing upwards.

## APPLICATIONS

The NC series standardized pumps have been designed for several applications, such as fire-fighting, industrial water supply, industrial uses, anti-frost protection, irrigation, medium and large heating and air conditioning systems and water supply for both civil and industrial uses.

## LIMITS

- Max. temperature of pumped liquid: +90°C (special versions on request +140°C)
- Min. temperature of pumped liquid: -10°C.
- Max operating time with closed discharge and liquid at 90°C: 30 sec.
- Nominal pressure 10/16 bar (with flanging conforming to UNI 2223 PN16/PN25).
- Maximum content of solids, the same hardness and granulometry of silt: 50 [g/m<sup>3</sup>]
- The pumps can operate with all fluids chemically and mechanically compatible with the pump materials.

Special versions can be supplied on request.

## NOTE:

Upon request the curves NPSH are available until 16 m for 2-pole electric pumps.

## CARACTÉRISTIQUES

Pompes monocellulaires à axe horizontal avec caractéristiques et dimensions principales normalisées EN733 (DIN 24255).

- Corps de pompe : type à volute avec orifice de refoulement à bride.
- Roue : de type fermé à haut rendement, avec équilibrage et la poussée axiale.  
Disponible en fonte ou en acier inoxydable AISI 316
- Arbre et paliers:  
l'arbre en acier inoxydable AISI 420, (totalement protégé du contact avec l'eau pompée) est guidé et soutenu par deux roulements à billes logés dans le palier de liaison à lubrification permanente par de la graisse haute qualité, en garantie d'une très longue durée.  
L'ample marge de sécurité adoptée dans le dimensionnement du palier, de l'arbre et des roulements, permet l'accouplement coaxial tant à des moteurs électriques qu'à combustion interne.
- Garniture:  
de type mécanique logée dans le palier de liaison et facile à remplacer.
- Accouplement au moteur  
les pompes série NC peuvent être accouplées à des moteurs électriques suivant le standard IP 55 dans la forme de construction B3; la pompe peut être accouplée à des moteurs à haut rendement. Le principe de fabrication «BACK PULL OUT» ainsi que l'accouplement au moteur par joint élastique et entretoise d'espaceur sur demande permettent de démonter la partie hydraulique par l'arrière pour les contrôles techniques ou la réparation, sans débrancher le moteur et le corps de la pompe des tuyauteries.
- Sens de rotation :  
horaire vu côté commande.
- Orientation des orifices : aspiration axiale / orifice de refoulement radiale tourné vers le haut.

## APPLICATIONS

Les pompes normalisées série NC ont été conçues pour de nombreux secteurs d'activité : anti-incendie, réseaux industriels de distribution d'eau, anti-gel, irrigation, installations moyennes et grandes de chauffage et de conditionnement, alimentation en eau potable à usage civil et industriel.

## LIMITES D'EMPLOI

- Température max. du liquide pompé : +90°C (des versions spéciales sur demande +140°C)
- Température min. du liquide pompé : -10°C
- Temps max. de fonctionnement à refoulement fermé avec liquide à 90°C: 30 s.
- Pression nominale 10/16 bar (avec brides normalisées UNI 2223 PN16/PN25).
- Contenu maximum des substances solides de la dureté et la granulométrie du limon: 50 [g/m<sup>3</sup>].
- Possibilité de véhiculer de nombreux liquides chimiquement et mécaniquement agressifs, compatibles avec les matériaux constitutifs des pompes.

Des versions spéciales peuvent être fournies sur demande.

## NOTE:

Sur demande sont disponibles les courbes avec NPSH jusqu'à 16m pour les électropompes à 2 pôles.

## CARATTERISTICHE

Pompe monogiranti ad asse orizzontale con caratteristiche e dimensioni principali secondo le norme EN733 (DIN 24255).

- Corpo pompa: del tipo a voluta con bocca premente flangiata.
- Girante: del tipo chiuso ad elevato rendimento, con equilibratura della spinta assiale.  
Disponibile in ghisa o acciaio inox AISI 316.
- Albero e supporti:  
l'albero in acciaio inossidabile AISI 420, (totalmente protetto dal contatto con l'acqua pompata) è guidato e sostenuto da due cuscinetti a sfere alloggiati nel supporto di collegamento e lubrificati a grasso permanente di alta qualità a garanzia di una più lunga durata.  
L'ampio margine di sicurezza tenuto nel dimensionare il supporto, l'albero ed i cuscinetti, consente l'accoppiamento coassiale sia a motori elettrici che endotermici.
- Tenuta:  
di tipo meccanico alloggiata nel supporto di collegamento e facilmente sostituibile.
- Accoppiamento al motore  
le pompe serie NC, possono essere accoppiate a motori elettrici standard IP 55 in forma costruttiva B3; le pompe possono essere accoppiate a motori ad alto rendimento.  
Il concetto costruttivo BACK PULL OUT e l'accoppiamento al motore con giunto elastico e distanziale spaziatore su richiesta consentono lo smontaggio posteriore della parte idraulica per l'ispezione o la riparazione, senza sconnettere il motore ed il corpo pompa dalle tubazioni.
- Senso di rotazione:  
orario visto dal lato comando.
- Orientamento bocche: aspirante assiale / premente radiale rivolta verso l'alto.

## APPLICAZIONI

Le pompe normalizzate serie NC sono state studiate per i settori di utilizzo quali antincendio, acquedottistica, industriale, antibrina, irrigazione, impianti di riscaldamento e condizionamento di medie e grandi dimensioni e approvvigionamento idrico sia ad uso civile che industriale.

## LIMITI D'IMPIEGO

- Temperatura max. liquido sollevato: +90°C. (esecuzione su richiesta +140°C.)
- Temperatura min. liquido sollevato: -10°C.
- Tempo max di funzionamento a bocca chiusa con liquido a 90°C.: 30 sec.
- Pressione nominale 10/16 bar (con flangiature secondo UNI 2223 PN16/PN25).
- Contenuto massimo di sostanze solide della durezza e granulometria del limo: 50 [g/m<sup>3</sup>].
- Possibilità di veicolamento di tutti quei liquidi chimicamente e meccanicamente compatibili con i materiali costruttivi delle pompe.

Su richiesta possono essere fornite esecuzioni speciali.

## NOTA:

Su richiesta sono disponibili curve con NPSH a 16m per le elettropompe a 2 poli.

PUMP CODING  
IDENTIFICATION DU SIGLE  
ESEMPLIFICAZIONE SIGLA

Code - Désignation - Sigla

NC50-315/. - NCF50-315/. - NCH50-315/. - NCHF50-315/.

Series NC (with Cast Iron impeller) -  
Séries NC (Avec roue en fonte grise)  
Serie NC (con girante in ghisa)

NC

Series NCF (with AISI 316 stainless steel impeller) -  
Séries NCF (Avec roue en acier inox AISI 316)  
Serie NCF (con girante in acciaio inox AISI 316)

NCF

50

-

315

/.

Series NCH (High pressure) -  
Séries NCH (Haute pression) - Serie NCH (Alta pressione)

NCH

Series NCHF (High pressure) (with AISI 316 stainless steel impeller) -  
Séries NCHF (Haute pression) (Avec roue en acier inox AISI 316) -  
Serie NCHF (Alta pressione) (con girante in acciaio inox AISI 316)

NCHF

Nominal diameter (mm) of delivery port -  
Diamètre nominal (mm) orifice de refoulement - Diametro nominale (mm) bocca premente

Impeller diameter (mm) - Diamètre roue (mm) - Diametro girante (mm)

Executions on demand - Executions sur demande - Esecuzioni a richiesta

MECHANICAL SEAL

ÉTANCHÉITÉ MÉCANIQUE

TENUTA MECCANICA

Component / Particulier / Particolare				
Type Type Tipo	Ressort Spring Molla	Joints Gaskets Guarnizioni	Static seat Grain fixe Anello fisso	Rotatic seat Grain tournant Anello rotante
Material/ Matériel / Materiale				
Standard	AISI 316	EPDM	SILICON CARBIDE CARBURE DE SILICIUM CARBURO DI SILICIO	SILICON CARBIDE CARBURE DE SILICIUM CARBURO DI SILICIO

**PUMPED LIQUID**

Conforming to : DIN 24960 - ISO 3069.

**TOLERANCES**

Service conditions have been measured with cold water (15°C - 59°F) at 1 bar atmospheric pressure. These tolerances are guaranteed with standard assembly line pumps built according to UNI/ISO 9906 Grade 3B.

Catalogue data are for liquids with a density of 1 kg/dm<sup>3</sup>, and kinematic viscosity not exceeding 1 mm<sup>2</sup>/s. If requested the pump can be tested according to UNI/ISO 9906 Grade 2B standards.

**LIQUIDE À POMPER**

Normalisé : DIN 24960 - ISO 3069.

**TOLERANCES**

Les caractéristiques de fonctionnement ont été mesurées avec de l'eau froide (15°C.) à la pression atmosphérique (1bar). Comme il s'agit de pompes construites en séries, elles sont garanties selon les normes UNI/ISO 9906 Niveau 3B.

Les données du catalogue se réfèrent à des liquides ayant une densité de 1 kg/dm<sup>3</sup> et une viscosité cinématique qui ne dépasse pas 1 mm<sup>2</sup>/s. Sur demande, peuvent être testées selon normes UNI/ISO 9906 Niveau 2B.

**LIQUIDO DA SOLLEVARE**

Secondo le norme : DIN 24960 - ISO 3069.

**TOLLERANZE**

Le caratteristiche di funzionamento sono state rilevate con acqua fredda (15°C) alla pressione atmosferica (1bar) e vengono garantite, trattandosi di pompe costruite in serie, secondo le norme UNI/ISO 9906 grado 3B.

I dati di catalogo si riferiscono a liquidi con densità di 1kg/dm<sup>3</sup> e con viscosità cinematica non superiore a 1mm<sup>2</sup>/s. Su richiesta, possono essere collaudate secondo le norme UNI/ISO 9906 grado 2B.

Performance ranges  
Champs de performance  
Campi di prestazione

Performance curves at 2900 n [min<sup>-1</sup>] / Caractéristiques de fonctionnement à 2900 n [min<sup>-1</sup>] / Caratteristiche di funzionamento a 2900 n [min<sup>-1</sup>]

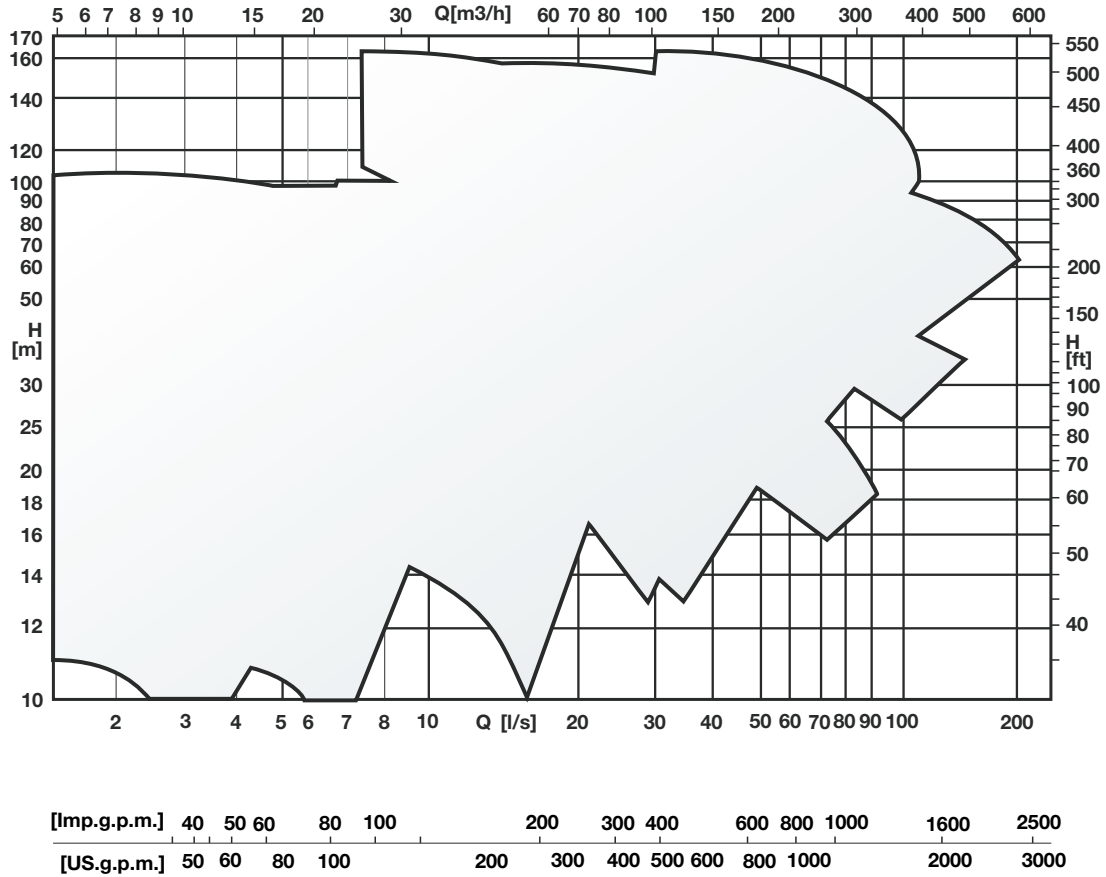

Performance curves at 1450 n [min<sup>-1</sup>] / Caractéristiques de fonctionnement à 1450 n [min<sup>-1</sup>] / Caratteristiche di funzionamento a 1450 n [min<sup>-1</sup>]

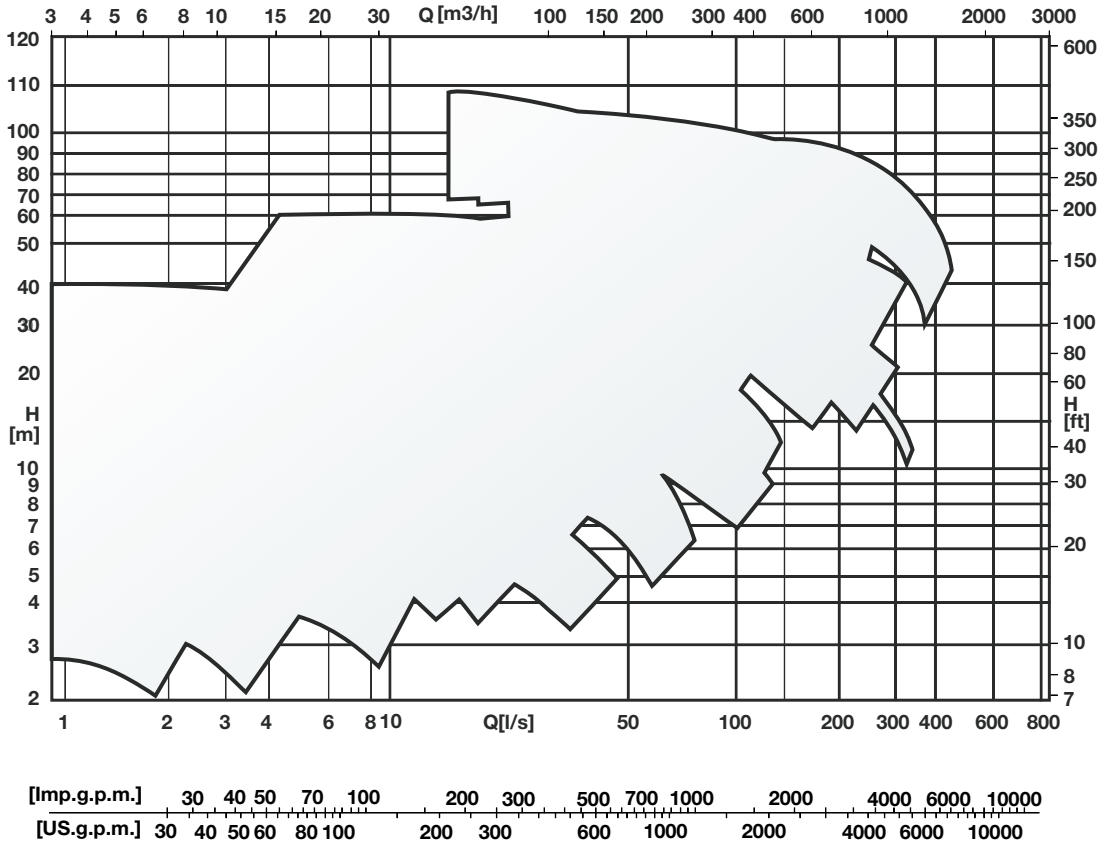

\*Parameters not covered by EN733 (DIN24255): see performance fields / *Tailles non prévues en EN733 (DIN24255): Voir plages de performance* / Grandezze non previste in EN733 (DIN24255): vedi campi di prestazione

Performance ranges - Operating limits  
 Champs de performance - Limites de fonctionnement  
 Campi di prestazione - Limiti di funzionamento

Performance curves at 950 n [min<sup>-1</sup>] / *Caractéristiques de fonctionnement à 950 n [min<sup>-1</sup>]* / *Caratteristiche di funzionamento a 950 n [min<sup>-1</sup>]*

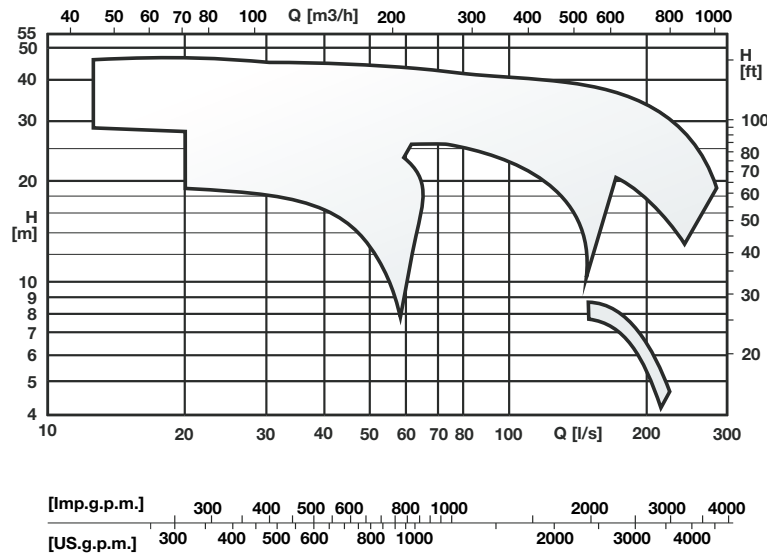

\* Parameters not covered by EN733 (DIN24255): see performance fields / *Tailles non prévues en EN733 (DIN24255): Voir plages de performance / Grandezze non previste in EN733 (DIN24255): vedi campi di prestazione*

OPERATING LIMITS / *LIMITES DE FONCTIONNEMENT* / **LIMITI DI FUNZIONAMENTO**

Maximum speed <i>Vitesse maximum</i> Velocità massima	[min <sup>-1</sup> ]
NC32-125	3500
NCF32-125	
NC32-160	3500
NCF32-160	
NC32-200	3500
NCF32-200	
NC32-250	3500
NCF32-250	
NC40-125	3500
NCF40-125	
NC40-160	3500
NCF40-160	
NC40-200	3500
NCF40-200	
NC40-250	3500
NCF40-250	
NC40-315	1750
NCF40-315	
NC50-125	3500
NCF50-125	
NC50-160	3500
NCF50-160	
NC50-200	3500
NCF50-200	
NC50-250	3500
NCF50-250	
NC50-315	1750
NCF50-315	
NC65-125	3500
NCF65-125	
NC65-160	3500
NCF65-160	
NC65-200	3500
NCF65-200	

Maximum speed <i>Vitesse maximum</i> Velocità massima	[min <sup>-1</sup> ]
NC65-250	3500
NCF65-250	
NC65-315	1750
NCF65-315	
NC80-160	3500
NCF80-160	
NC80-200	3500
NCF80-200	
NC80-250	3500
NCF80-250	
NC80-315	2200
NCF80-315	
NC80-400	1750
NCF80-400	
NC100-160	3500
NCF100-160	
NC100-200	3500
NCF100-200	
NC100-250	3500
NCF100-250	
NC100-315	2200
NCF100-315	
NC100-400	1750
NCF100-400	
NC125-200	3500
NCF125-200	
NC125-250	2200
NCF125-250	
NC125-315	1750
NCF125-315	
NC125-400	1750
NCF125-400	
NC150-200	1750
NCF150-200	

Maximum speed <i>Vitesse maximum</i> Velocità massima	[min <sup>-1</sup> ]
NC150-250	1750
NCF150-250	
NC150-315	1750
NCF150-315	
NC150-400	1750
NCF150-400	
NC200-250	1750
NCF200-250	
NC200-315	1750
NCF200-315	
NC200-400	1750
NCF200-400	
NC250-315	1750
NCF250-315	
NC250-400	1750
NCF250-400	
NCH50-315	2900
NCHF50-315	
NCH65-315	2900
NCHF65-315	
NCH100-315	2900
NCHF100-315	
NCH125-250	2900
NCHF125-250	
NCH125-400	1750
NCHF125-400	
NCH125-500	1450
NCHF125-500	
NCH150-500	1450
NCHF150-500	
NCH200-500	1450
NCHF200-500	
NCH250-250	1750
NCHF250-250	
NCH250-500	1750
NCHF250-500	

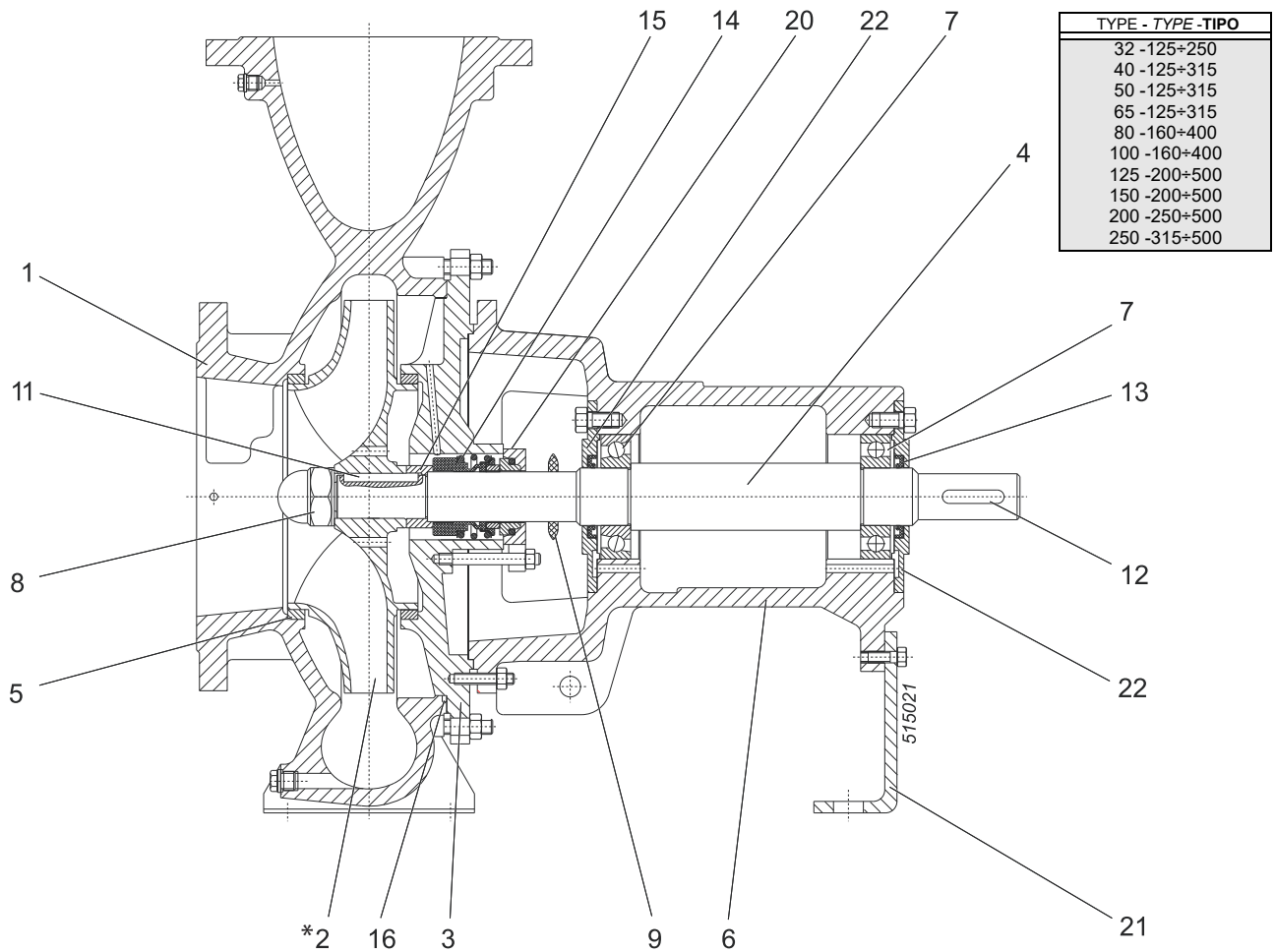

Pos.	Parts	Materials	Nomenclature	Matériaux	Nomenclatura	Materiale
1	Pump casing	Cast iron	Corps de pomp	Fonte grise	Corpo pompa	Ghisa grigia
2*	Impeller	Cast iron	Roue	Fonte grise	Girante	Ghisa grigia
3	Lantern bracket	Cast iron	Lanterne-support	Fonte grise	Supporto di collegamento	Ghisa grigia
4	Shaft	Stainless steel	Arbre	Acier inox	Albero	Acciaio inox
5	Impeller wear ring	Cast iron	Bague d'usure	Fonte grise	Anello sede girante	Ghisa grigia
6	Support	Cast iron	Support	Fonte grise	Supporto	Ghisa grigia
7	Bearing	-	Coussinet	-	Cuscinetto	-
8	Nut	Stainless steel	Ecrou	Acier inox	Dado	Acciaio inox
9	Water retainer ring	Nitrile rubber	Bague défecteur	Caoutchouc nitrile	Anello para-acqua	Gomma nitrilica
11	Feather key	Stainless steel	Languette	Acier inox	Linguetta	Acciaio inox
12	Feather key 2	Steel	Languette 2	Acier	Linguetta 2	Acciaio
13	Seal ring	Nitrile rubber	Bague d'étanchéité	Caoutchouc nitrile	Anello di tenuta	Gomma nitrilica
14	Mechanical seal	Silicon carbide/silicon carbide	Garniture mécanique	Carbure de silicium/ carbure de silicium	Tenuta meccanica	Carburo di silicio/ carburo di silicio
15	Spacer sleeve	Stainless steel	Entretoise	Acier inox	Distanziale	Acciaio inox
16	OR Seal ring	Nitrile rubber	Bague d'étanchéité OR	Caoutchouc nitrile	Anello di tenuta OR	Gomma nitrilica
20	Cover mechanical seal	Cast iron	Couvercle garniture mécanique	Fonte grise	Coperchio tenuta meccanica	Ghisa grigia
21	Duck foot pedestal	Steel	Pied de soutien	Acier	Piede di sostegno	Acciaio
22	Cover bearing	Cast iron	Couvercle palier	Fonte grise	Coperchio cuscinetto	Ghisa grigia

Screws and nuts in stainless steel.

\* In AISI 316 for the NCF./... versions

Vis et écrous en acier inox.

\* En acier inox AISI 316 pour les versions NCF./...

Viti e dadi in acciaio inox

\* In acciaio inox AISI 316 per versioni NCF./...

Technical data standardized enclosed electric motors (Indicatives values according to the type of motor installed)  
 Données techniques moteurs électriques fermés normalisés (Valeurs indicatives en fonction de la marque du moteur utilisé)  
 Dati tecnici motore elettrico chiuso normalizzato (Valori indicativi in funzione della marca di motore utilizzato)

Motor power Puiss. moteur Potenza motore	2 Poles 50 Hz 2 Pôles 50 Hz 2 Poli 50 Hz			4 Poles 50 Hz 4 Pôles 50 Hz 4 Poli 50 Hz			6 Poles 50 Hz 6 Pôles 50 Hz 6 Poli 50 Hz		
	Max. number starts/hour* Nombre maxi. de démarrages/heure* Numero massimo di avviamenti/ora*	Voltage variation Variation de tension Variazione di tensione	Dinamic momentum J Momentum dynamique J Momento dinamico J	Max. number starts/hour* Nombre maxi. de démarrages/heure* Numero massimo di avviamenti/ora*	Voltage variation Variation de tension Variazione di tensione	Dinamic momentum J Momentum dynamique J Momento dinamico J	Max. number starts/hour* Nombre maxi. de démarrages/heure* Numero massimo di avviamenti/ora*	Voltage variation Variation de tension Variazione di tensione	Dinamic momentum J Momentum dynamique J Momento dinamico J
	[kW]	[%]	[kg m <sup>2</sup> ]	[kW]	[%]	[kg m <sup>2</sup> ]	[kW]	[%]	[kg m <sup>2</sup> ]
0,75	3	± 10 (400V)	0,001	3	± 10 (400V)	0,003	3	± 10 (400V)	0,005
1,1	3	± 10 (400V)	0,002	3	± 10 (400V)	0,004	3	± 10 (400V)	0,008
1,5	3	± 10 (400V)	0,002	3	± 10 (400V)	0,005	3	± 10 (400V)	0,013
2,2	3	± 10 (400V)	0,003	3	± 10 (400V)	0,01	3	± 10 (400V)	0,02
3	3	± 10 (400V)	0,005	3	± 10 (400V)	0,013	3	± 10 (400V)	0,037
4	3	± 10 (400V)	0,008	3	± 10 (400V)	0,02	3	± 10 (400V)	0,05
5,5	3	± 10 (400V)	0,014	3	± 10 (400V)	0,035	3	± 10 (400V)	0,065
7,5	3	± 10 (400V)	0,017	3	± 10 (400V)	0,047	3	± 10 (400V)	0,117
11	3	± 10 (400V)	0,051	3	± 10 (400V)	0,107	3	± 10 (400V)	0,177
15	3	± 10 (400V)	0,064	3	± 10 (400V)	0,129	3	± 10 (400V)	0,316
18,5	3	± 10 (400V)	0,076	3	± 10 (400V)	0,19	3	± 10 (400V)	0,468
22	3	± 10 (400V)	0,117	3	± 10 (400V)	0,226	3	± 10 (400V)	0,548
30	3	± 10 (400V)	0,174	3	± 10 (400V)	0,361	3	± 10 (400V)	0,884
37	3	± 10 (400V)	0,205	3	± 10 (400V)	0,63	3	± 10 (400V)	1,197
45	3	± 10 (400V)	0,302	3	± 10 (400V)	0,738	3	± 10 (400V)	2,338
55	3	± 10 (400V)	0,408	3	± 10 (400V)	1,024	3	± 10 (400V)	2,797
75 ○	3	± 10 (400V)	0,677	3	± 10 (400V)	1,4723	3	± 10 (400V)	3,4169
90 ○	3	± 10 (400V)	0,8001	3	± 10 (400V)	1,6775	3	± 10 (400V)	4,1524
110 ○	3	± 10 (400V)	1,5379	3	± 10 (400V)	3,4327	3	± 10 (400V)	5,0761
132 ○	3	± 10 (400V)	1,8654	3	± 10 (400V)	3,9943	3	± 10 (400V)	6,0984
160 ○	3	± 10 (400V)	2,1504	3	± 10 (400V)	4,6494	3	± 10 (400V)	9,4364
200 ○	3	± 10 (400V)	2,3575	3	± 10 (400V)	5,0238	3	± 10 (400V)	9,5737
250	3	± 10 (400V)	3,812	3	± 10 (400V)	9,297	3	± 10 (400V)	13,933
280	3	± 10 (400V)	3,812	3	± 10 (400V)	9,297	-	-	-
315	3	± 10 (400V)	4,463	3	± 10 (400V)	10,286	-	-	-
355	3	± 10 (400V)	4,463	3	± 10 (400V)	11,275	-	-	-
375	3	± 10 (400V)	5,58	3	± 10 (400V)	11,9	-	-	-

Axial drive only, by flexible coupling.

Electric motor operating limits in compliance with IEC 34-1

\* Equally distributed.

"" = Contact the sales network

Entraînement seulement coaxial par accouplement élastique.

Limites de fonctionnement pour le moteur électriques suivant les IEC 34-1

\* Conseillés uniformément repartis.

"" = Contacter le réseau de vente

Azionamento solo coassiale tramite giunto elastico.

Limiti d'utilizzo motore elettrico secondo IEC 34-1.

\* Consigliati equamente ripartiti.

"" = Contattare la rete di vendita

SPECIFICATIONS  
Efficiency class: IE3

CARACTÉRISTIQUE)  
Classe de rendement: IE3

CARATTERISTICHE)  
Classe di efficienza: IE3

○ Motor in IE4 efficiency class according to EU REGULATION 2019/1781. Available in other efficiency classes for non-EU markets.

○ Moteur en classe de rendement IE4 conformément au RÈGLEMENT UE2019/1781. Disponibilités en différentes classes de rendement pour les marchés hors UE.

○ Motore in classe di efficienza IE4 in conformità al REGOLAMENTO UE2019/1781. Disponibili in altre classi di efficienza per mercati extra UE.



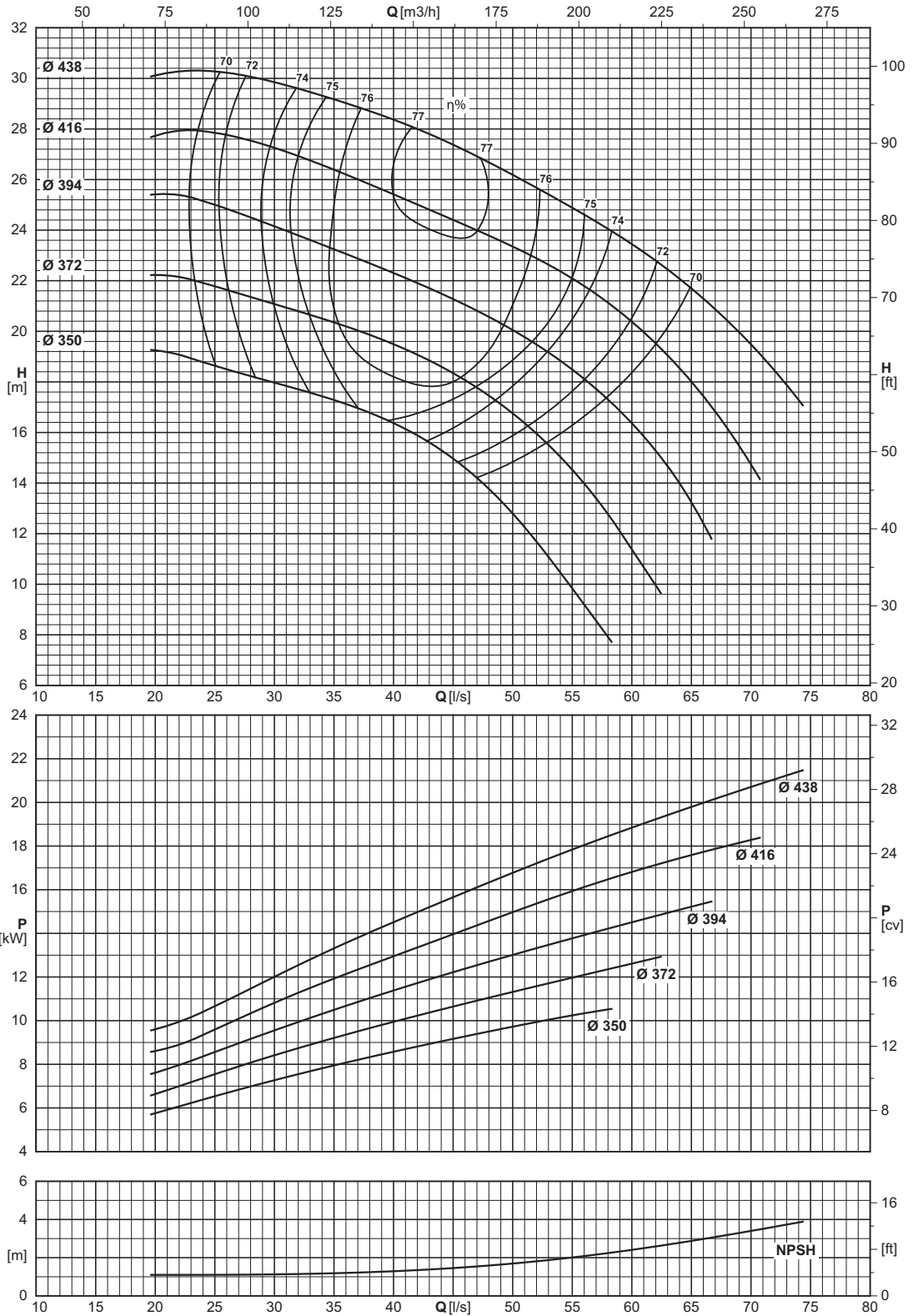

Type Type Tipo	Inlet maximum pressure (*) Pression maximale en aspiration (*) Pressione massima in aspirazione (*)	Dynamic momentum J Momentum dynamique J Momento dinamico J	
		With cast iron impellers Avec roues en fonte Con giranti in ghisa	With AISI 316 impellers Avec roues en AISI 316 Con giranti in AISI 316
		J = 1/4 PD <sup>2</sup>	
	[bar]	[kgm <sup>2</sup> ]	[kgm <sup>2</sup> ]
NCH125-400	6	0	(F) 0

(\*) Value referred to the impeller with maximum diameter.

(\*) Valeur se référant à la roue à ailettes avec le diamètre maximum. (\*) Valore riferito alla girante con diametro massimo.

# NCH 125-500

950 n [min<sup>-1</sup>]



Operating data  
Caracteristiques de fonctionnement  
Caratteristiche di funzionamento

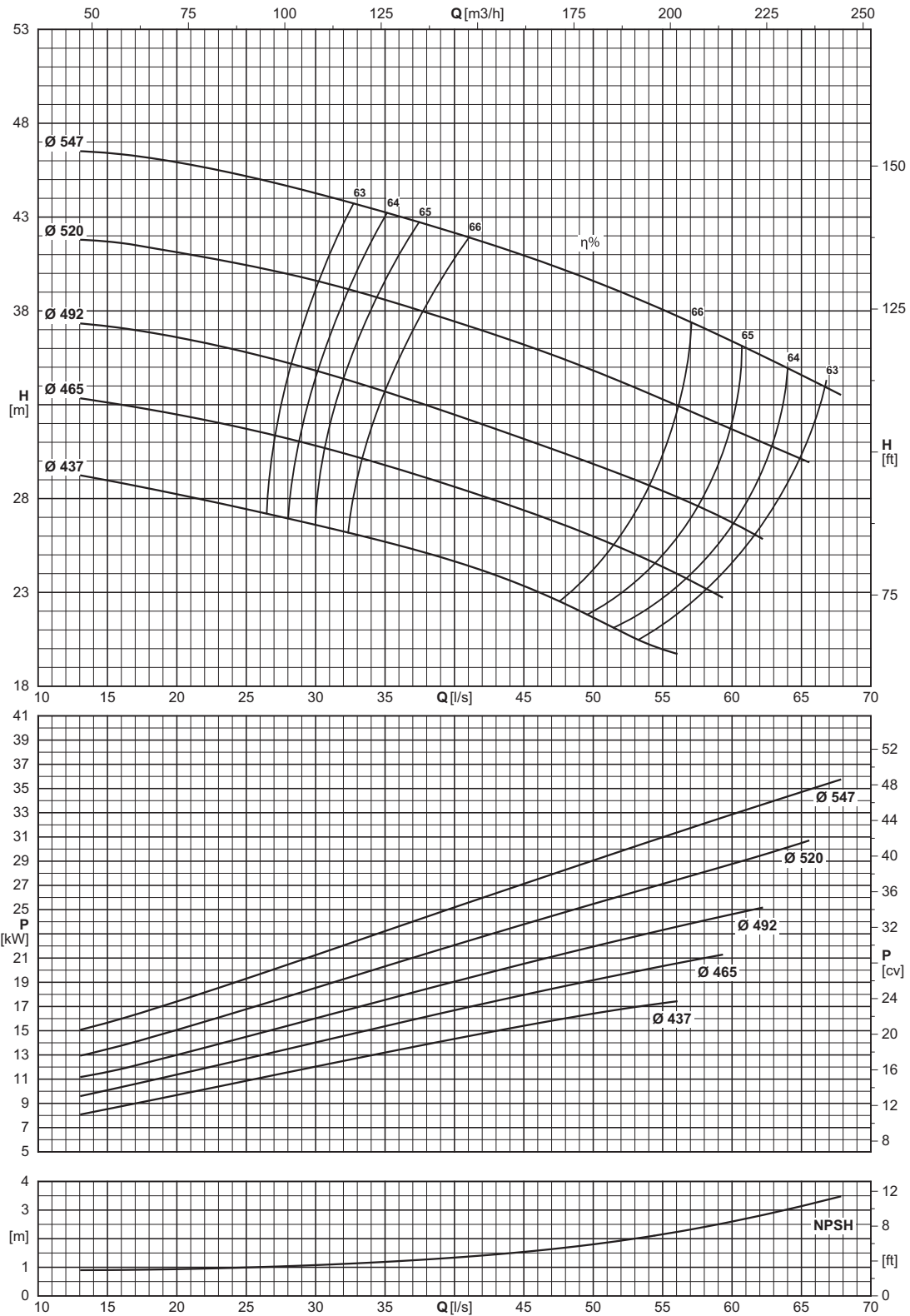

Type Type Tipo	Inlet maximum pressure (*) Pression maximale en aspiration (*) Pressione massima in aspirazione (*)	Dynamic momentum J Momentum dynamique J Momento dinamico J	
		With cast iron impellers Avec roues en fonte Con giranti in ghisa	With AISI 316 impellers Avec roues en AISI 316 Con giranti in AISI 316
		J=1/4PD²	
	[bar]	[kgm²]	(F) 0
NCH125-500	4.5	0	(F) 0

(\*) Value referred to the impeller with maximum diameter.

(\*) Valeur se référant à la roue à ailettes avec le diamètre maximum. (\*) Valore riferito alla girante con diametro massimo.

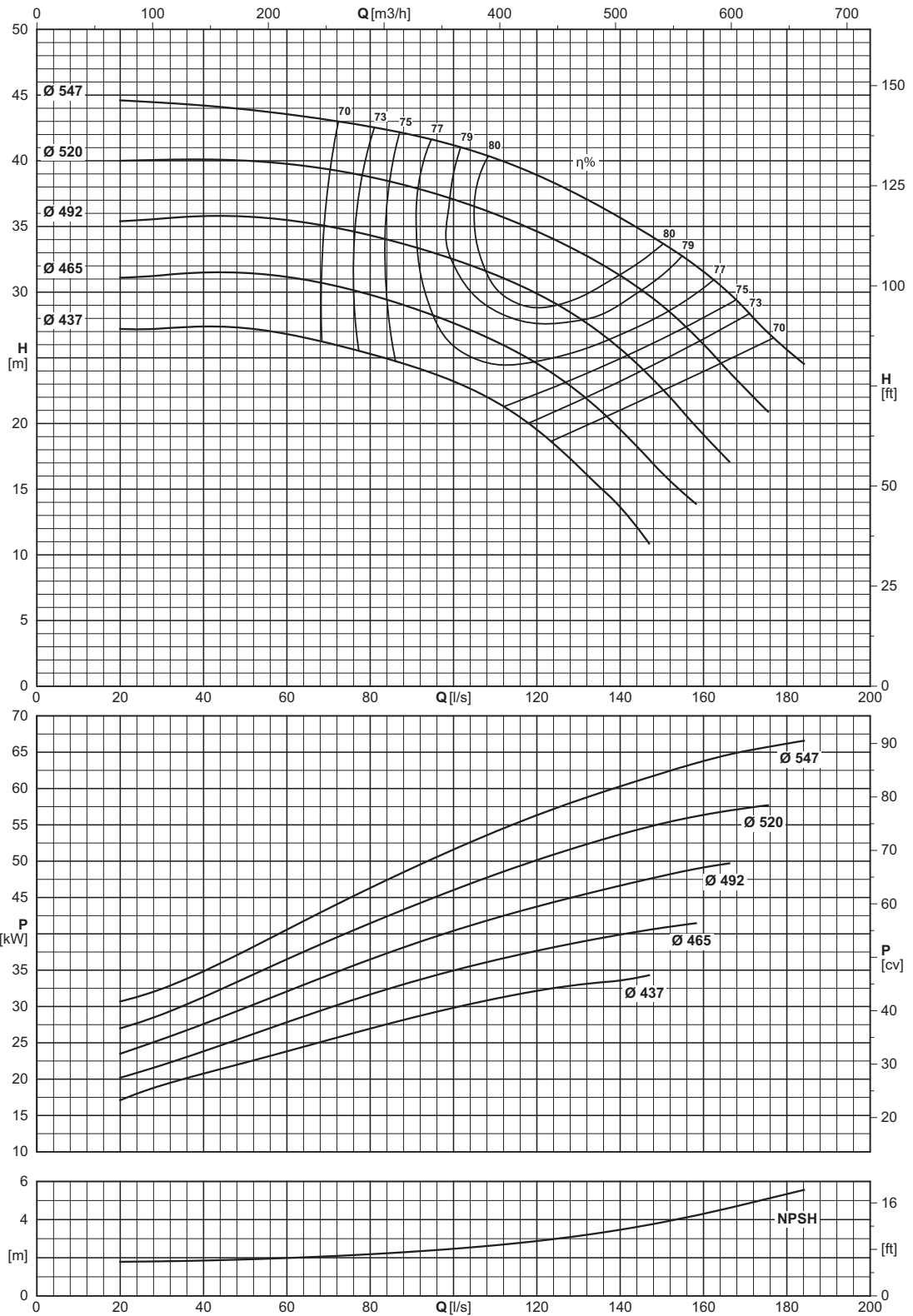

Type Type Tipo	Inlet maximum pressure (*) Pression maximale en aspiration (*) Pressione massima in aspirazione (*)	Dynamic momentum J Momentum dynamique J Momento dinamico J	
		With cast iron impellers Avec roues en fonte Con giranti in ghisa	With AISI 316 impellers Avec roues en AISI 316 Con giranti in AISI 316
		J = 1/4 PD <sup>2</sup>	
	[bar]	[kgm <sup>2</sup> ]	[kgm <sup>2</sup> ]
NCH200-500	4.5	0	(F) 0

(\*) Value referred to the impeller with maximum diameter.

(\*) Valeur se référant à la roue à ailettes avec le diamètre maximum. (\*) Valore riferito alla girante con diametro massimo.

# NCH 250-250

950 n [min<sup>-1</sup>]

**caprari**

Operating data  
Caracteristiques de fonctionnement  
Caratteristiche di funzionamento

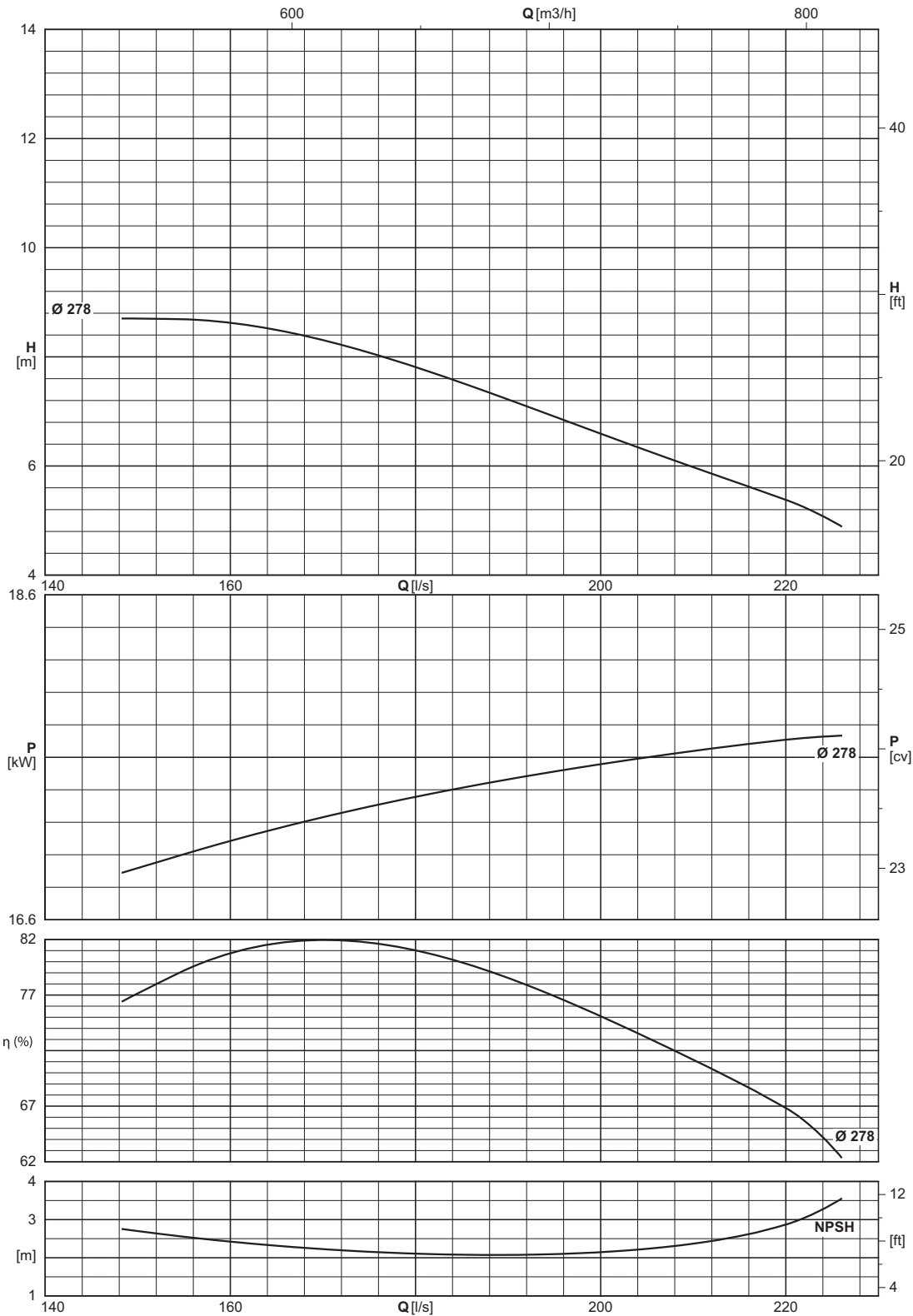

Type Type Tipo	Inlet maximum pressure (*) Pression maximale en aspiration (*) Pressione massima in aspirazione (*)	Dynamic momentum J Momentum dynamique J Momento dinamico J	
		With cast iron impellers Avec roues en fonte Con giranti in ghisa	With AISI 316 impellers Avec roues en AISI 316 Con giranti in AISI 316
		J=1/4PD <sup>2</sup>	
	[bar]	[kgm <sup>2</sup> ]	
NCH250-250	8	0	(F) 0

(\*) Value referred to the impeller with maximum diameter.

(\*) Valeur se référant à la roue à ailettes avec le diamètre maximum. (\*) Valore riferito alla girante con diametro massimo.

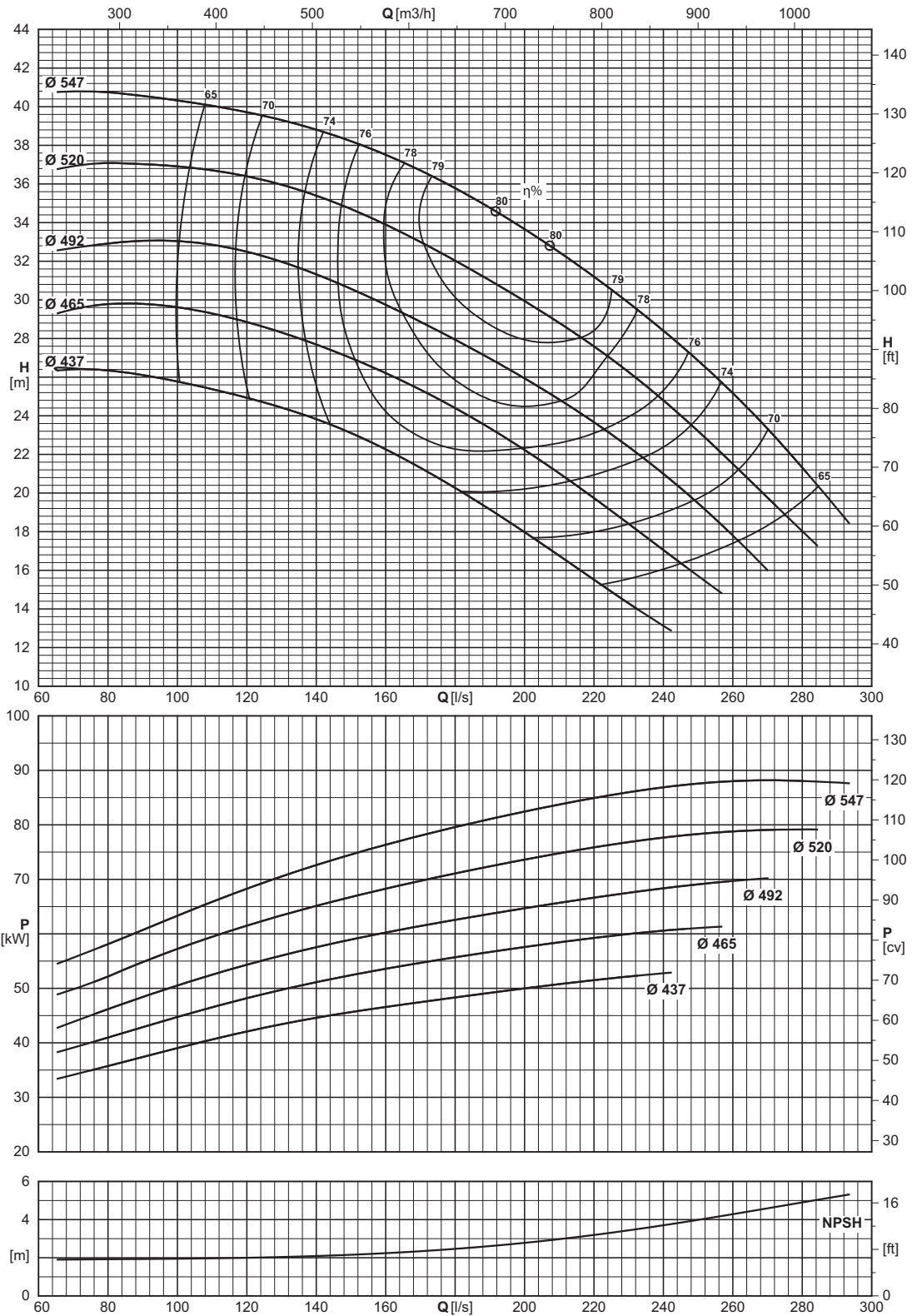

Type Type Tipo	Inlet maximum pressure (*) Pression maximale en aspiration (*) Pressione massima in aspirazione (*)	Dynamic momentum J Momentum dynamique J Momento dinamico J	
		With cast iron impellers Avec roues en fonte Con giranti in ghisa	With AISI 316 impellers Avec roues en AISI 316 Con giranti in AISI 316
		$J = \frac{1}{4}PD^2$	
	[bar]	[kgm <sup>2</sup> ]	
NCH250-500	5	0	(F) 0

(\*) Value referred to the impeller with maximum diameter.

(\*) Valeur se référant à la roue à ailettes avec le diamètre maximum. (\*) Valore riferito alla girante con diametro massimo.

# NCHF 250-500

950 n [min<sup>-1</sup>]



Operating data  
Caracteristiques de fonctionnement  
Caratteristiche di funzionamento

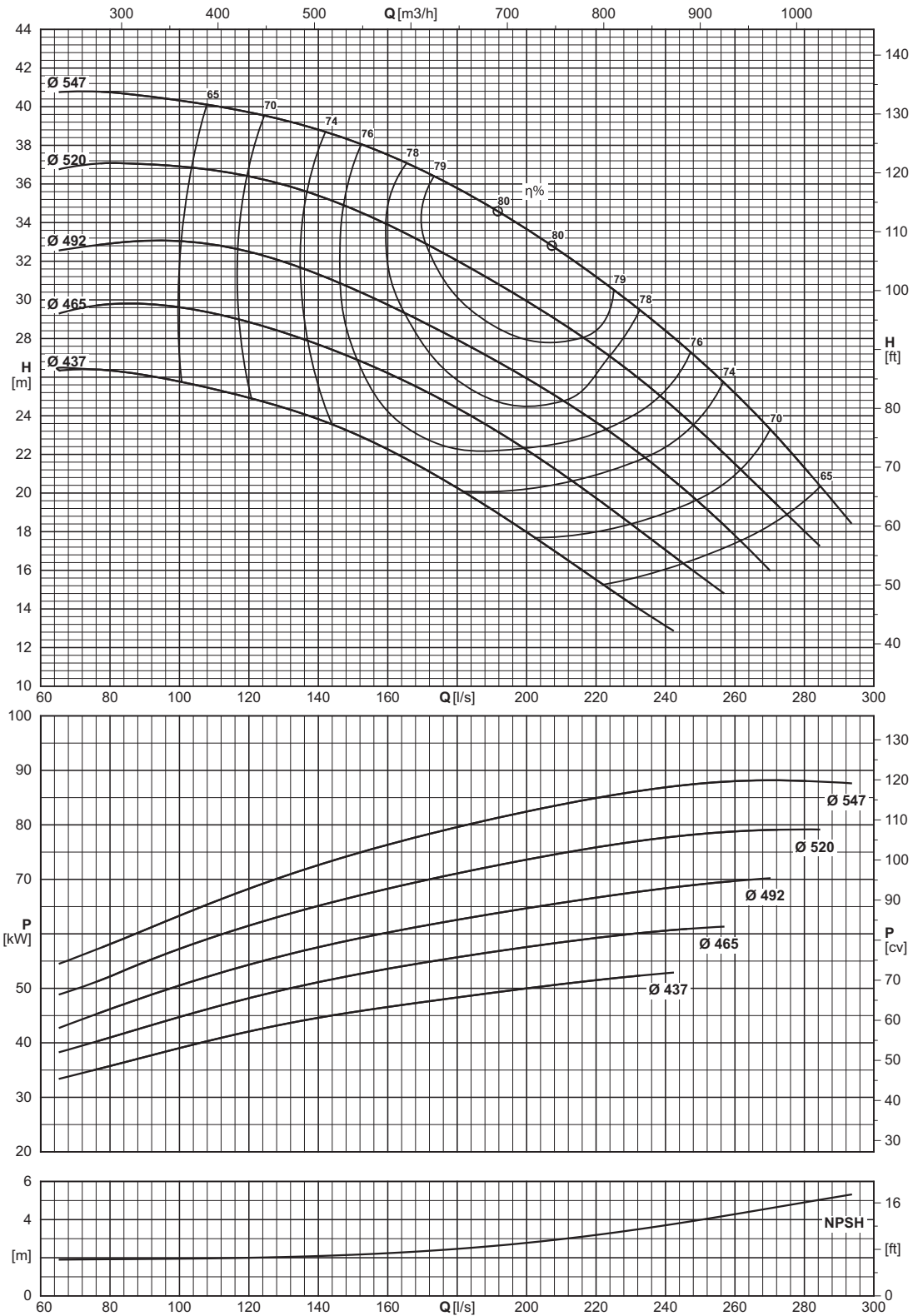

Type Type Tipo	Inlet maximum pressure (*) Pression maximale en aspiration (*) Pressione massima in aspirazione (*)	Dinamic momentum J Momentum dynamique J Momento dinamico J	
		With cast iron impellers Avec roues en fonte Con giranti in ghisa	With AISI 316 impellers Avec roues en AISI 316 Con giranti in AISI 316
		J=1/4PD²	
	[bar]	[kgm²]	[kgm²]
NCHF250-500	5	0	(F) 0

(\*) Value referred to the impeller with maximum diameter.

(\*) Valeur se référant à la roue à ailettes avec le diamètre maximum. (\*) Valore riferito alla girante con diametro massimo.

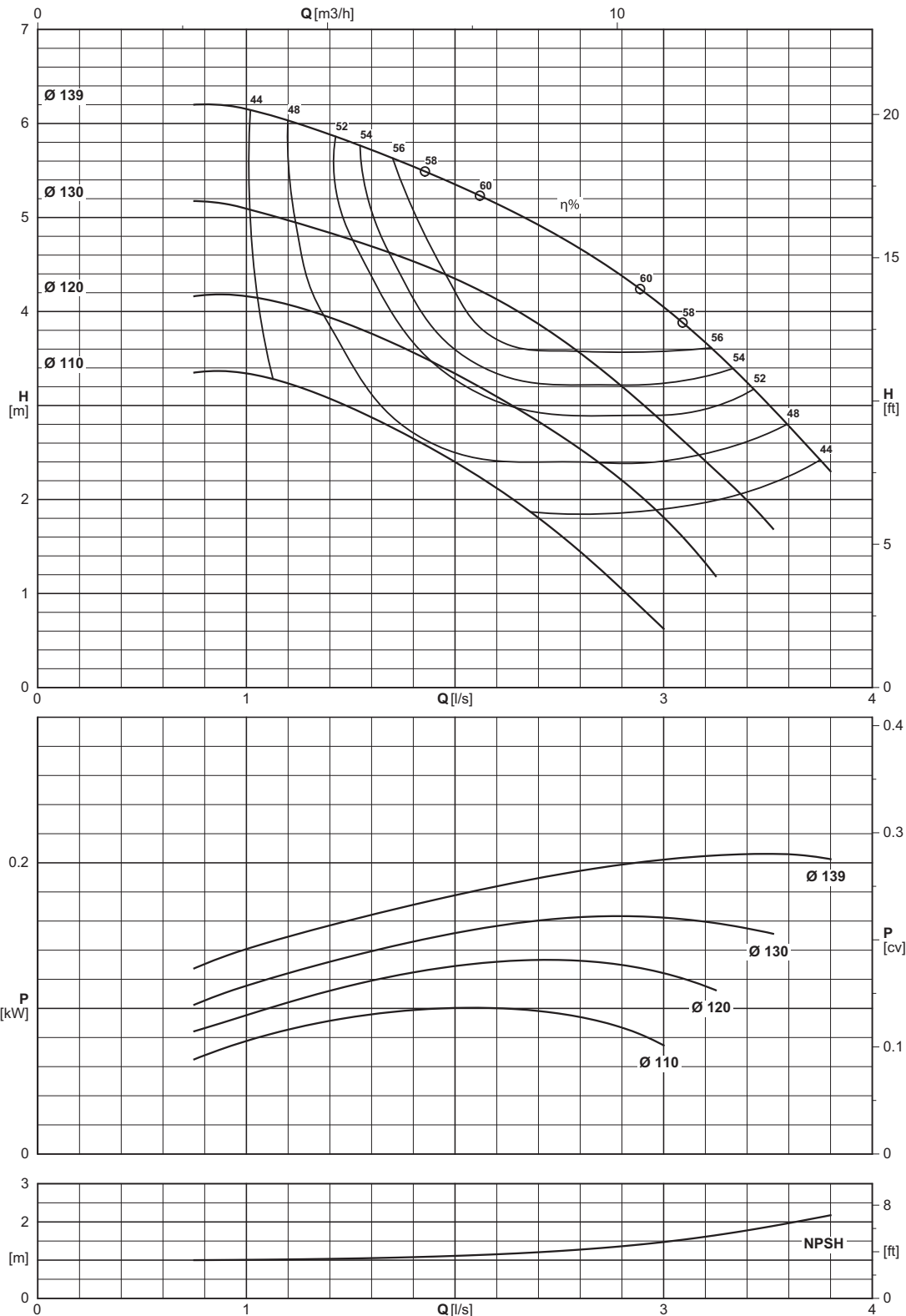

Type Type Tipo	Inlet maximum pressure (*) Pression maximale en aspiration (*) Pressione massima in aspirazione (*)	Dynamic momentum J Momentum dynamique J Momento dinamico J	
		With cast iron impellers Avec roues en fonte Con giranti in ghisa	With AISI 316 impellers Avec roues en AISI 316 Con giranti in AISI 316
		J=1/4PD <sup>2</sup>	
	[bar]	[kgm <sup>2</sup> ]	[kgm <sup>2</sup> ]
NC32-125	8	0,0027116	(F) 0,003099

Construction reference standard EN733 (DIN24255)  
(\*) Value referred to the impeller with maximum diameter.

Norme de référence construction EN733 (DIN24255)  
(\*) Valeur se référant à la roue à ailettes avec le diamètre maximum.

Norma di riferimento costruttivo EN733 (DIN24255)  
(\*) Valore riferito alla girante con diametro massimo.

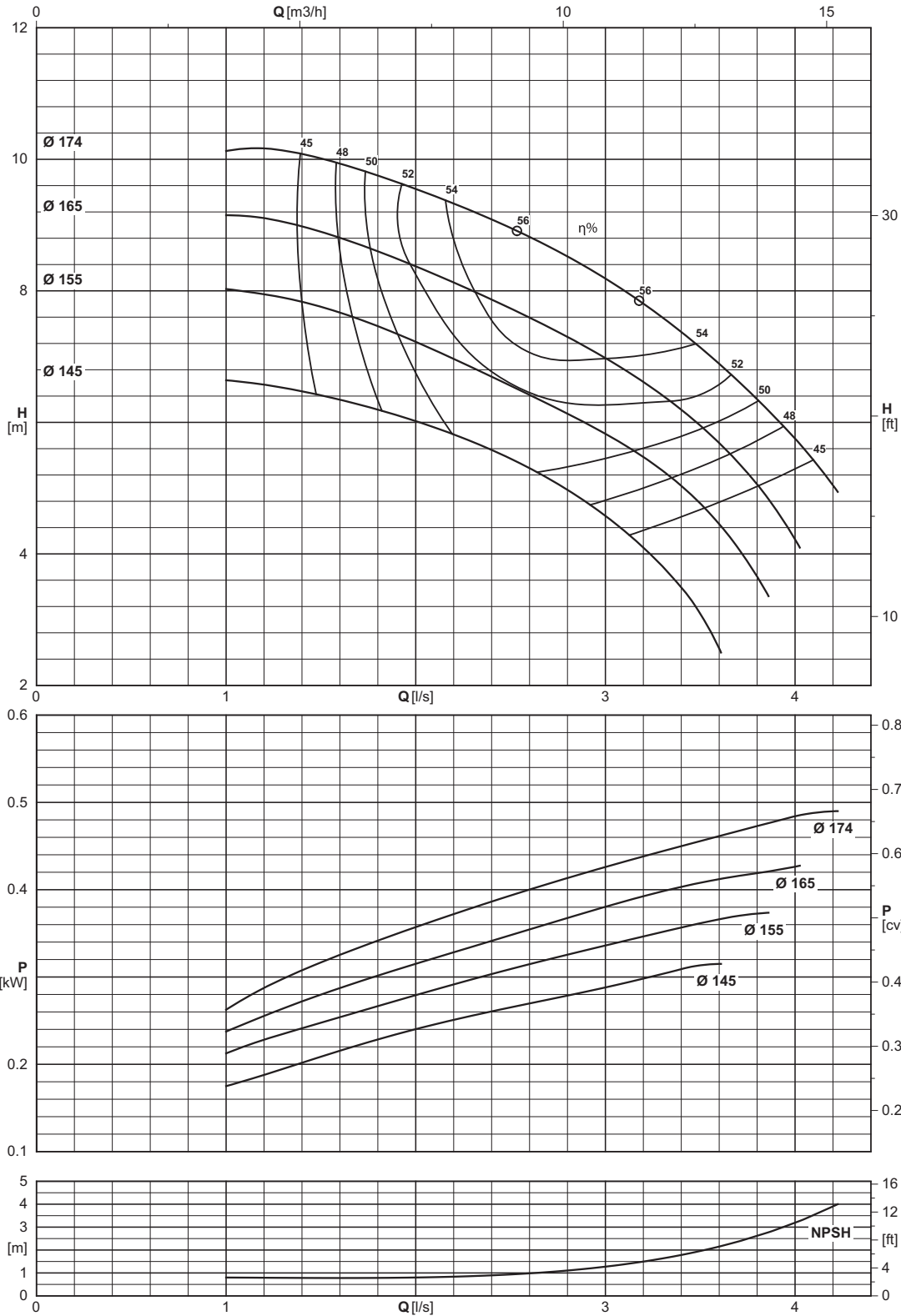

Type Type Tipo	Inlet maximum pressure (*) Pression maximale en aspiration (*) Pressione massima in aspirazione (*)	Dinamic momentum J Momentum dynamique J Momento dinamico J	
		With cast iron impellers Avec roues en fonte Con giranti in ghisa	With AISI 316 impellers Avec roues en AISI 316 Con giranti in AISI 316
		J = 1/4 PD <sup>2</sup>	
	[bar]	[kgm <sup>2</sup> ]	[kgm <sup>2</sup> ]
NC32-160	8	0,0069021	(F) 0,0078881

Construction reference standard EN733 (DIN24255)  
 (\*) Value referred to the impeller with maximum diameter.

Norme de référence construction EN733 (DIN24255)  
 (\*) Valeur se référant à la roue à ailettes avec le diamètre maximum.

Norma di riferimento costruttivo EN733 (DIN24255)  
 (\*) Valore riferito alla girante con diametro massimo.



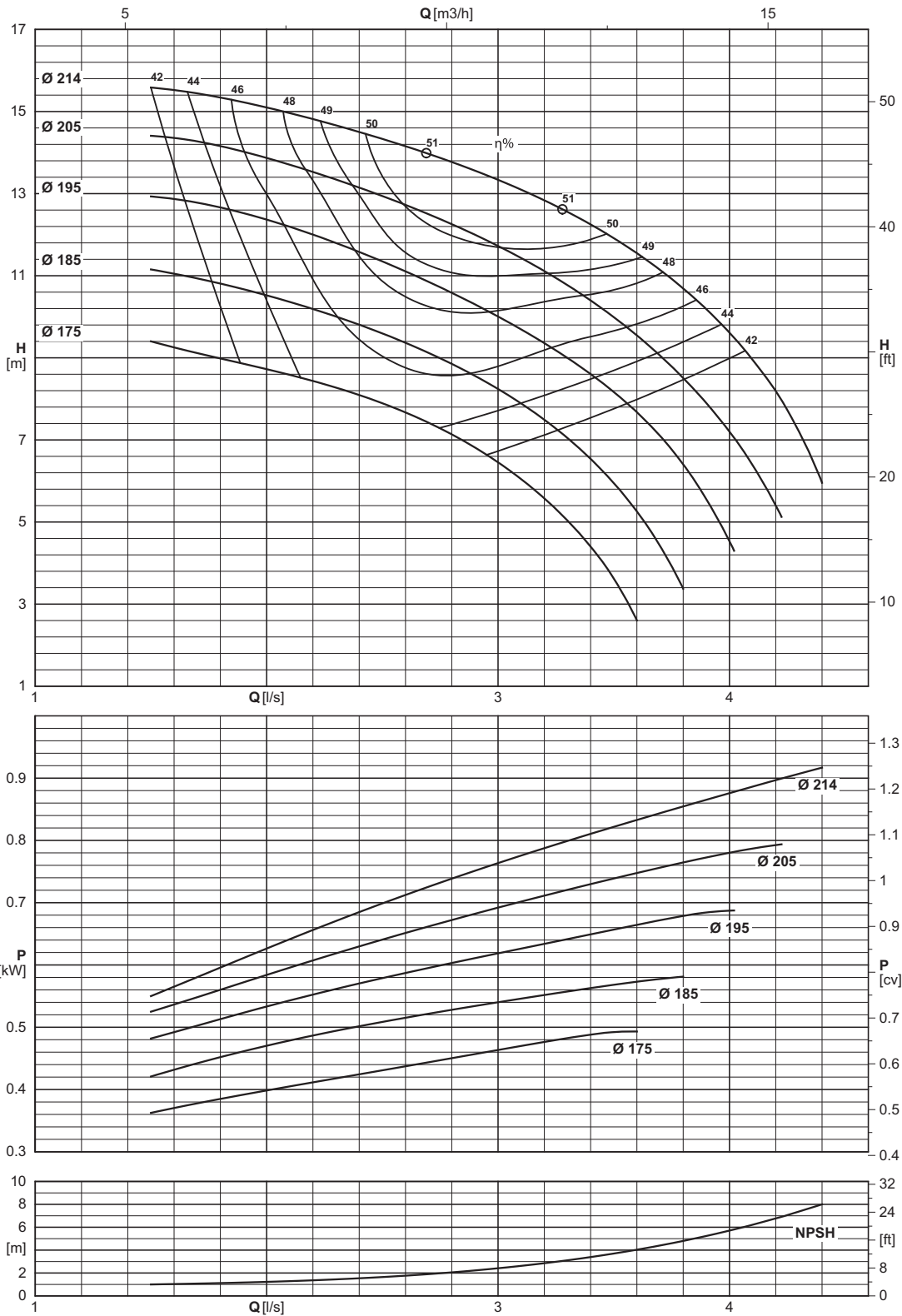

Type Type Tipo	Inlet maximum pressure (*) Pression maximale en aspiration (*) Pressione massima in aspirazione (*)	Dynamic momentum J Momentum dynamique J Momento dinamico J	
		With cast iron impellers Avec roues en fonte Con giranti in ghisa	With AISI 316 impellers Avec roues en AISI 316 Con giranti in AISI 316
		J=1/4PD²	
[bar]		[kgm²]	
NC32-200	7	0,0132814	(F) 0,0151787

Construction reference standard EN733 (DIN24255)  
 (\*) Value referred to the impeller with maximum diameter.

Norme de référence construction EN733 (DIN24255)  
 (\*) Valeur se référant à la roue à ailettes avec le diamètre maximum.

Norma di riferimento costruttivo EN733 (DIN24255)  
 (\*) Valore riferito alla girante con diametro massimo.

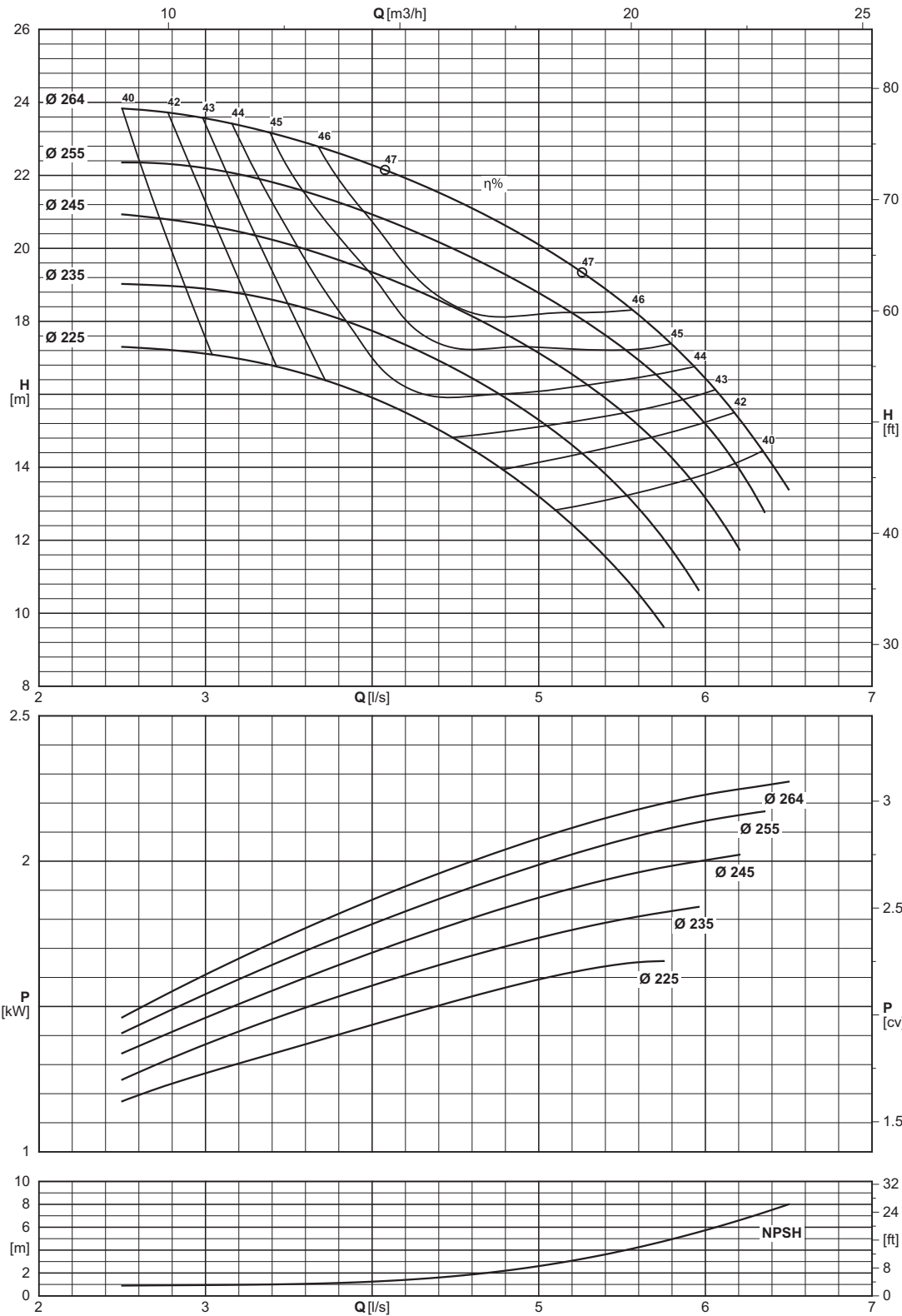

Type Type Tipo	Inlet maximum pressure (*) Pression maximale en aspiration (*) Pressione massima in aspirazione (*)	Dynamic momentum J Momentum dynamique J Momento dinamico J	
		With cast iron impellers Avec roues en fonte Con giranti in ghisa	With AISI 316 impellers Avec roues en AISI 316 Con giranti in AISI 316
		J = 1/4 PD <sup>2</sup>	
[bar]		[kgm <sup>2</sup> ]	
NC32-250	6	0,0297908	(F) 0,0340466

Construction reference standard EN733 (DIN24255)  
(\*) Value referred to the impeller with maximum diameter.

Norme de référence construction EN733 (DIN24255)  
(\*) Valeur se référant à la roue à ailettes avec le diamètre maximum.

Norma di riferimento costruttivo EN733 (DIN24255)  
(\*) Valore riferito alla girante con diametro massimo.

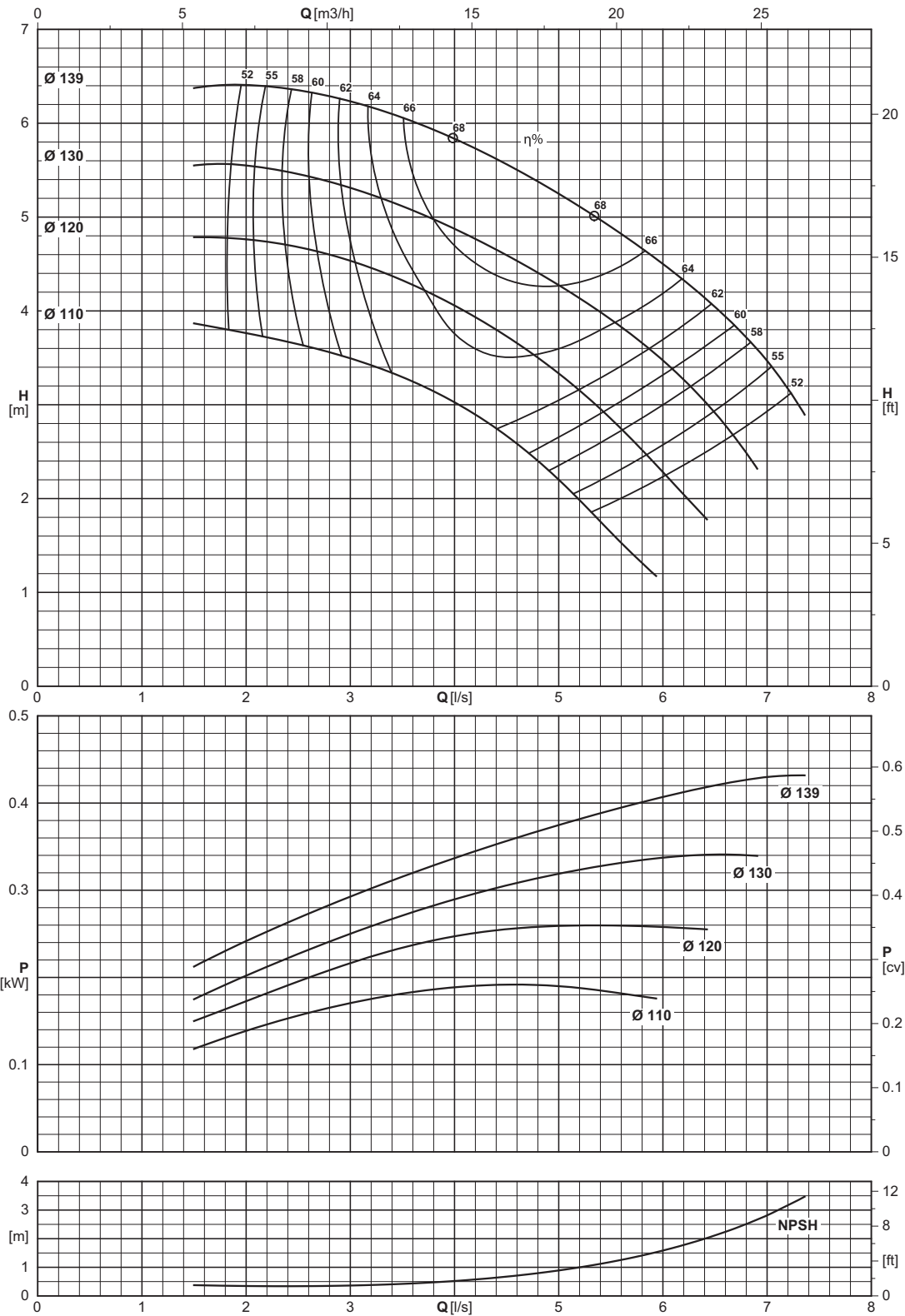

Type Type Tipo	Inlet maximum pressure (*) Pression maximale en aspiration (*) Pressione massima in aspirazione (*)	Dynamic momentum J Momentum dynamique J Momento dinamico J	
		With cast iron impellers Avec roues en fonte Con giranti in ghisa	With AISI 316 impellers Avec roues en AISI 316 Con giranti in AISI 316
		J=1/4PD <sup>2</sup>	
	[bar]	[kgm <sup>2</sup> ]	[kgm <sup>2</sup> ]
NC40-125	8	0,0028102	(F) 0,0032117

Construction reference standard EN733 (DIN24255)  
 (\*) Value referred to the impeller with maximum diameter.

Norme de référence construction EN733 (DIN24255)  
 (\*) Valeur se référant à la roue à ailettes avec le diamètre maximum.

Norma di riferimento costruttivo EN733 (DIN24255)  
 (\*) Valore riferito alla girante con diametro massimo.

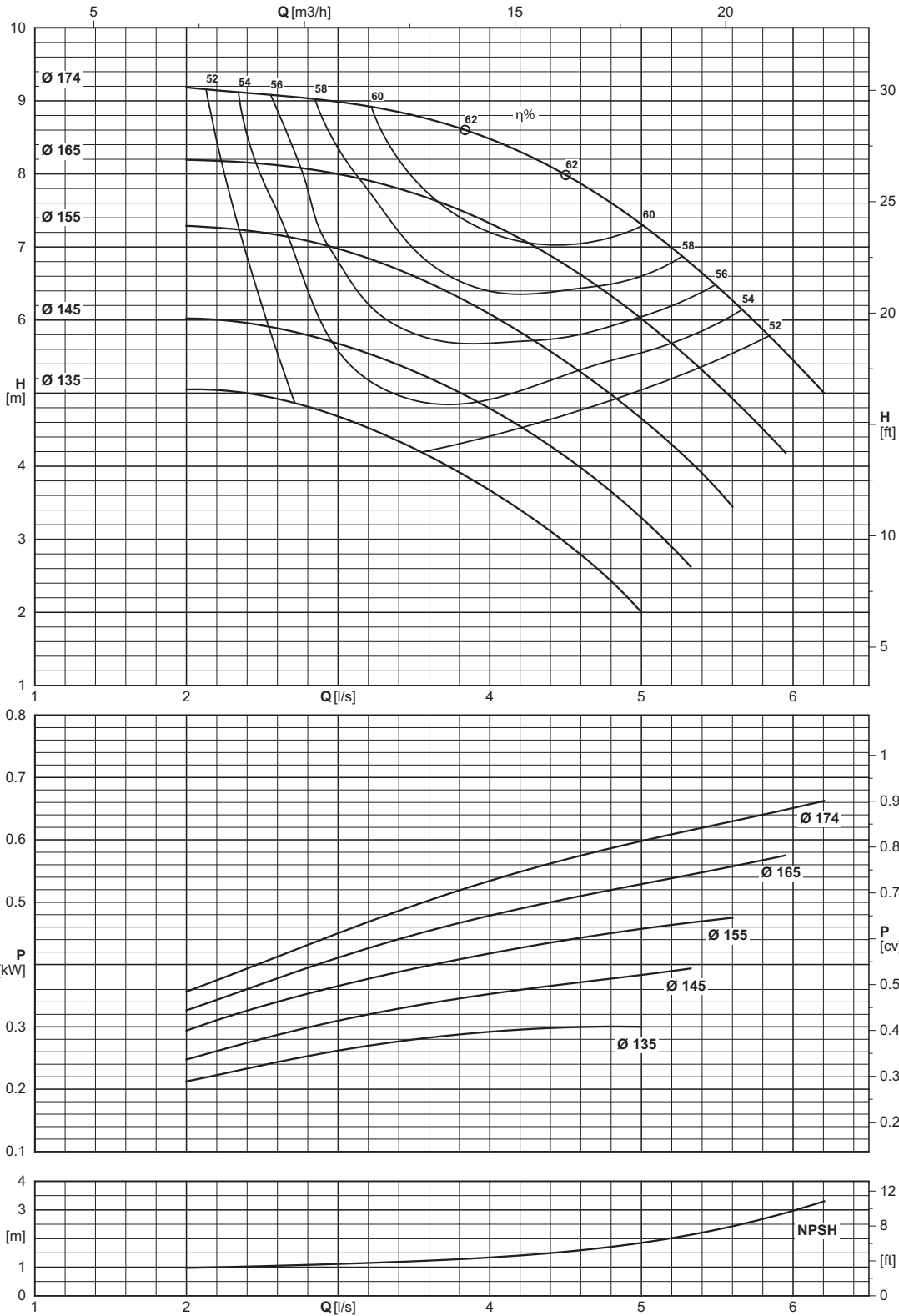

Type Type Tipo	Inlet maximum pressure (*) Pression maximale en aspiration (*) Pressione massima in aspirazione (*)	Dinamic momentum J Momentum dynamique J Momento dinamico J	
		With cast iron impellers Avec roues en fonte Con giranti in ghisa	With AISI 316 impellers Avec roues en AISI 316 Con giranti in AISI 316
		J=1/4PD²	
	[bar]	[kgm²]	[kgm²]
NC40-160	8	0,0077563	(F) 0,0088643

Construction reference standard EN733 (DIN24255)  
(\*) Value referred to the impeller with maximum diameter.

Norme de référence construction EN733 (DIN24255)  
(\*) Valeur se référant à la roue à ailettes avec le diamètre maximum.

Norma di riferimento costruttivo EN733 (DIN24255)  
(\*) Valore riferito alla girante con diametro massimo.

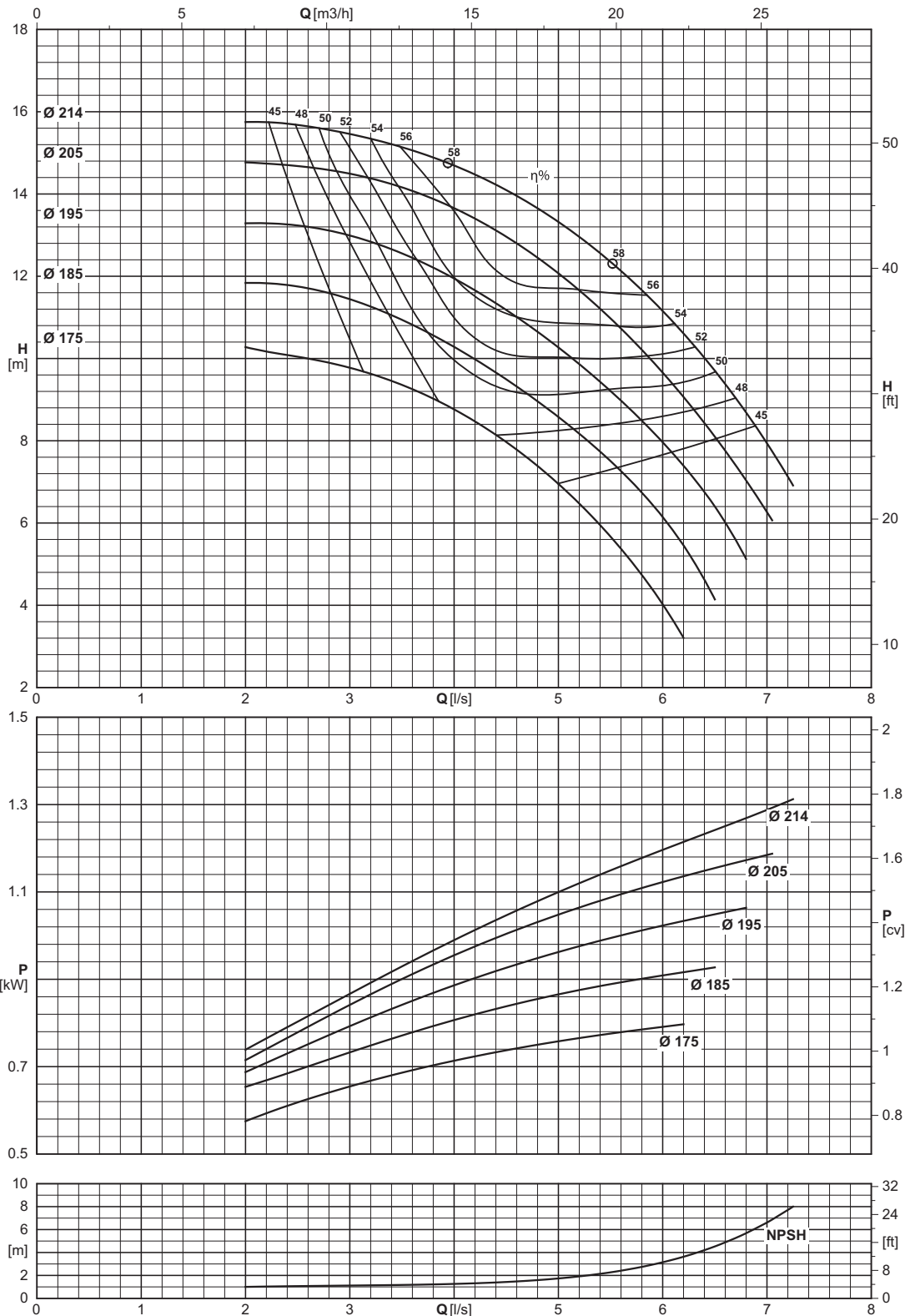

Type Type Tipo	Inlet maximum pressure (*) Pression maximale en aspiration (*) Pressione massima in aspirazione (*)	Dynamic momentum J Momentum dynamique J Momento dinamico J	
		With cast iron impellers Avec roues en fonte Con giranti in ghisa	With AISI 316 impellers Avec roues en AISI 316 Con giranti in AISI 316
		J = 1/4 PD <sup>2</sup>	
[bar]		[kgm <sup>2</sup> ]	
NC40-200	7	0,0158799	(F) 0,0181484

Construction reference standard EN733 (DIN24255)  
 (\*) Value referred to the impeller with maximum diameter.

Norme de référence construction EN733 (DIN24255)  
 (\*) Valeur se référant à la roue à ailettes avec le diamètre maximum.

Norma di riferimento costruttivo EN733 (DIN24255)  
 (\*) Valore riferito alla girante con diametro massimo.

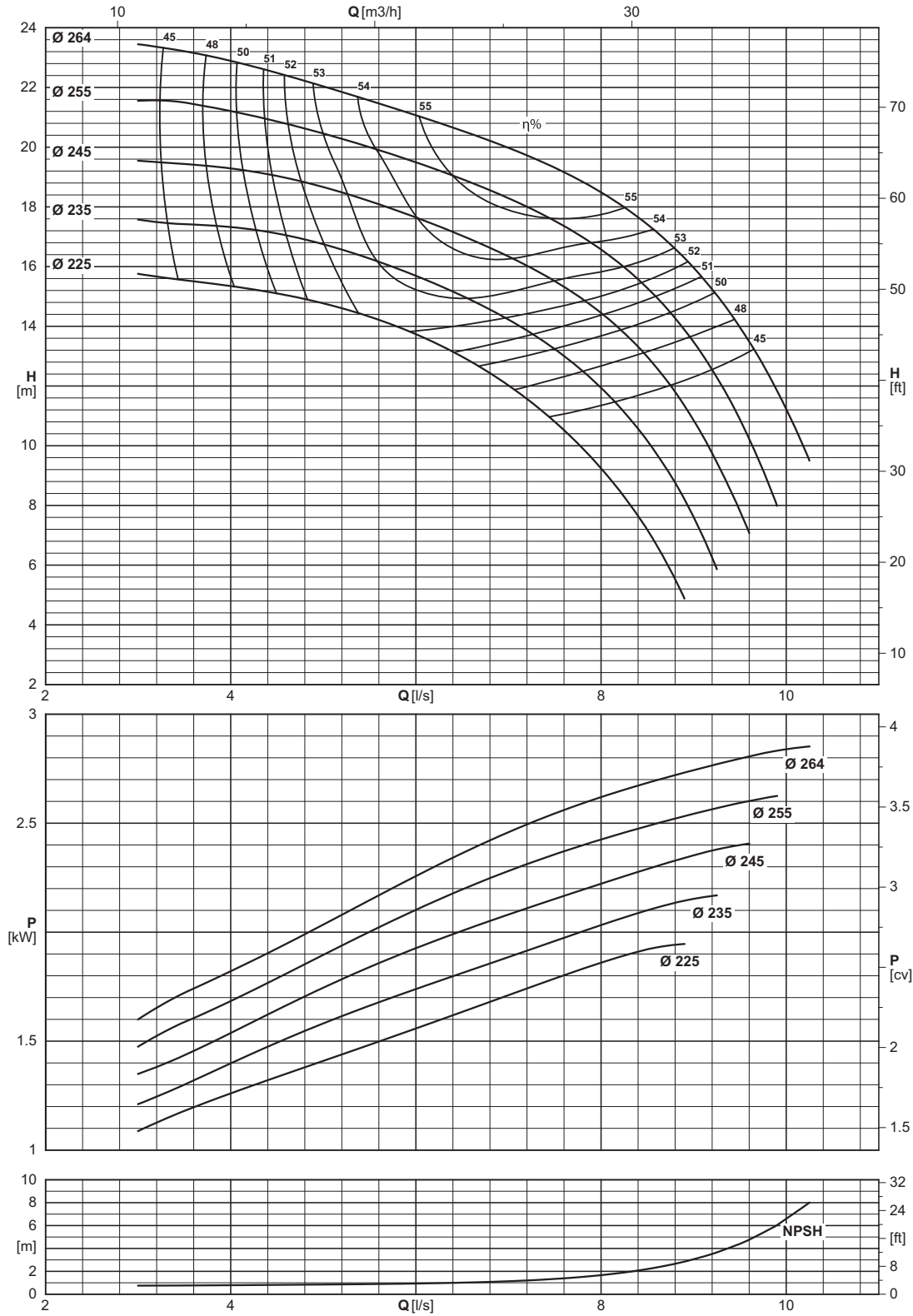

Type Type Tipo	Inlet maximum pressure (*) Pression maximale en aspiration (*) Pressione massima in aspirazione (*)	Dinamic momentum J Momentum dynamique J Momento dinamico J	
		With cast iron impellers Avec roues en fonte Con giranti in ghisa	With AISI 316 impellers Avec roues en AISI 316 Con giranti in AISI 316
		J = 1/4 PD <sup>2</sup>	
	[bar]	[kgm <sup>2</sup> ]	[kgm <sup>2</sup> ]
NC40-250	6	0,0411814	(F) 0,0470645

Construction reference standard EN733 (DIN24255)  
(\*) Value referred to the impeller with maximum diameter.

Norme de référence construction EN733 (DIN24255)  
(\*) Valeur se référant à la roue à ailettes avec le diamètre maximum.

Norma di riferimento costruttivo EN733 (DIN24255)  
(\*) Valore riferito alla girante con diametro massimo.

Operating data  
 Caracteristiques de fonctionnement  
 Caratteristiche di funzionamento

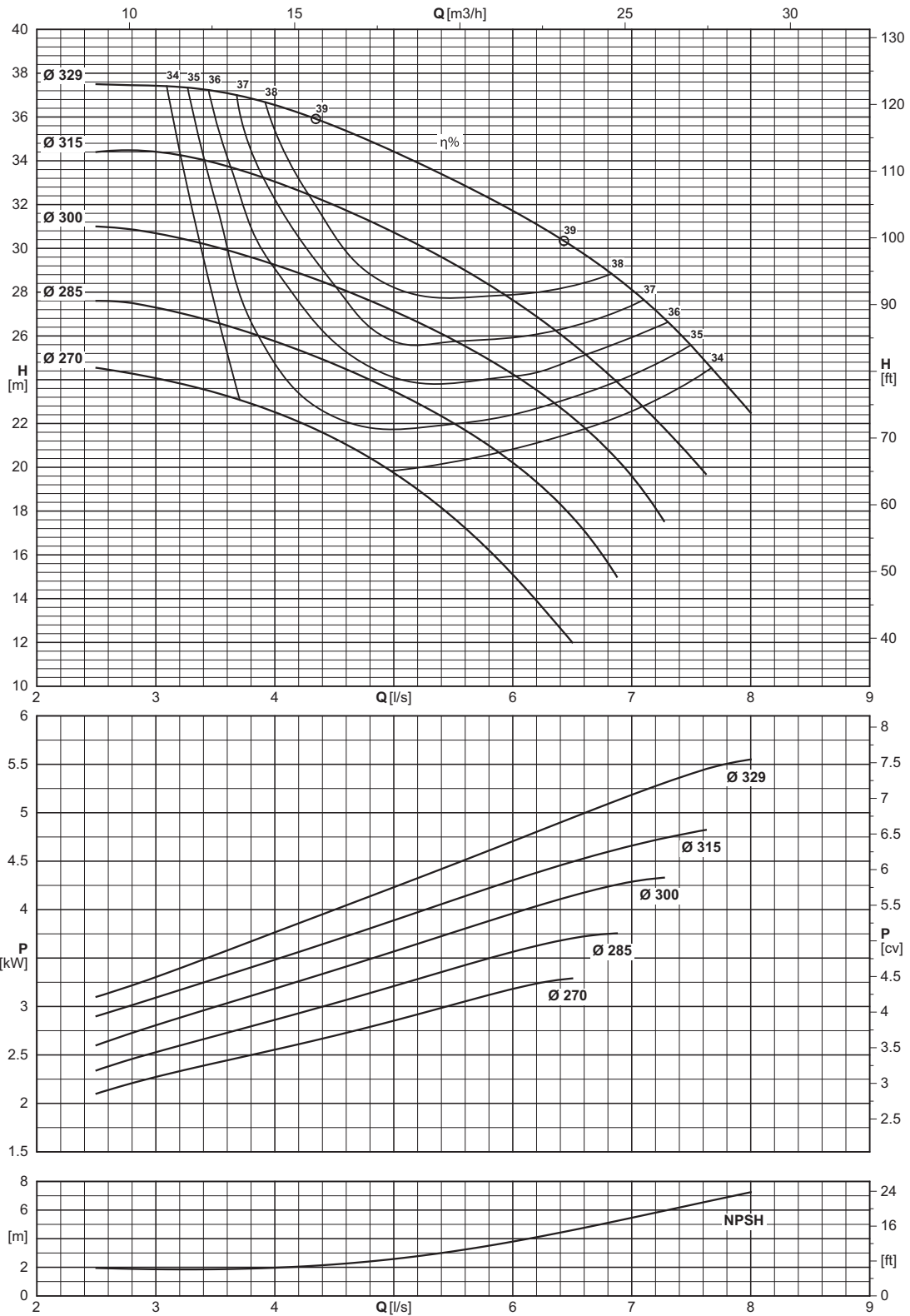

Type Type Tipo	Inlet maximum pressure (*) Pression maximale en aspiration (*) Pressione massima in aspirazione (*)	Dynamic momentum J Momentum dynamique J Momento dinamico J	
		With cast iron impellers Avec roues en fonte Con giranti in ghisa	With AISI 316 impellers Avec roues en AISI 316 Con giranti in AISI 316
		J = 1/4 PD <sup>2</sup>	
	[bar]	[kgm <sup>2</sup> ]	[kgm <sup>2</sup> ]
NC40-315	5	0,1049366	(F) 0,1199275

Construction reference standard EN733 (DIN24255)  
 (\*) Value referred to the impeller with maximum diameter.

Norme de référence construction EN733 (DIN24255)  
 (\*) Valeur se référant à la roue à ailettes avec le diamètre maximum.

Norma di riferimento costruttivo EN733 (DIN24255)  
 (\*) Valore riferito alla girante con diametro massimo.

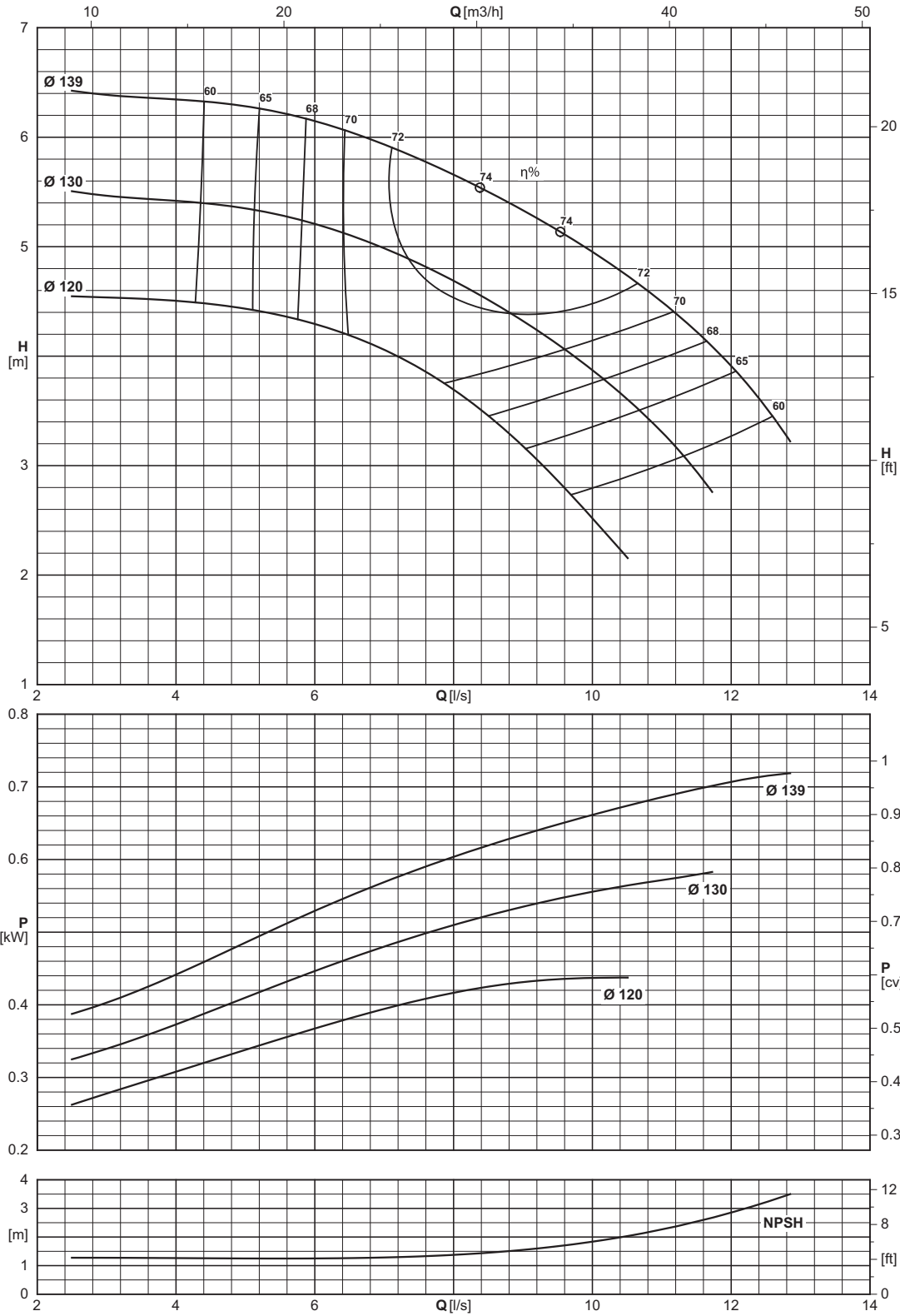

Type Type Tipo	Inlet maximum pressure (*) Pression maximale en aspiration (*) Pressione massima in aspirazione (*)	Dinamic momentum J Momentum dynamique J Momento dinamico J	
		With cast iron impellers Avec roues en fonte Con giranti in ghisa	With AISI 316 impellers Avec roues en AISI 316 Con giranti in AISI 316
		J = 1/4 PD <sup>2</sup>	
[bar]		[kgm <sup>2</sup> ]	
NC50-125	8	0,0036977	(F) 0,0042259

Construction reference standard EN733 (DIN24255)  
(\*) Value referred to the impeller with maximum diameter.

Norme de référence construction EN733 (DIN24255)  
(\*) Valeur se référant à la roue à ailettes avec le diamètre maximum.

Norma di riferimento costruttivo EN733 (DIN24255)  
(\*) Valore riferito alla girante con diametro massimo.



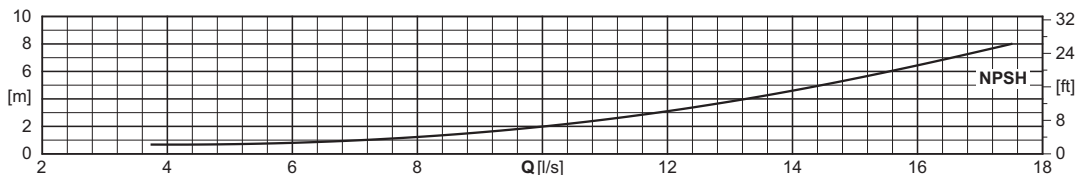
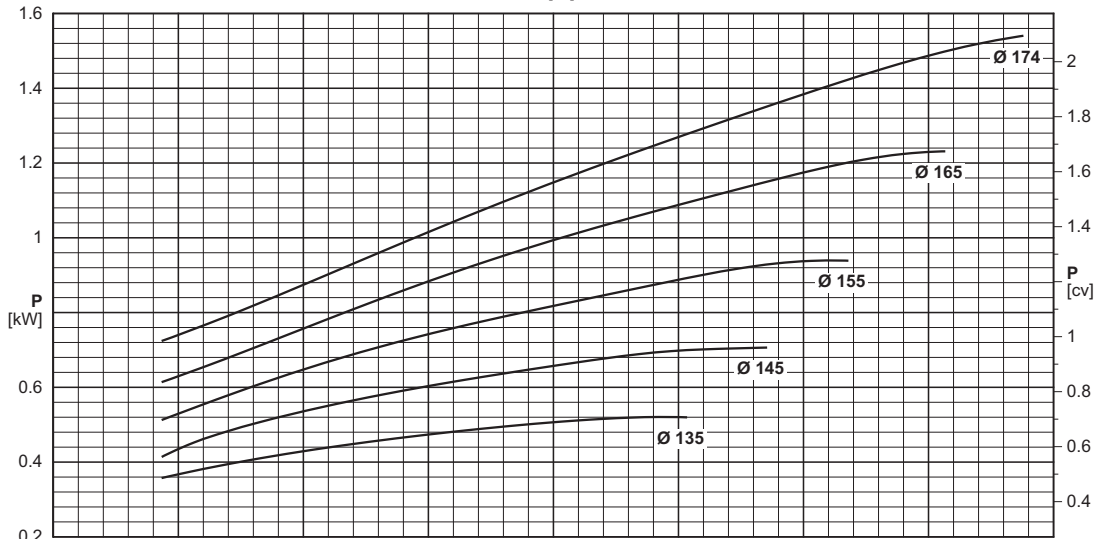
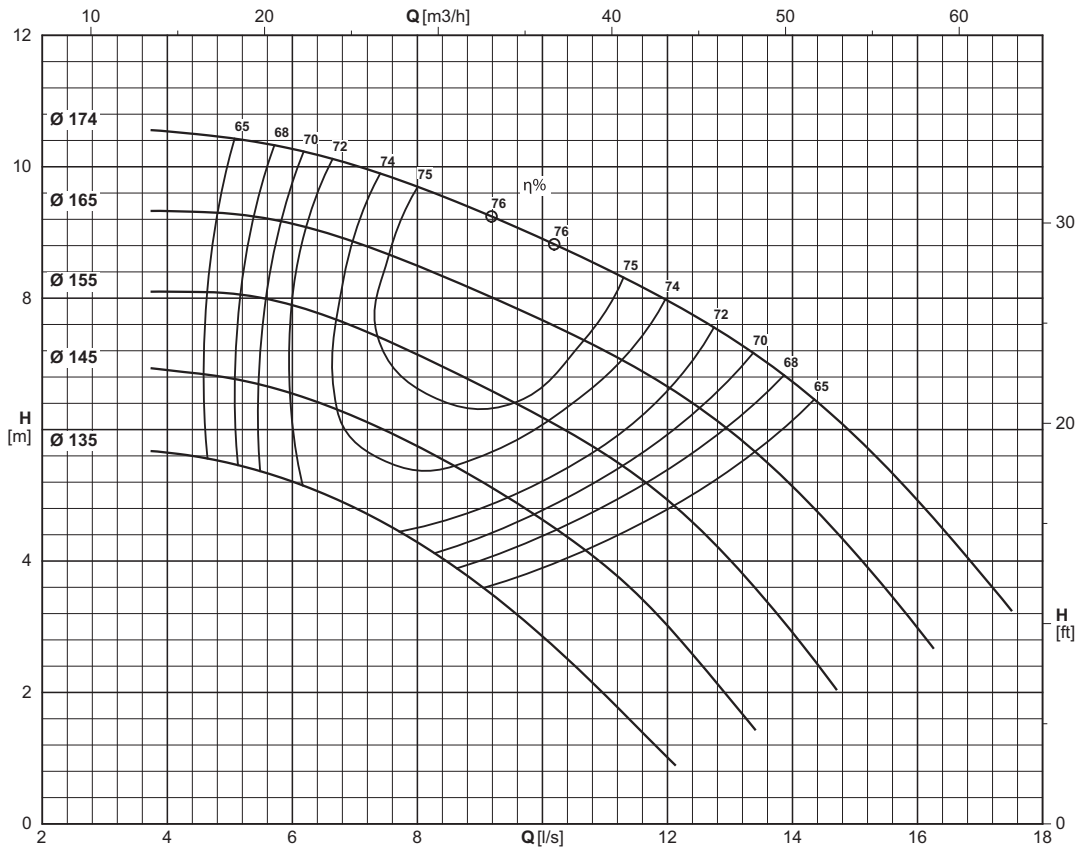

Type Type Tipo	Inlet maximum pressure (*) Pression maximale en aspiration (*) Pressione massima in aspirazione (*)	Dinamic momentum J Momentum dynamique J Momento dinamico J	
		With cast iron impellers Avec roues en fonte Con giranti in ghisa	With AISI 316 impellers Avec roues en AISI 316 Con giranti in AISI 316
		J=1/4PD <sup>2</sup>	
[bar]		[kgm <sup>2</sup> ]	
NC50-160	8	0,0066337	(F) 0,0075814

Construction reference standard EN733 (DIN24255)  
 (\*) Value referred to the impeller with maximum diameter.

Norme de référence construction EN733 (DIN24255)  
 (\*) Valeur se référant à la roue à ailettes avec le diamètre maximum.

Norma di riferimento costruttivo EN733 (DIN24255)  
 (\*) Valore riferito alla girante con diametro massimo.

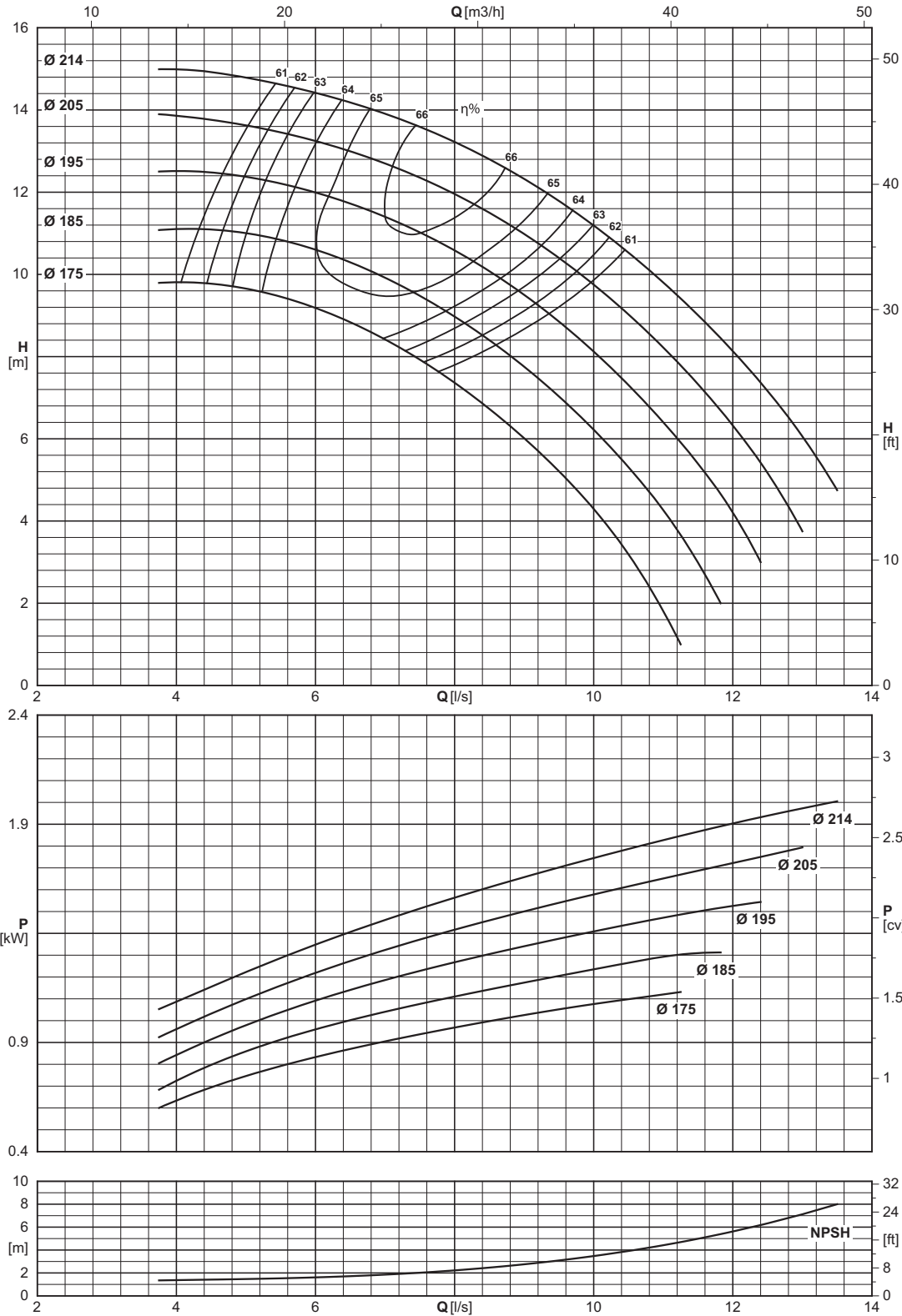

Type Type Tipo	Inlet maximum pressure (*) Pression maximale en aspiration (*) Pressione massima in aspirazione (*)	Dynamic momentum J Momentum dynamique J Momento dinamico J	
		With cast iron impellers Avec roues en fonte Con giranti in ghisa	With AISI 316 impellers Avec roues en AISI 316 Con giranti in AISI 316
		J = 1/4 PD <sup>2</sup>	
[bar]		[kgm <sup>2</sup> ]	
NC50-200	7	0,0158799	(F) 0,0181484

Construction reference standard EN733 (DIN24255)  
(\*) Value referred to the impeller with maximum diameter.

Norme de référence construction EN733 (DIN24255)  
(\*) Valeur se référant à la roue à ailettes avec le diamètre maximum.

Norma di riferimento costruttivo EN733 (DIN24255)  
(\*) Valore riferito alla girante con diametro massimo.

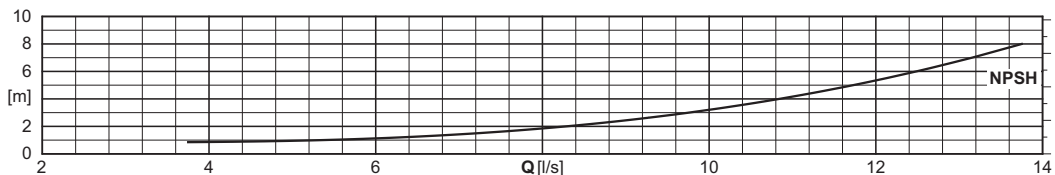
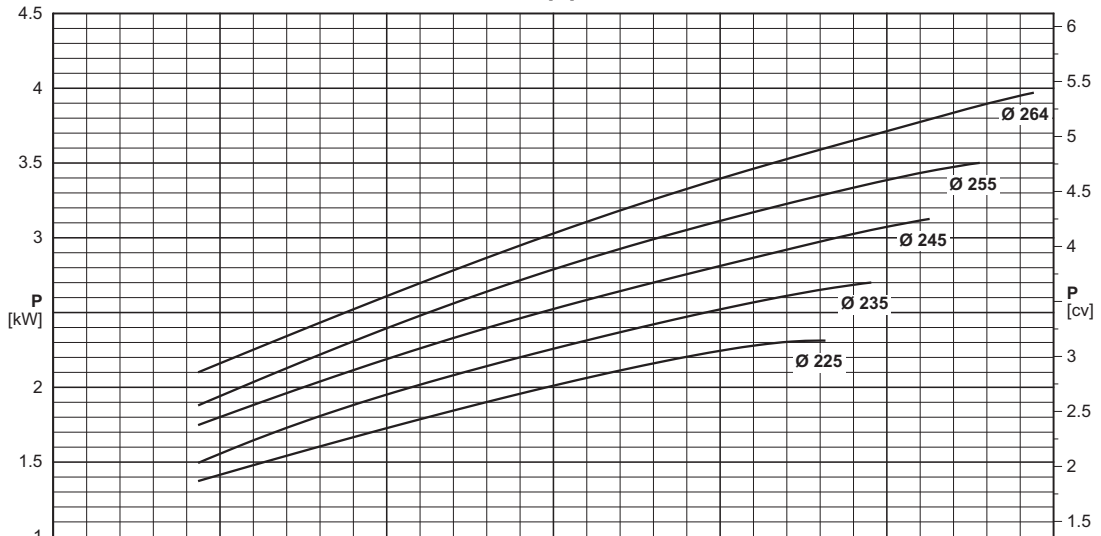
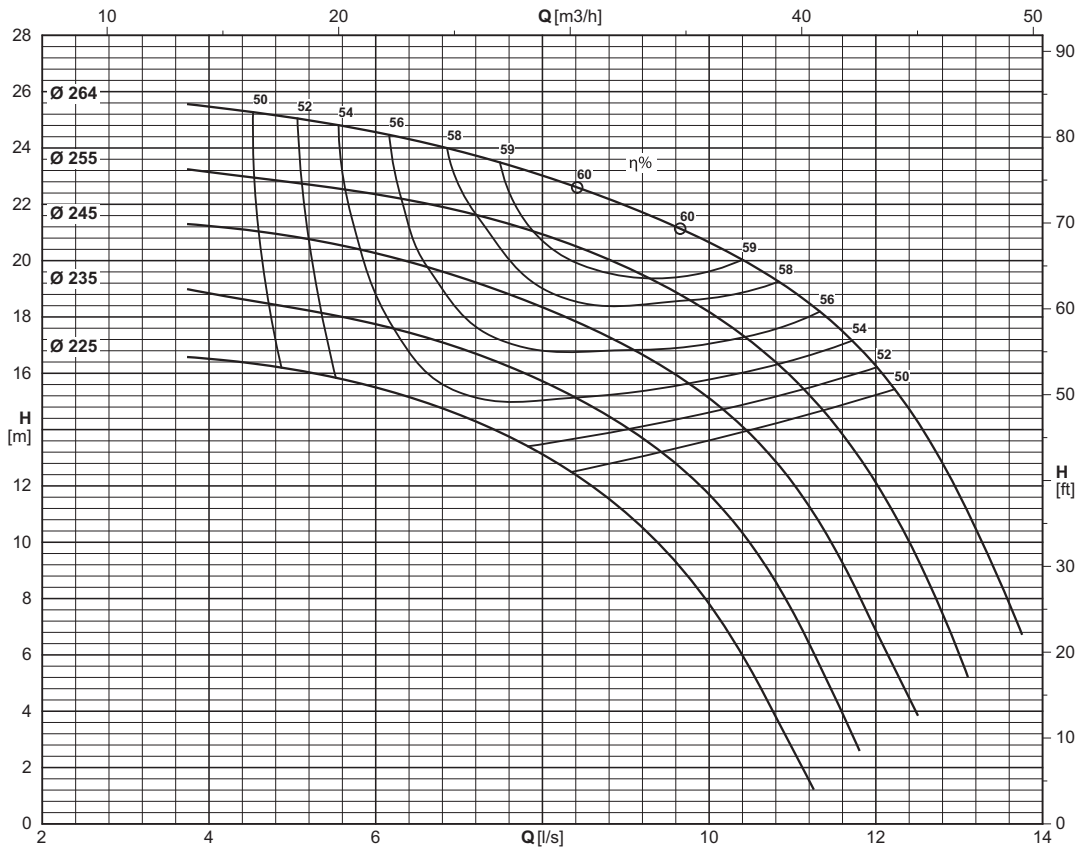

Type Type Tipo	Inlet maximum pressure (*) Pression maximale en aspiration (*) Pressione massima in aspirazione (*)	Dynamic momentum J Momentum dynamique J Momento dinamico J	
		With cast iron impellers Avec roues en fonte Con giranti in ghisa	With AISI 316 impellers Avec roues en AISI 316 Con giranti in AISI 316
		$J = \frac{1}{4}PD^2$	
	[bar]	[kgm <sup>2</sup> ]	
NC50-250	6	0,0385528	(F) 0,0440603

Construction reference standard EN733 (DIN24255)  
 (\*) Value referred to the impeller with maximum diameter.

Norme de référence construction EN733 (DIN24255)  
 (\*) Valeur se référant à la roue à ailettes avec le diamètre maximum.

Norma di riferimento costruttivo EN733 (DIN24255)  
 (\*) Valore riferito alla girante con diametro massimo.

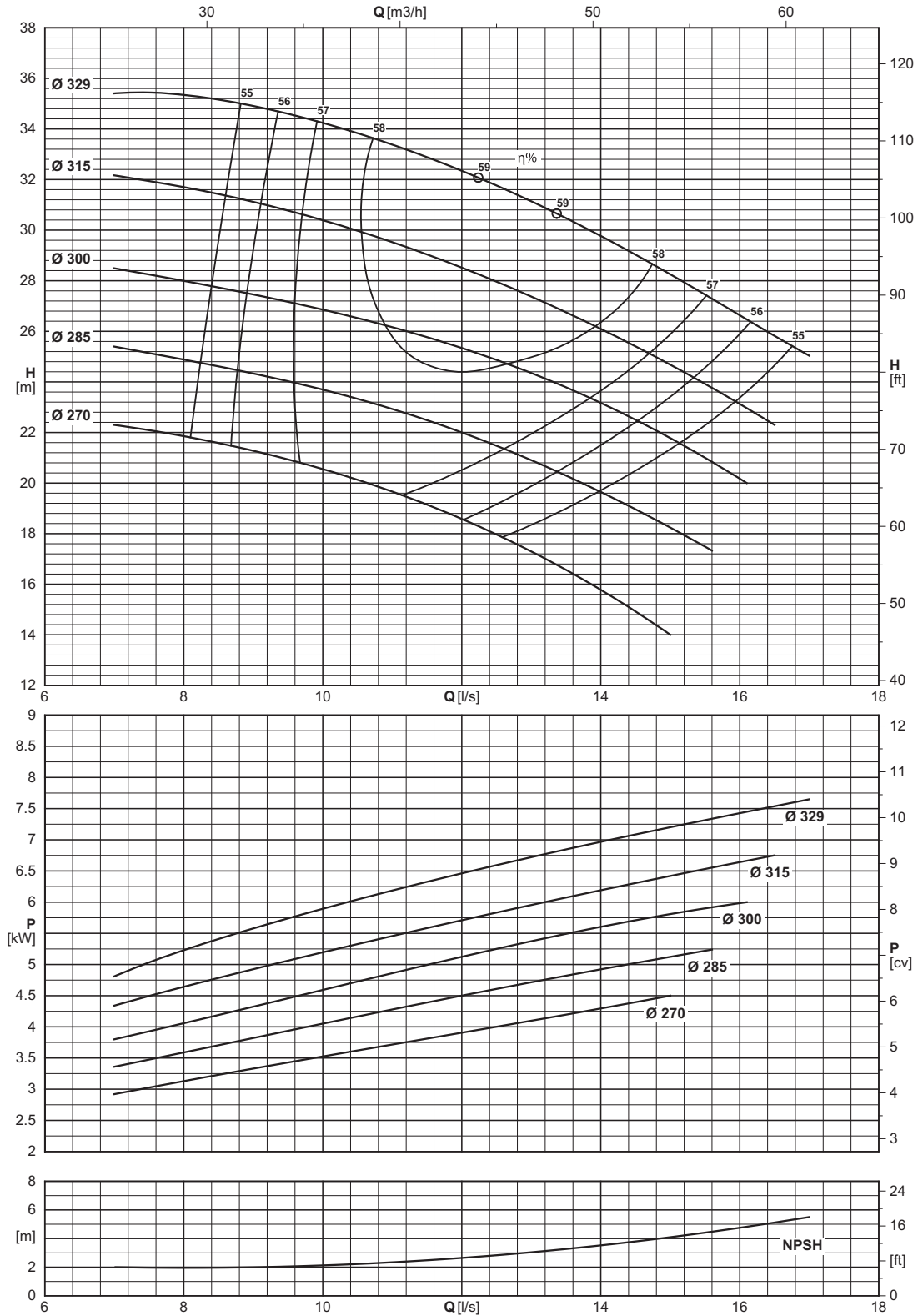

Type Type Tipo	Inlet maximum pressure (*) Pression maximale en aspiration (*) Pressione massima in aspirazione (*)	Dinamic momentum J Momentum dynamique J Momento dinamico J	
		With cast iron impellers Avec roues en fonte Con giranti in ghisa	With AISI 316 impellers Avec roues en AISI 316 Con giranti in AISI 316
		J=1/4PD <sup>2</sup>	
	[bar]	[kgm <sup>2</sup> ]	
NC50-315	5	0,101595	(F) 0,1161086

Construction reference standard EN733 (DIN24255)  
(\*) Value referred to the impeller with maximum diameter.

Norme de référence construction EN733 (DIN24255)  
(\*) Valeur se référant à la roue à ailettes avec le diamètre maximum.

Norma di riferimento costruttivo EN733 (DIN24255)  
(\*) Valore riferito alla girante con diametro massimo.

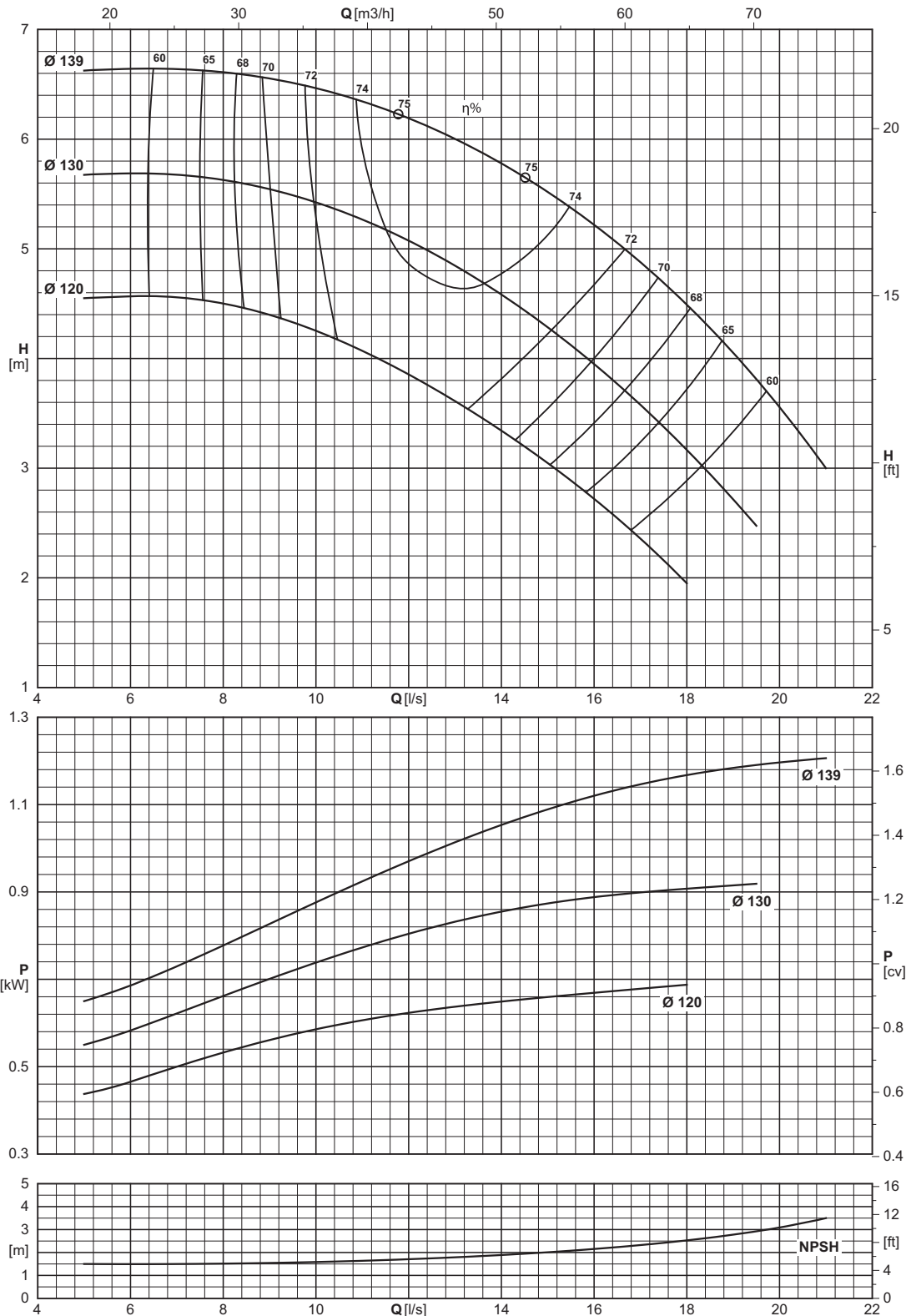

Type Type Tipo	Inlet maximum pressure (*) Pression maximale en aspiration (*) Pressione massima in aspirazione (*)	Dynamic momentum J Momentum dynamique J Momento dinamico J	
		With cast iron impellers Avec roues en fonte Con giranti in ghisa	With AISI 316 impellers Avec roues en AISI 316 Con giranti in AISI 316
		J=1/4PD <sup>2</sup>	
	[bar]	[kgm <sup>2</sup> ]	[kgm <sup>2</sup> ]
NC65-125	8	0,0044372	(F) 0,0050711

Construction reference standard EN733 (DIN24255)  
 (\*) Value referred to the impeller with maximum diameter.

Norme de référence construction EN733 (DIN24255)  
 (\*) Valeur se référant à la roue à ailettes avec le diamètre maximum.

Norma di riferimento costruttivo EN733 (DIN24255)  
 (\*) Valore riferito alla girante con diametro massimo.

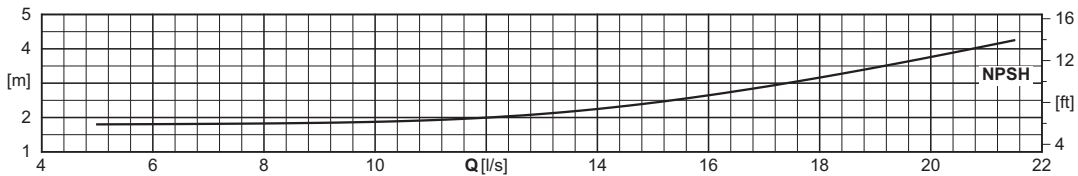
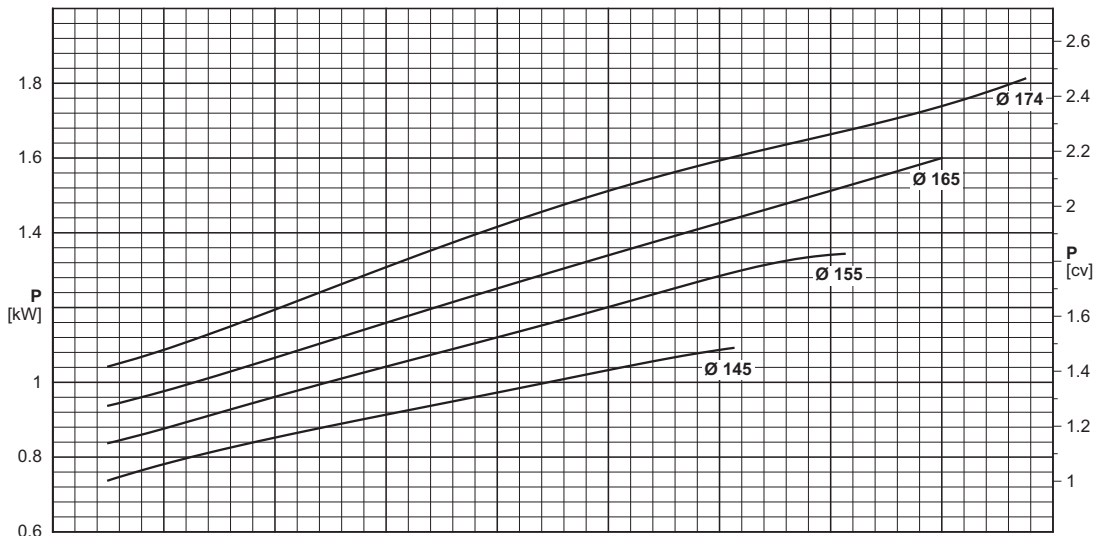
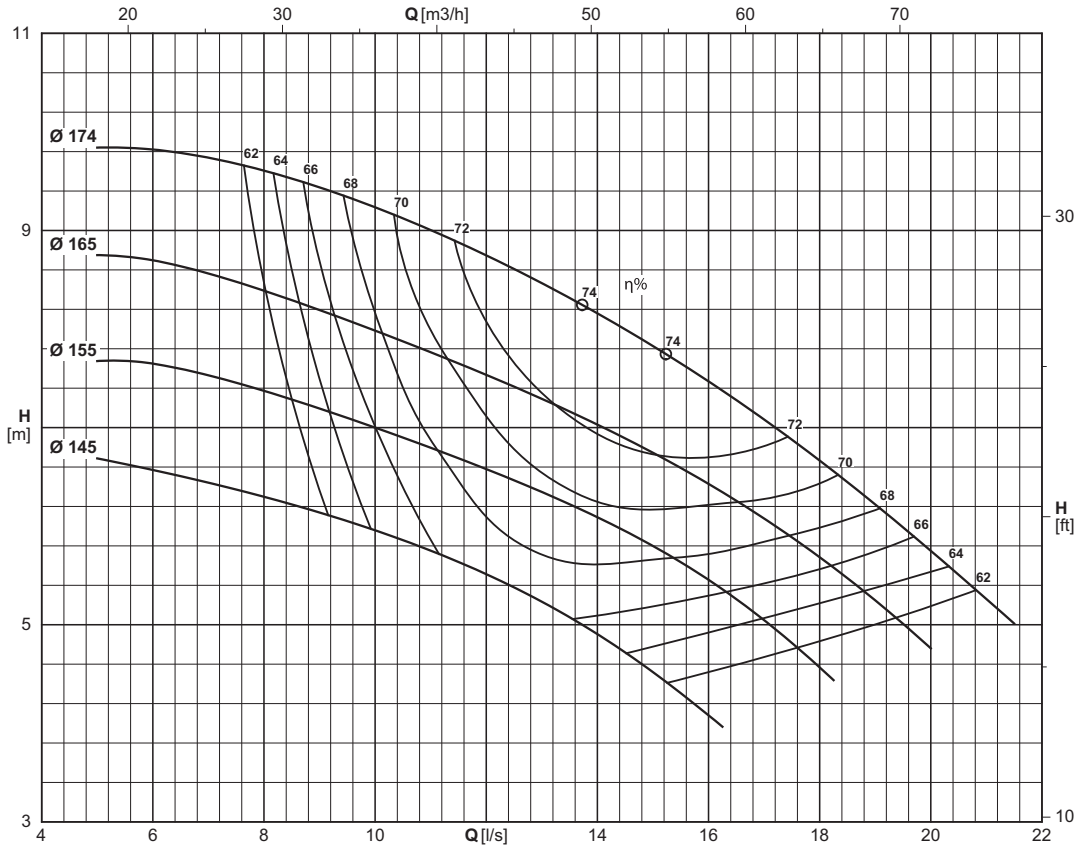

Type Type Tipo	Inlet maximum pressure (*) Pression maximale en aspiration (*) Pressione massima in aspirazione (*)	Dinamic momentum J Momentum dynamique J Momento dinamico J	
		With cast iron impellers Avec roues en fonte Con giranti in ghisa	With AISI 316 impellers Avec roues en AISI 316 Con giranti in AISI 316
		J = 1/4 PD <sup>2</sup>	
[bar]		[kgm <sup>2</sup> ]	
NC65-160	8	0,0078607	(F) 0,0089837

Construction reference standard EN733 (DIN24255)  
 (\*) Value referred to the impeller with maximum diameter.

Norme de référence construction EN733 (DIN24255)  
 (\*) Valeur se référant à la roue à ailettes avec le diamètre maximum.

Norma di riferimento costruttivo EN733 (DIN24255)  
 (\*) Valore riferito alla girante con diametro massimo.

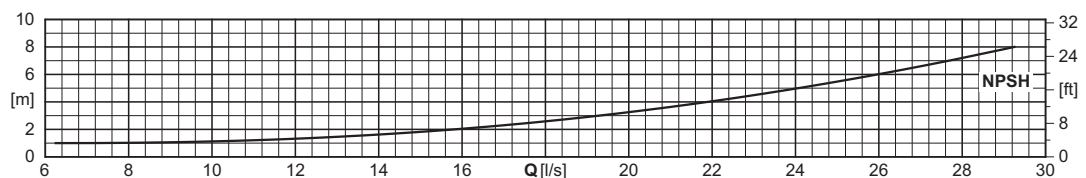
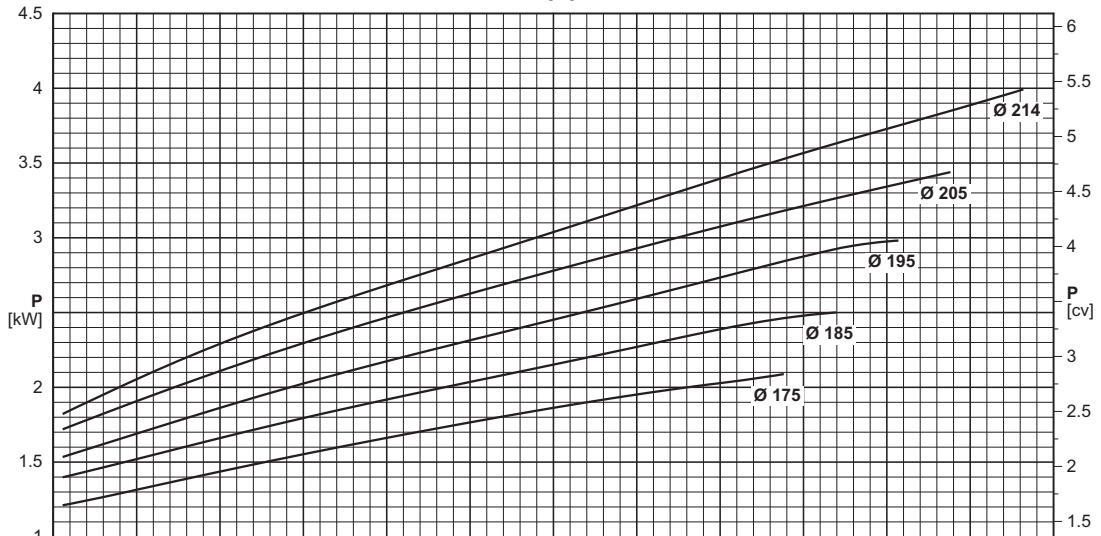
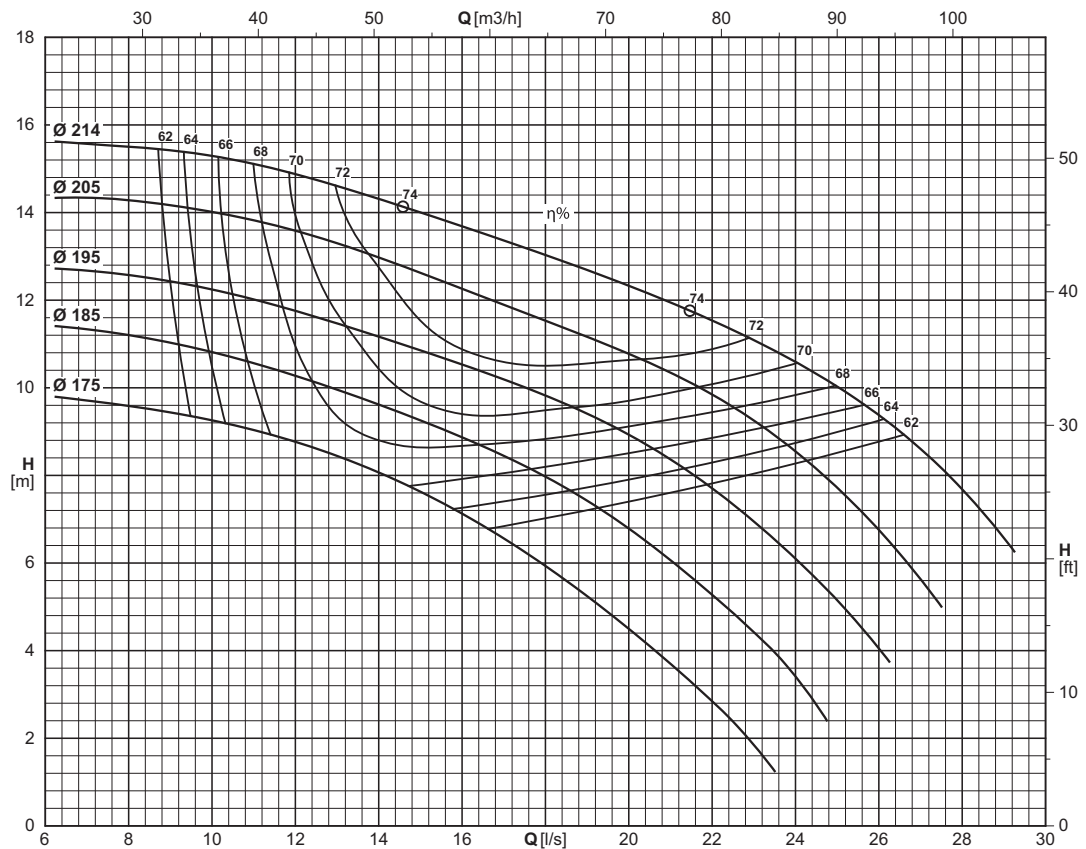

Type Type Tipo	Inlet maximum pressure (*) Pression maximale en aspiration (*) Pressione massima in aspirazione (*)	Dynamic momentum J Momentum dynamique J Momento dinamico J	
		With cast iron impellers Avec roues en fonte Con giranti in ghisa	With AISI 316 impellers Avec roues en AISI 316 Con giranti in AISI 316
		J=1/4PD <sup>2</sup>	
[bar]		[kgm <sup>2</sup> ]	
NC65-200	7	0,0158799	(F) 0,0181484

Construction reference standard EN733 (DIN24255)  
 (\*) Value referred to the impeller with maximum diameter.

Norme de référence construction EN733 (DIN24255)  
 (\*) Valeur se référant à la roue à ailettes avec le diamètre maximum.

Norma di riferimento costruttivo EN733 (DIN24255)  
 (\*) Valore riferito alla girante con diametro massimo.

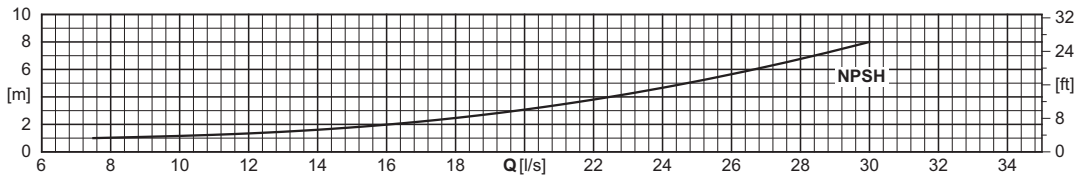
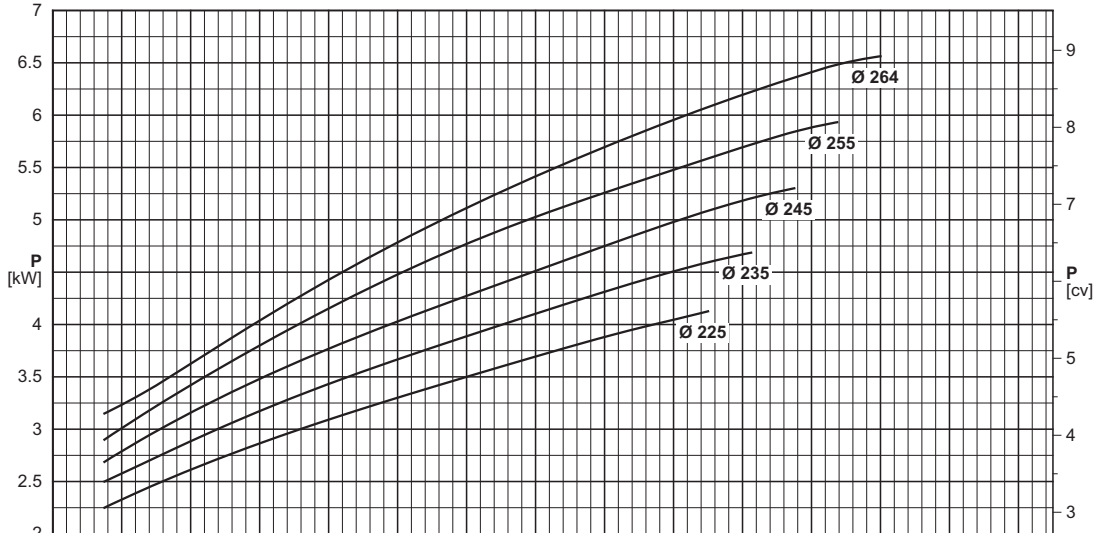
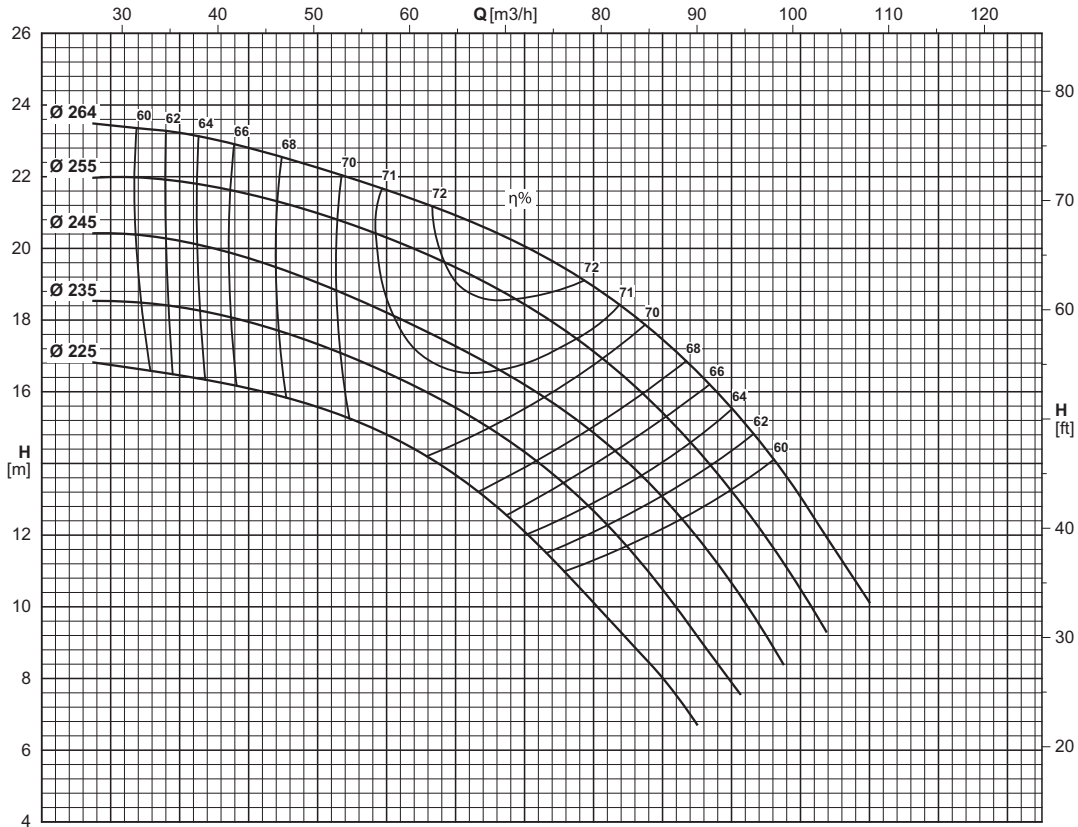

Type Type Tipo	Inlet maximum pressure (*) Pression maximale en aspiration (*) Pressione massima in aspirazione (*)	Dynamic momentum J Momentum dynamique J Momento dinamico J	
		With cast iron impellers Avec roues en fonte Con giranti in ghisa	With AISI 316 impellers Avec roues en AISI 316 Con giranti in AISI 316
		J = 1/4 PD²	
	[bar]	[kgm²]	[kgm²]
NC65-250	6	0,04405	(F) 0,0503429

Construction reference standard EN733 (DIN24255)  
 (\*) Value referred to the impeller with maximum diameter.

Norme de référence construction EN733 (DIN24255)  
 (\*) Valeur se référant à la roue à ailettes avec le diamètre maximum.

Norma di riferimento costruttivo EN733 (DIN24255)  
 (\*) Valore riferito alla girante con diametro massimo.



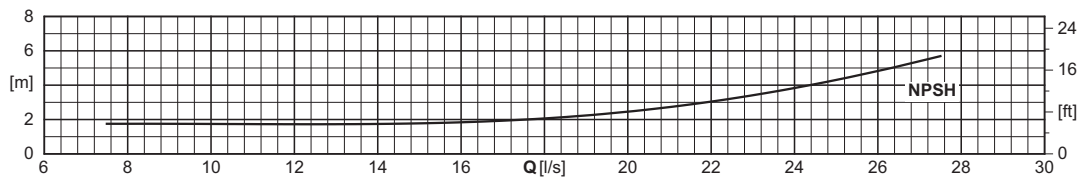
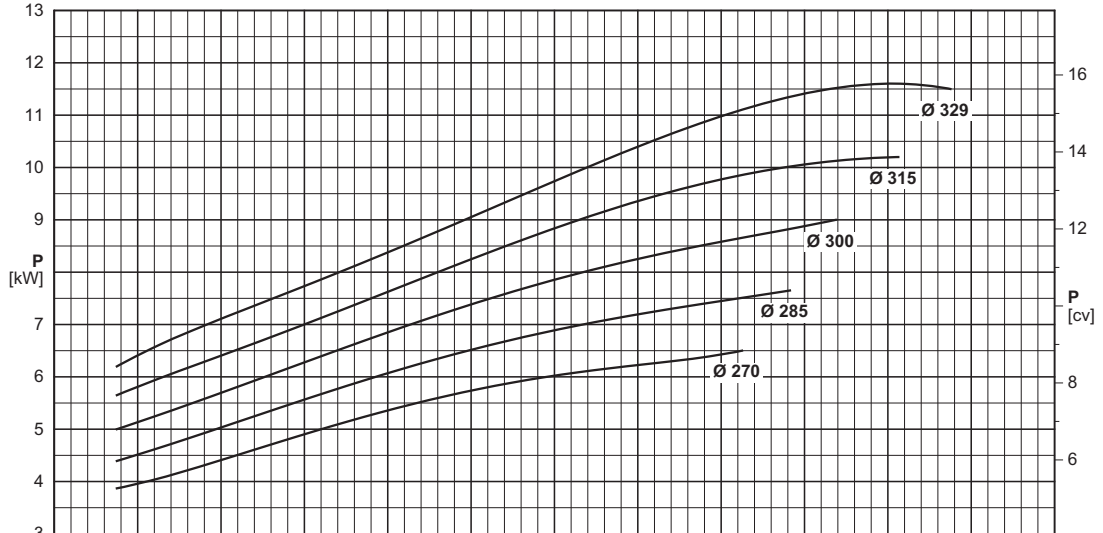
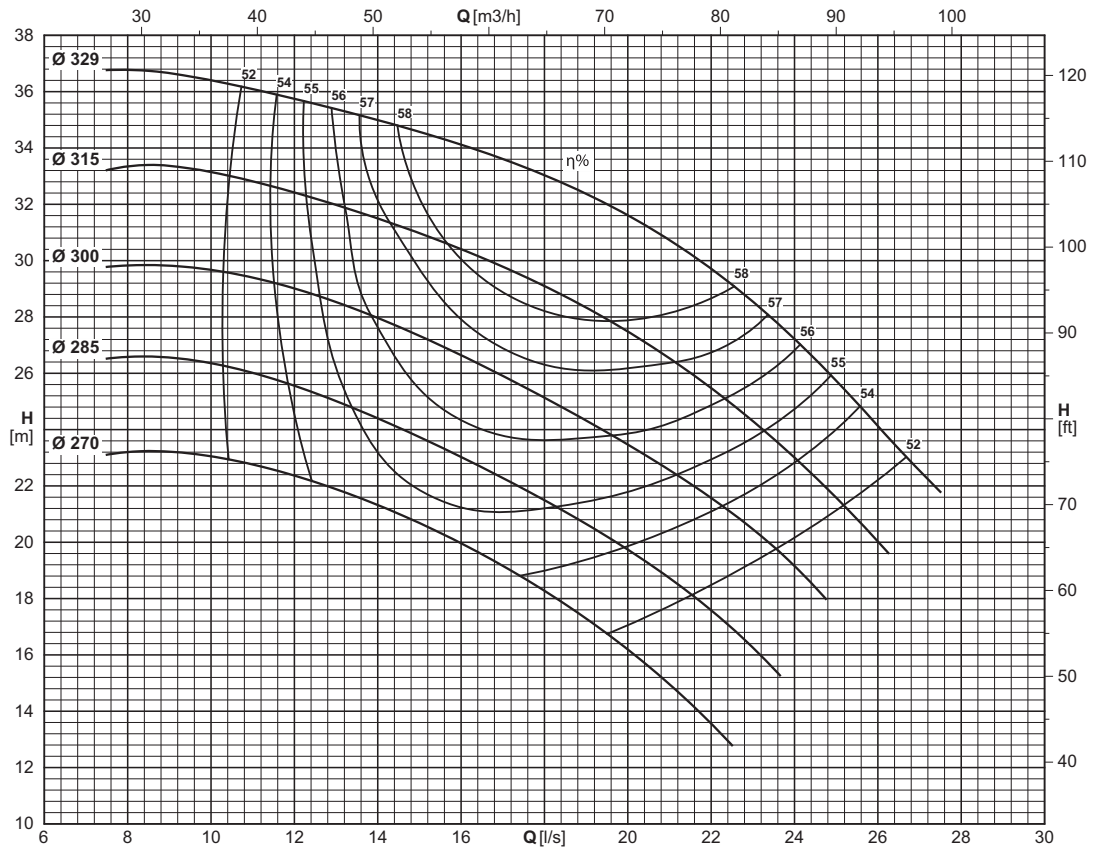

Type Type Tipo	Inlet maximum pressure (*) Pression maximale en aspiration (*) Pressione massima in aspirazione (*)	Dynamic momentum J Momentum dynamique J Momento dinamico J	
		With cast iron impellers Avec roues en fonte Con giranti in ghisa	With AISI 316 impellers Avec roues en AISI 316 Con giranti in AISI 316
		J=1/4PD <sup>2</sup>	
	[bar]	[kgm <sup>2</sup> ]	[kgm <sup>2</sup> ]
NC65-315	5	0,1117506	(F) 0,127715

Construction reference standard EN733 (DIN24255)  
 (\*) Value referred to the impeller with maximum diameter.

Norme de référence construction EN733 (DIN24255)  
 (\*) Valeur se référant à la roue à ailettes avec le diamètre maximum.

Norma di riferimento costruttivo EN733 (DIN24255)  
 (\*) Valore riferito alla girante con diametro massimo.

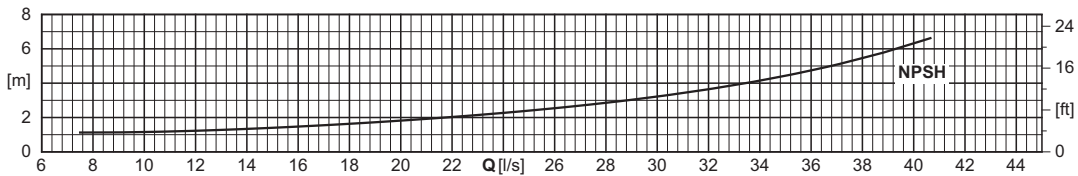
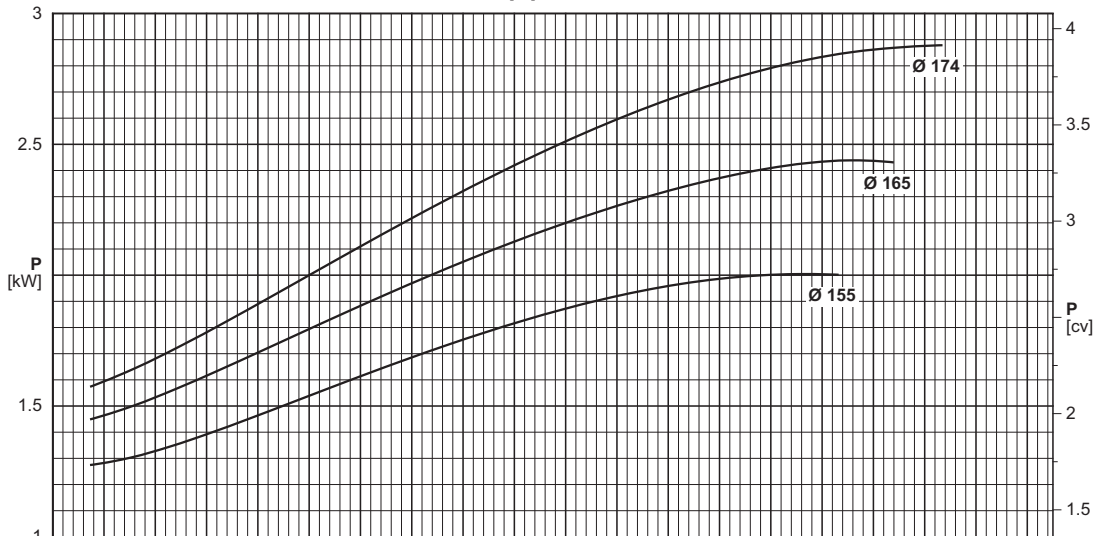
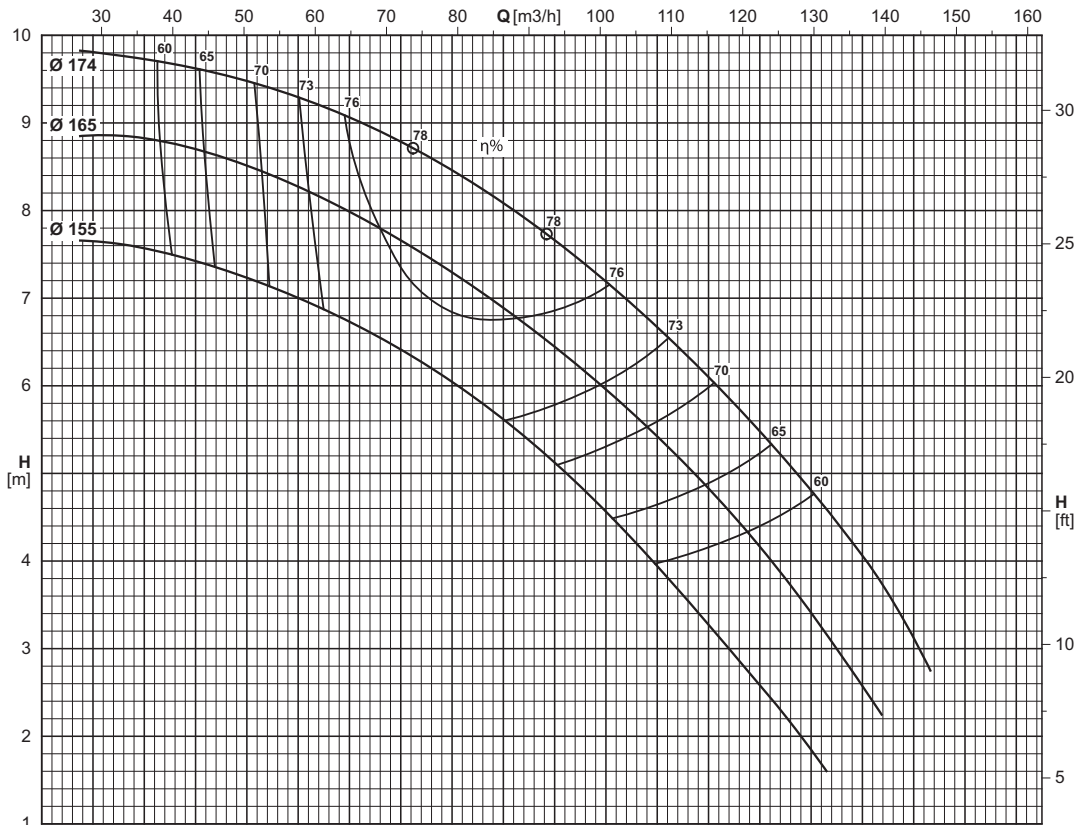

Type Type Tipo	Inlet maximum pressure (*) Pression maximale en aspiration (*) Pressione massima in aspirazione (*)	Dinamic momentum J Momentum dynamique J Momento dinamico J	
		With cast iron impellers Avec roues en fonte Con giranti in ghisa	With AISI 316 impellers Avec roues en AISI 316 Con giranti in AISI 316
		J = 1/4 PD <sup>2</sup>	
	[bar]	[kgm <sup>2</sup> ]	[kgm <sup>2</sup> ]
NC80-160	8	0,0103532	(F) 0,0118322

Construction reference standard EN733 (DIN24255)  
(\*) Value referred to the impeller with maximum diameter.

Norme de référence construction EN733 (DIN24255)  
(\*) Valeur se référant à la roue à ailettes avec le diamètre maximum.

Norma di riferimento costruttivo EN733 (DIN24255)  
(\*) Valore riferito alla girante con diametro massimo.

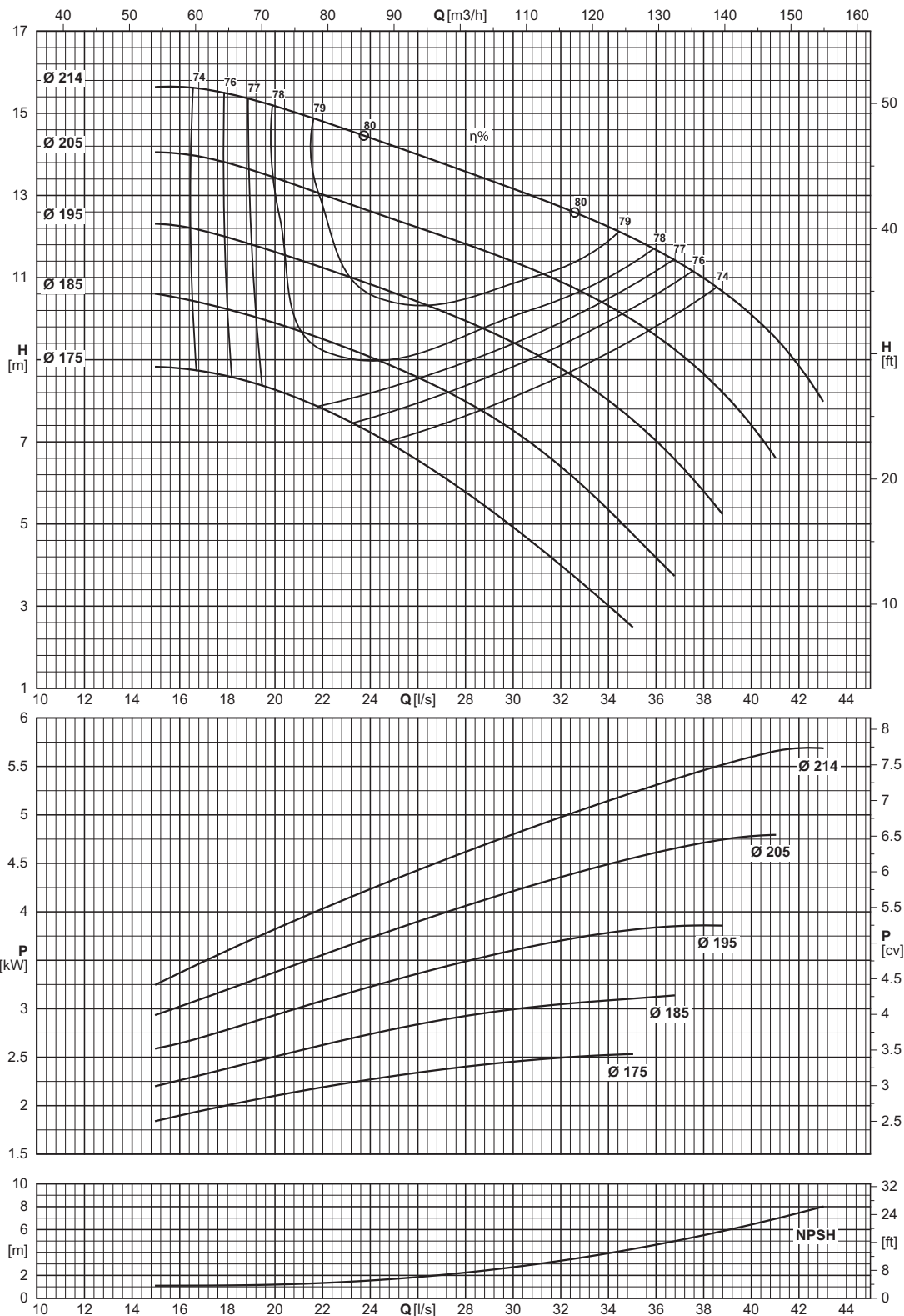

Type Type Tipo	Inlet maximum pressure (*) Pression maximale en aspiration (*) Pressione massima in aspirazione (*)	Dynamic momentum J Momentum dynamique J Momento dinamico J	
		With cast iron impellers Avec roues en fonte Con giranti in ghisa	With AISI 316 impellers Avec roues en AISI 316 Con giranti in AISI 316
		J=1/4PD²	
	[bar]	[kgm²]	[kgm²]
NC80-200	7	0,0203788	(F) 0,023329

Construction reference standard EN733 (DIN24255)  
 (\*) Value referred to the impeller with maximum diameter.

Norme de référence construction EN733 (DIN24255)  
 (\*) Valeur se référant à la roue à ailettes avec le diamètre maximum.

Norma di riferimento costruttivo EN733 (DIN24255)  
 (\*) Valore riferito alla girante con diametro massimo.

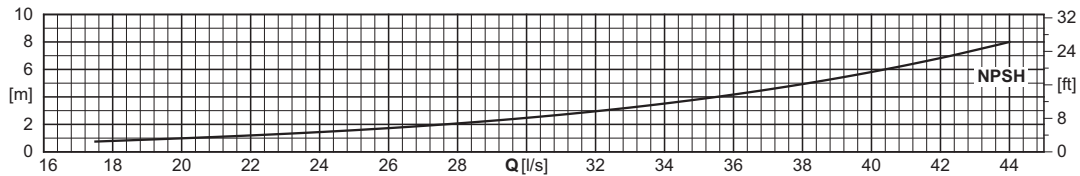
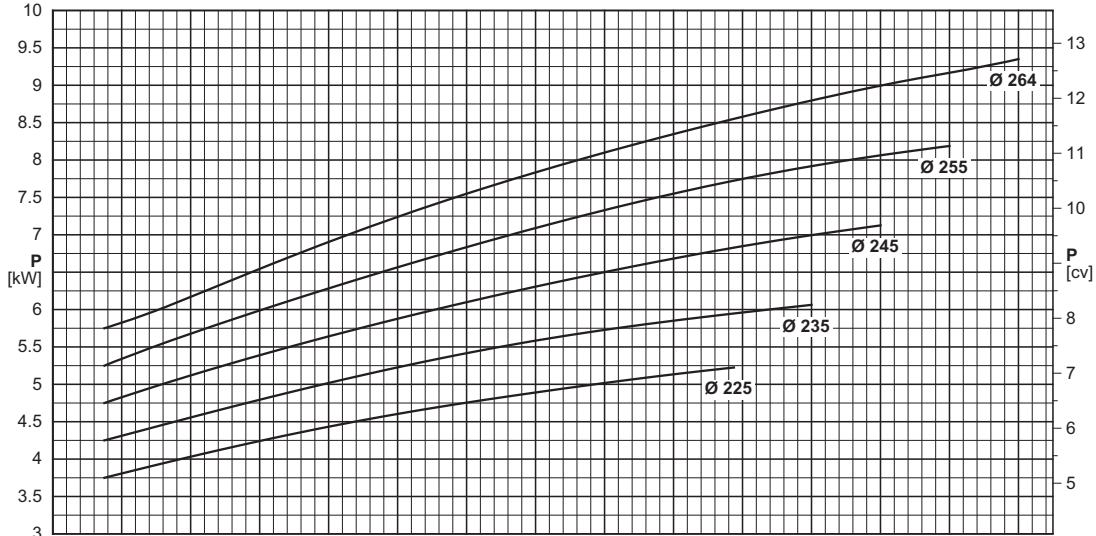
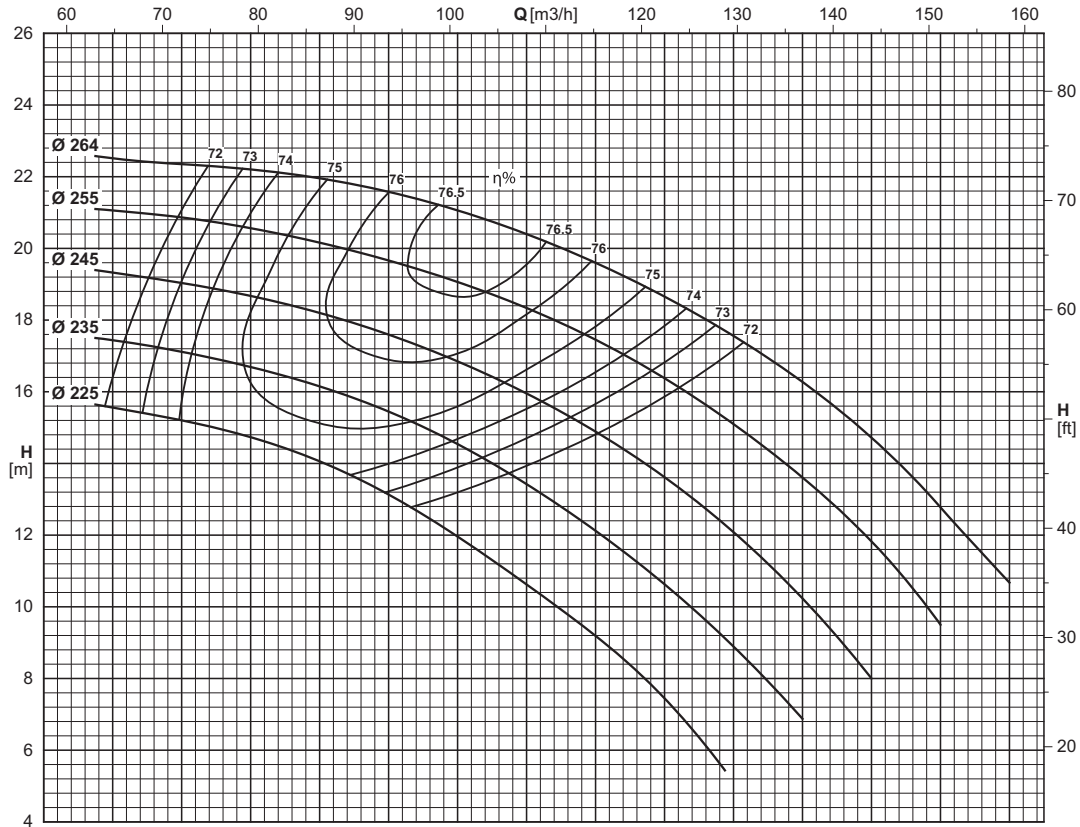

Type Type Tipo	Inlet maximum pressure (*) Pression maximale en aspiration (*) Pressione massima in aspirazione (*)	Dynamic momentum J Momentum dynamique J Momento dinamico J	
		With cast iron impellers Avec roues en fonte Con giranti in ghisa	With AISI 316 impellers Avec roues en AISI 316 Con giranti in AISI 316
		J = 1/4 PD <sup>2</sup>	
[bar]		[kgm <sup>2</sup> ]	
NC80-250	6	0,0427285	(F) 0,0488326

Construction reference standard EN733 (DIN24255)  
(\*) Value referred to the impeller with maximum diameter.

Norme de référence construction EN733 (DIN24255)  
(\*) Valeur se référant à la roue à ailettes avec le diamètre maximum.

Norma di riferimento costruttivo EN733 (DIN24255)  
(\*) Valore riferito alla girante con diametro massimo.

Operating data  
 Caracteristiques de fonctionnement  
 Caratteristiche di funzionamento

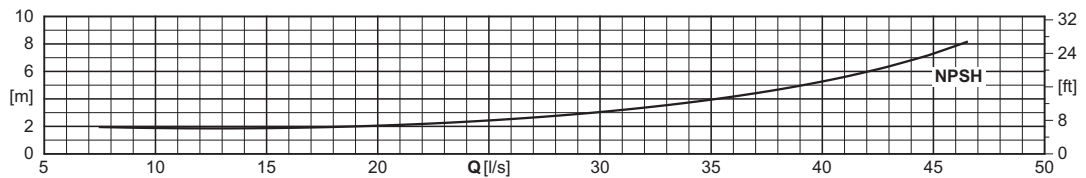
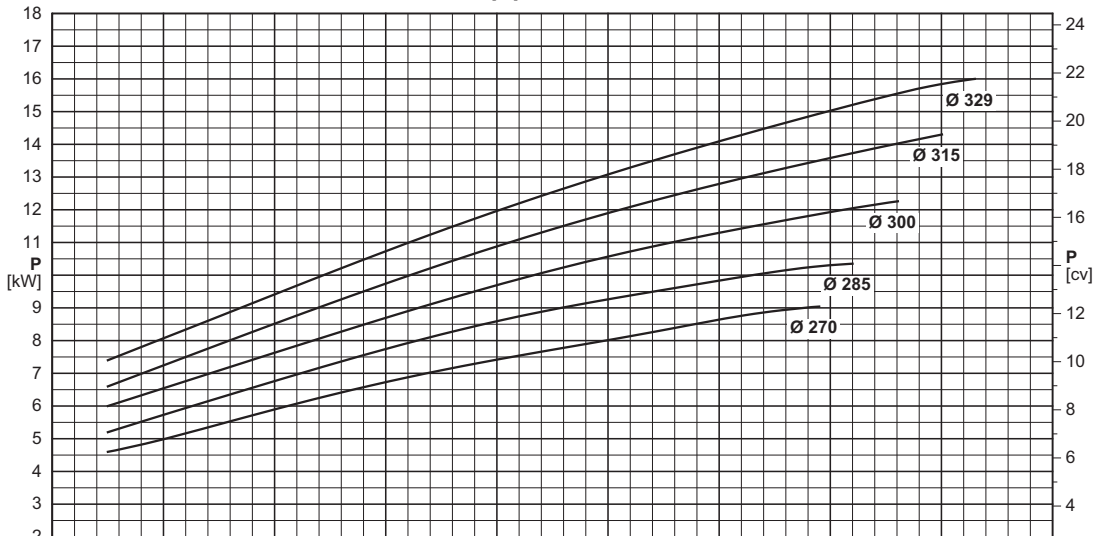
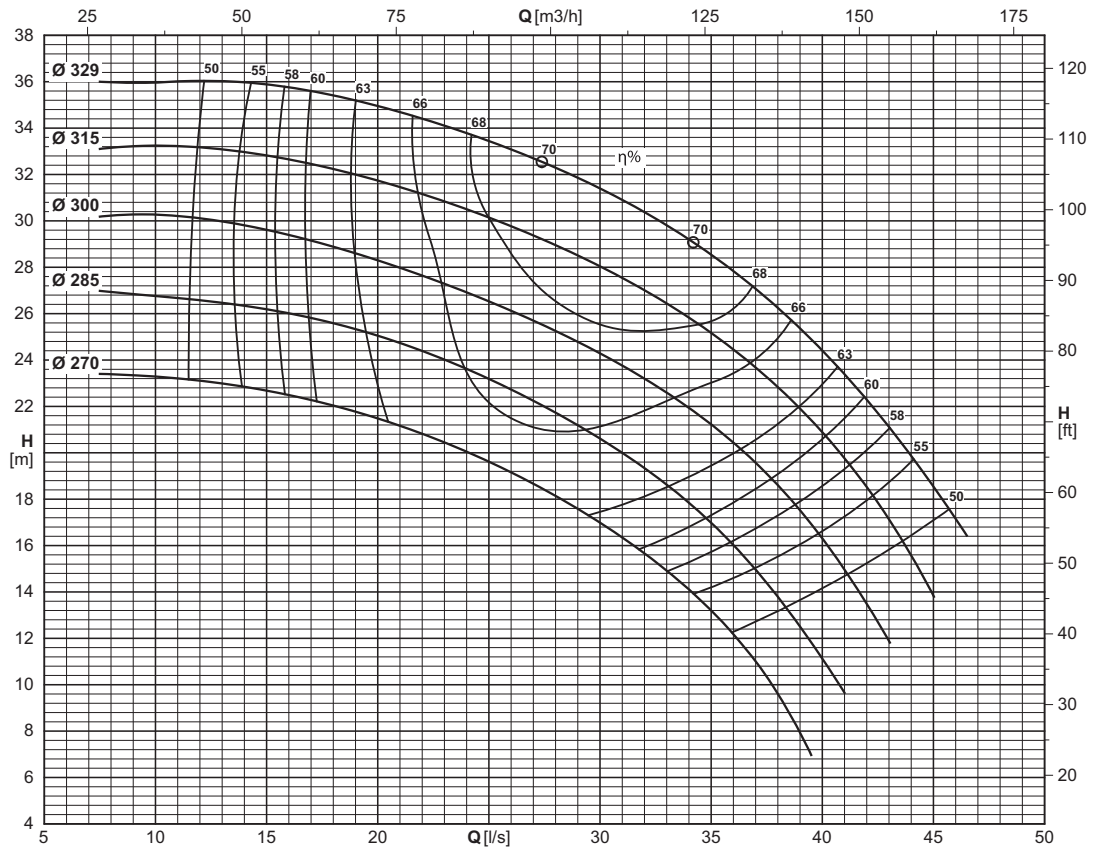

Type Type Tipo	Inlet maximum pressure (*) Pression maximale en aspiration (*) Pressione massima in aspirazione (*)	Dynamic momentum J Momentum dynamique J Momento dinamico J	
		With cast iron impellers Avec roues en fonte Con giranti in ghisa	With AISI 316 impellers Avec roues en AISI 316 Con giranti in AISI 316
		J = 1/4 PD <sup>2</sup>	
	[bar]	[kgm <sup>2</sup> ]	[kgm <sup>2</sup> ]
NC80-315	5	0,109025	(F) 0,1246

Construction reference standard EN733 (DIN24255)  
 (\*) Value referred to the impeller with maximum diameter.

Norme de référence construction EN733 (DIN24255)  
 (\*) Valeur se référant à la roue à ailettes avec le diamètre maximum.

Norma di riferimento costruttivo EN733 (DIN24255)  
 (\*) Valore riferito alla girante con diametro massimo.

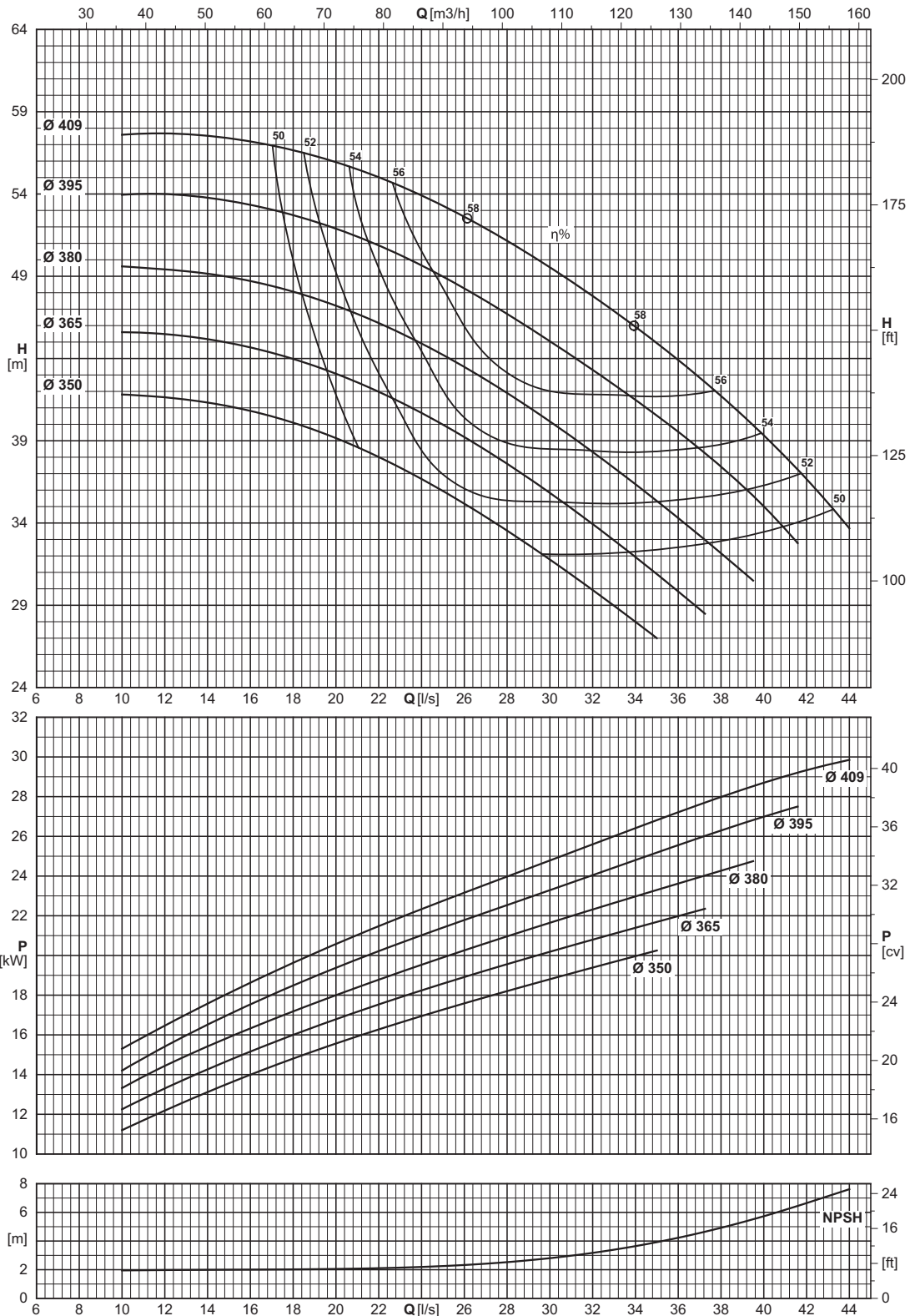

Type Type Tipo	Inlet maximum pressure (*) Pression maximale en aspiration (*) Pressione massima in aspirazione (*)	Dinamic momentum J Momentum dynamique J Momento dinamico J	
		With cast iron impellers Avec roues en fonte Con giranti in ghisa	With AISI 316 impellers Avec roues en AISI 316 Con giranti in AISI 316
		J = 1/4 PD <sup>2</sup>	
	[bar]	[kgm <sup>2</sup> ]	(F) 0,2530875
NC80-400	3	0,2214516	(F) 0,2530875

Construction reference standard EN733 (DIN24255)  
(\*) Value referred to the impeller with maximum diameter.

Norme de référence construction EN733 (DIN24255)  
(\*) Valeur se référant à la roue à ailettes avec le diamètre maximum.

Norma di riferimento costruttivo EN733 (DIN24255)  
(\*) Valore riferito alla girante con diametro massimo.

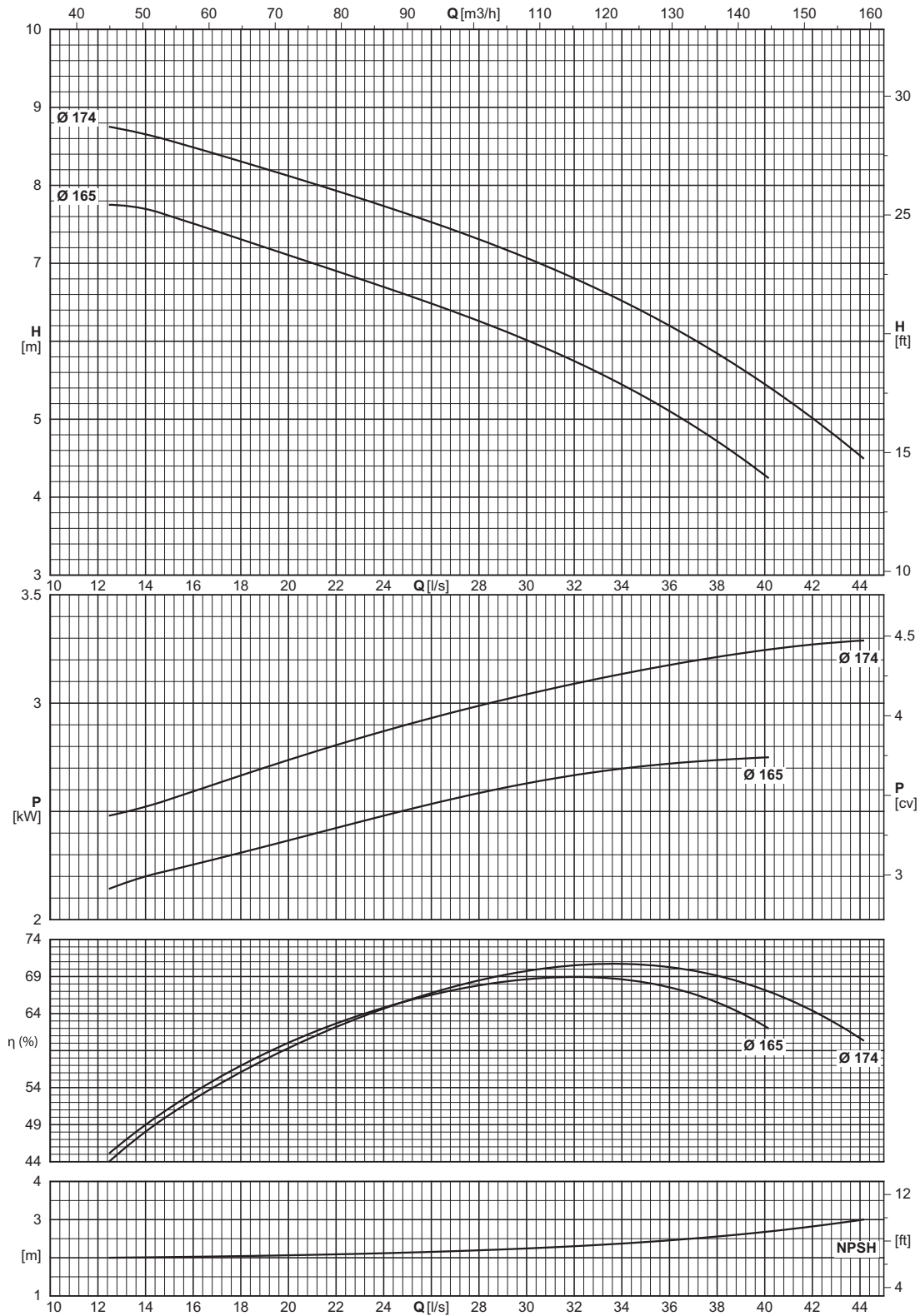

Type Type Tipo	Inlet maximum pressure (*) Pression maximale en aspiration (*) Pressione massima in aspirazione (*)	Dynamic momentum J Momentum dynamique J Momento dinamico J	
		With cast iron impellers Avec roues en fonte Con giranti in ghisa	With AISI 316 impellers Avec roues en AISI 316 Con giranti in AISI 316
		$J = \frac{1}{4}PD^2$	
	[bar]	[kgm <sup>2</sup> ]	
NC100-160	8	0,0116475	(F) 0,0133114

Construction reference standard EN733 (DIN24255)  
 (\*) Value referred to the impeller with maximum diameter.

Norme de référence construction EN733 (DIN24255)  
 (\*) Valeur se référant à la roue à ailettes avec le diamètre maximum.

Norma di riferimento costruttivo EN733 (DIN24255)  
 (\*) Valore riferito alla girante con diametro massimo.

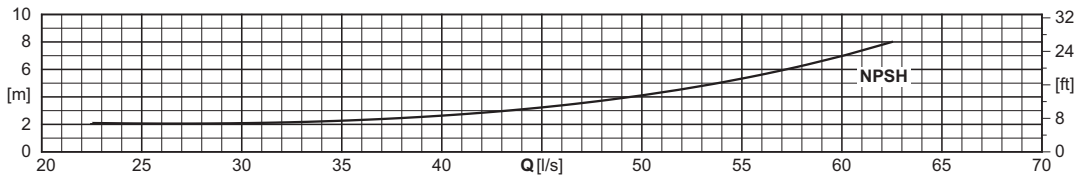
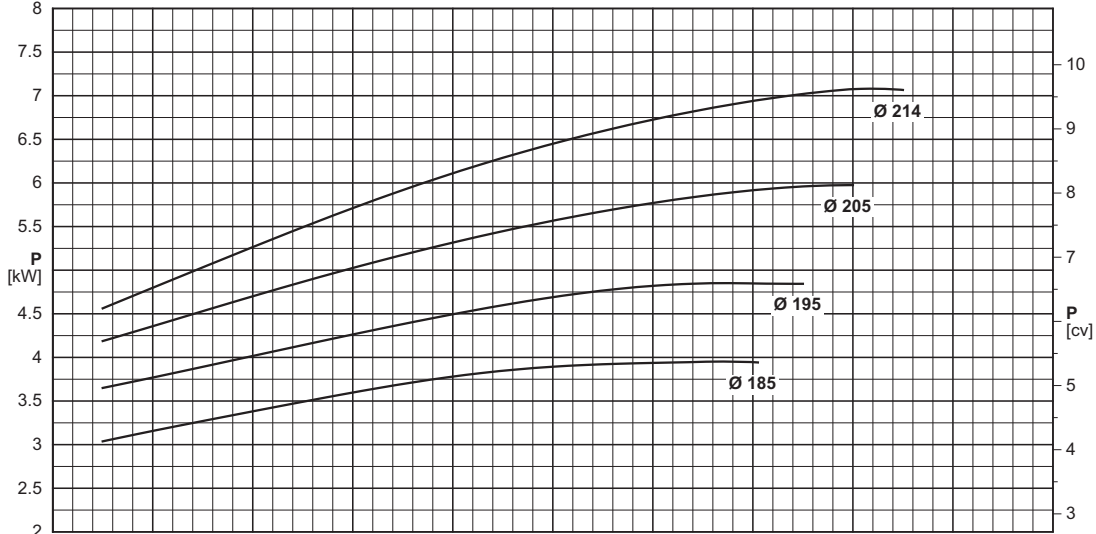
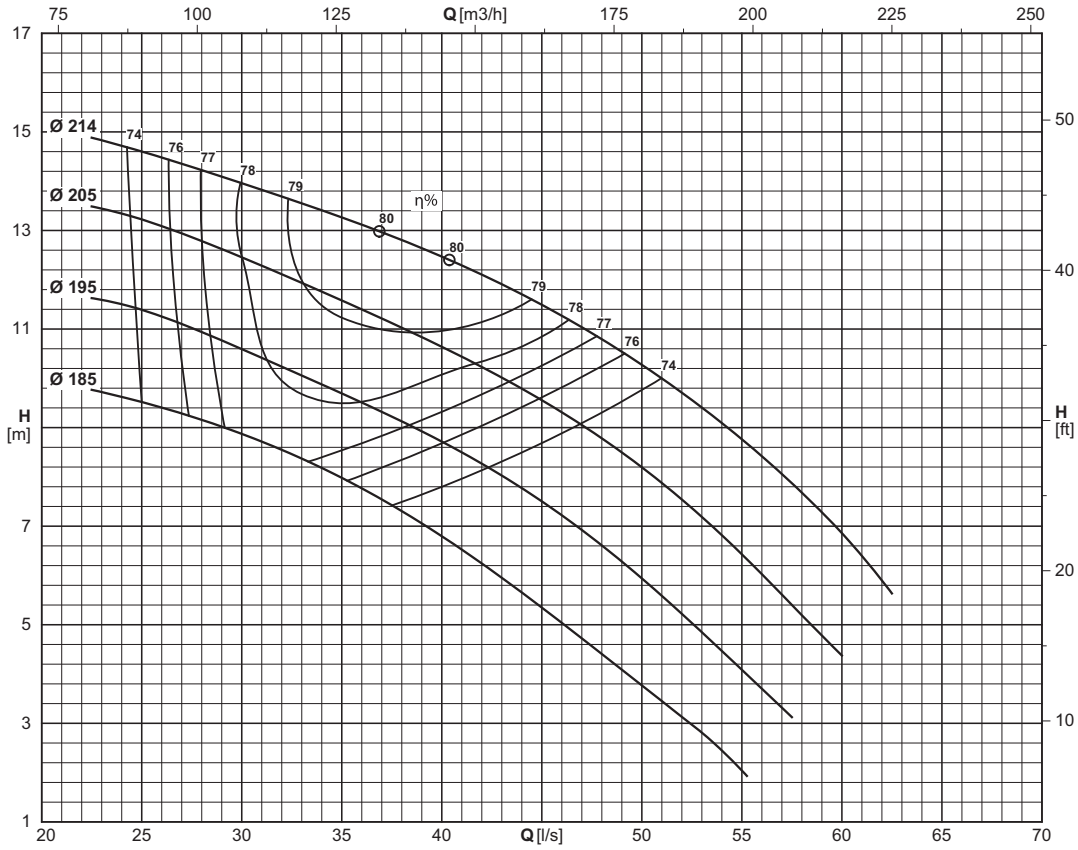

Type Type Tipo	Inlet maximum pressure (*) Pression maximale en aspiration (*) Pressione massima in aspirazione (*)	Dynamic momentum J Momentum dynamique J Momento dinamico J	
		With cast iron impellers Avec roues en fonte Con giranti in ghisa	With AISI 316 impellers Avec roues en AISI 316 Con giranti in AISI 316
		J = 1/4 PD <sup>2</sup>	
[bar]		[kgm <sup>2</sup> ]	
NC100-200	7	0,0247456	(F) 0,0282807

Construction reference standard EN733 (DIN24255)  
(\*) Value referred to the impeller with maximum diameter.

Norme de référence construction EN733 (DIN24255)  
(\*) Valeur se référant à la roue à ailettes avec le diamètre maximum.

Norma di riferimento costruttivo EN733 (DIN24255)  
(\*) Valore riferito alla girante con diametro massimo.



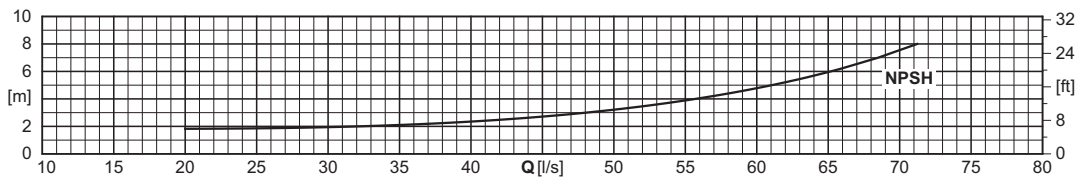
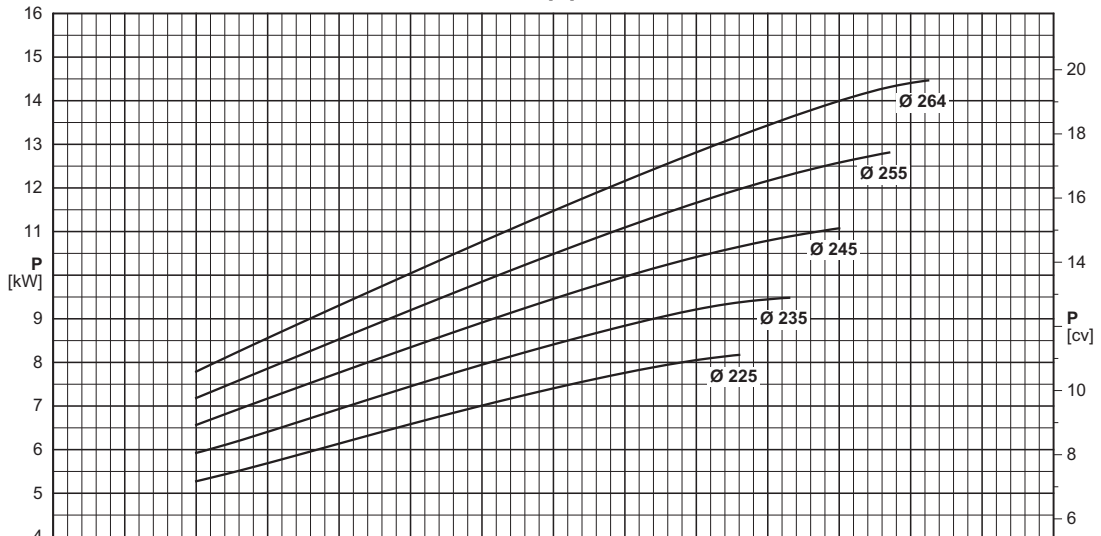
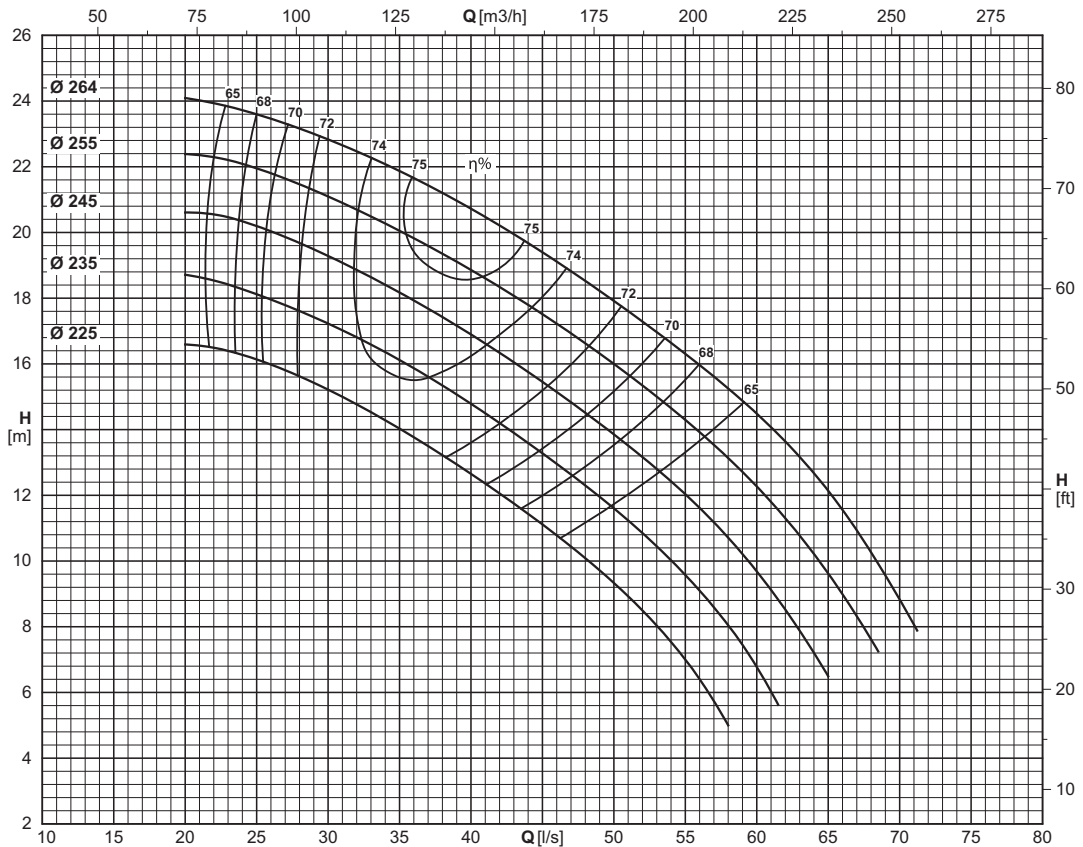

Type Type Tipo	Inlet maximum pressure (*) Pression maximale en aspiration (*) Pressione massima in aspirazione (*)	Dynamic momentum J Momentum dynamique J Momento dinamico J	
		With cast iron impellers Avec roues en fonte Con giranti in ghisa	With AISI 316 impellers Avec roues en AISI 316 Con giranti in AISI 316
		J=1/4PD²	
[bar]		[kgm²]	
NC100-250	6	0,057265	(F) 0,0654457

Construction reference standard EN733 (DIN24255)  
 (\*) Value referred to the impeller with maximum diameter.

Norme de référence construction EN733 (DIN24255)  
 (\*) Valeur se référant à la roue à ailettes avec le diamètre maximum.

Norma di riferimento costruttivo EN733 (DIN24255)  
 (\*) Valore riferito alla girante con diametro massimo.

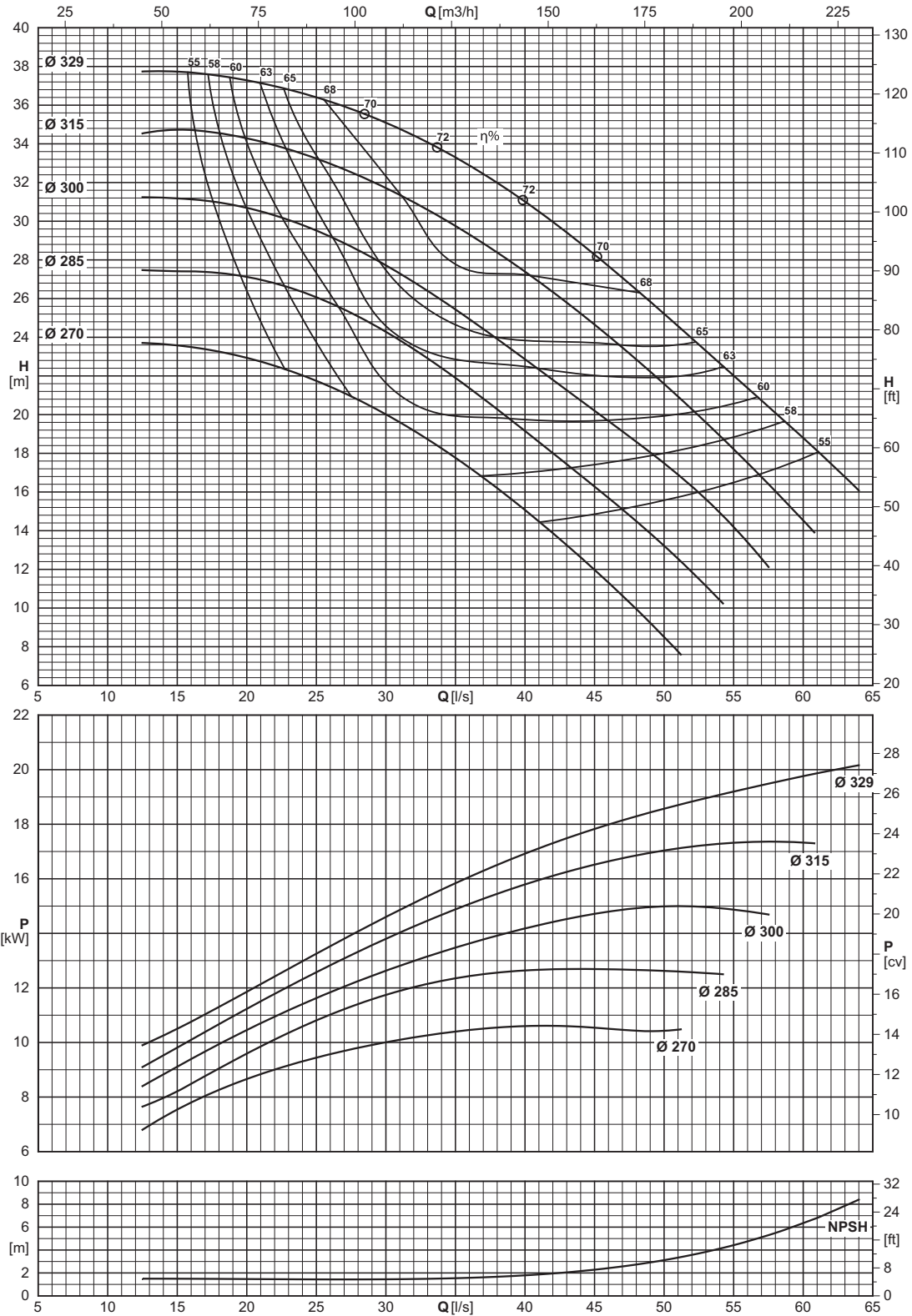

Type Type Tipo	Inlet maximum pressure (*) Pression maximale en aspiration (*) Pressione massima in aspirazione (*)	Dinamic momentum J Momentum dynamique J Momento dinamico J	
		With cast iron impellers Avec roues en fonte Con giranti in ghisa	With AISI 316 impellers Avec roues en AISI 316 Con giranti in AISI 316
		J=1/4PD²	
	[bar]	[kgm²]	[kgm²]
NC100-315	5	0,1567234	(F) 0,1791125

Construction reference standard EN733 (DIN24255)  
(\*) Value referred to the impeller with maximum diameter.

Norme de référence construction EN733 (DIN24255)  
(\*) Valeur se référant à la roue à ailettes avec le diamètre maximum.

Norma di riferimento costruttivo EN733 (DIN24255)  
(\*) Valore riferito alla girante con diametro massimo.

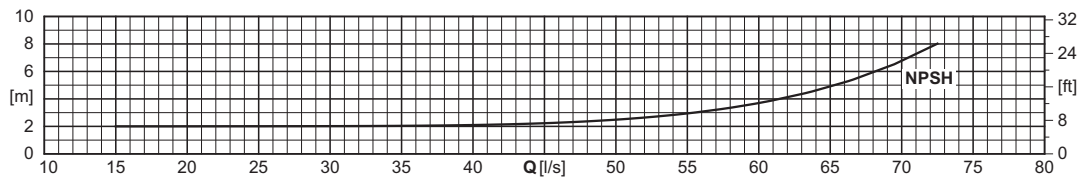
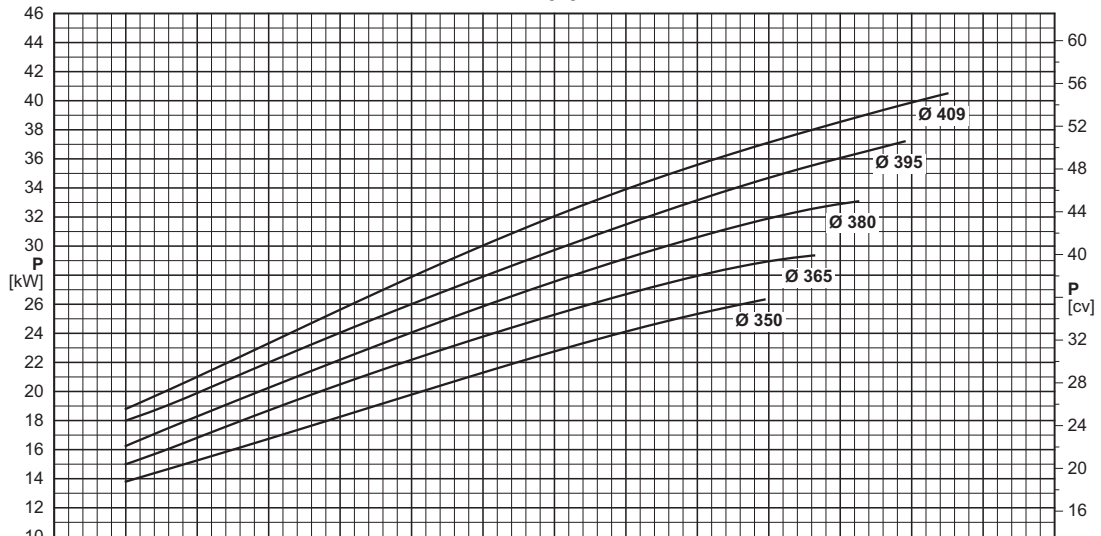
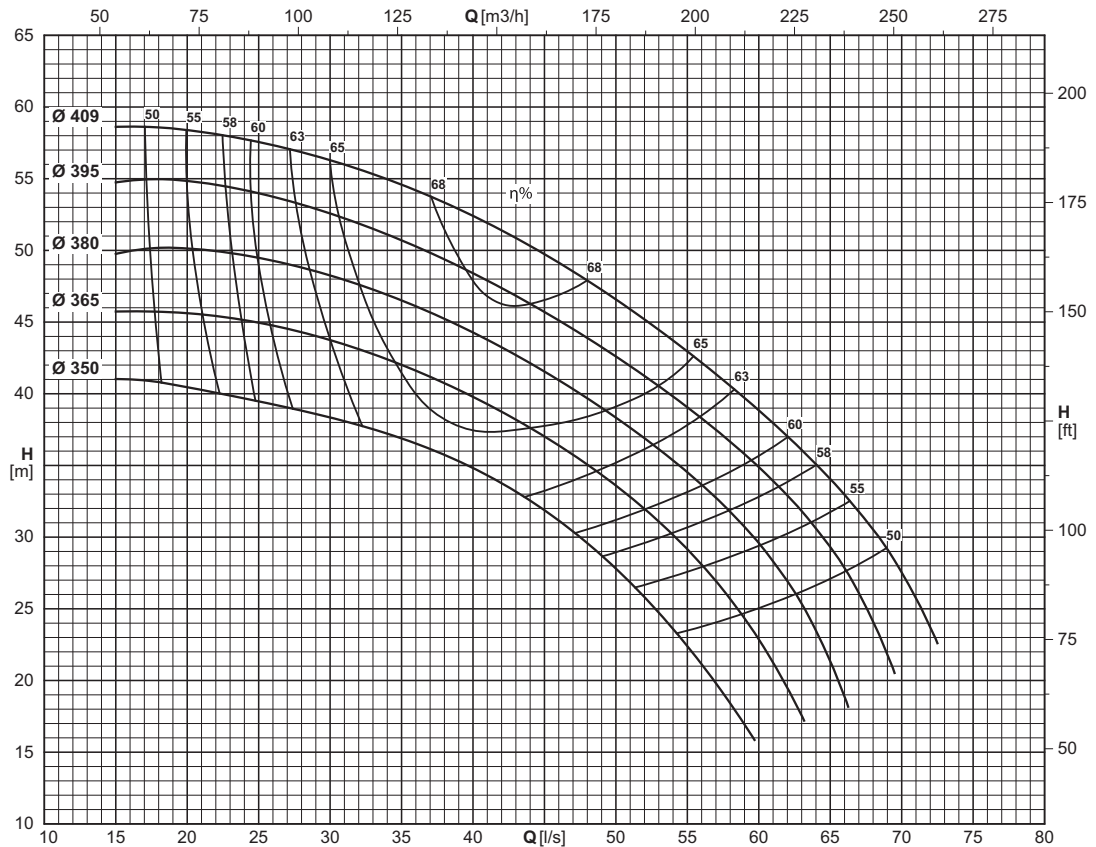

Type Type Tipo	Inlet maximum pressure (*) Pression maximale en aspiration (*) Pressione massima in aspirazione (*)	Dynamic momentum J Momentum dynamique J Momento dinamico J	
		With cast iron impellers Avec roues en fonte Con giranti in ghisa	With AISI 316 impellers Avec roues en AISI 316 Con giranti in AISI 316
		J=1/4PD²	
	[bar]	[kgm²]	[kgm²]
NC100-400	3	0,3058141	(F) 0,3495018

Construction reference standard EN733 (DIN24255)  
 (\*) Value referred to the impeller with maximum diameter.

Norme de référence construction EN733 (DIN24255)  
 (\*) Valeur se référant à la roue à ailettes avec le diamètre maximum.

Norma di riferimento costruttivo EN733 (DIN24255)  
 (\*) Valore riferito alla girante con diametro massimo.

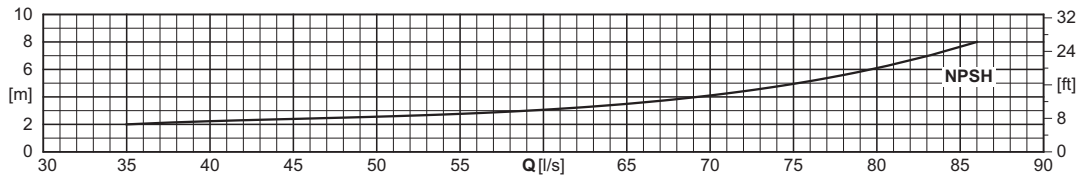
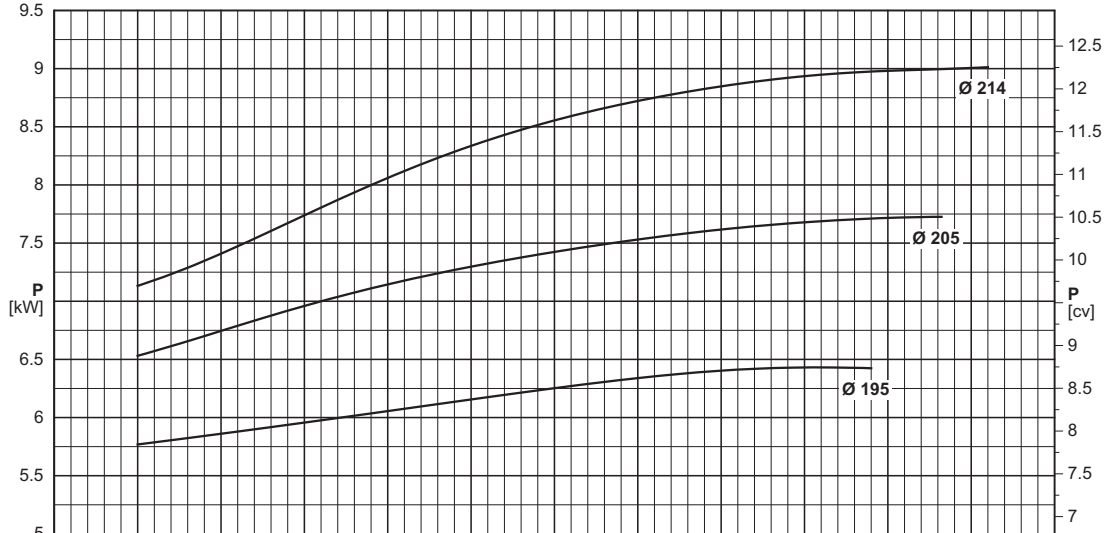
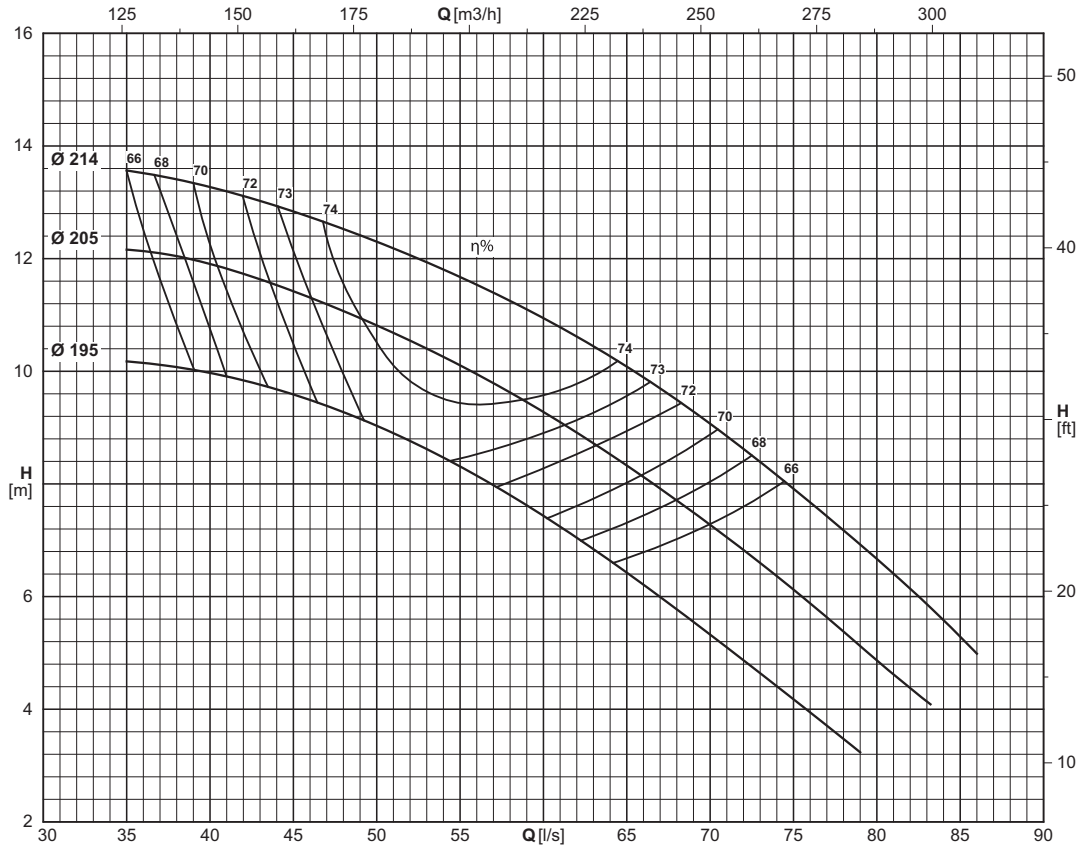

Type Type Tipo	Inlet maximum pressure (*) Pression maximale en aspiration (*) Pressione massima in aspirazione (*)	Dynamic momentum J Momentum dynamique J Momento dinamico J	
		With cast iron impellers Avec roues en fonte Con giranti in ghisa	With AISI 316 impellers Avec roues en AISI 316 Con giranti in AISI 316
		J = 1/4 PD <sup>2</sup>	
[bar]		[kgm <sup>2</sup> ]	
NC125-200	7	0,0291125	(F) 0,0332714

Construction reference standard EN733 (DIN24255)  
(\*) Value referred to the impeller with maximum diameter.

Norme de référence construction EN733 (DIN24255)  
(\*) Valeur se référant à la roue à ailettes avec le diamètre maximum.

Norma di riferimento costruttivo EN733 (DIN24255)  
(\*) Valore riferito alla girante con diametro massimo.

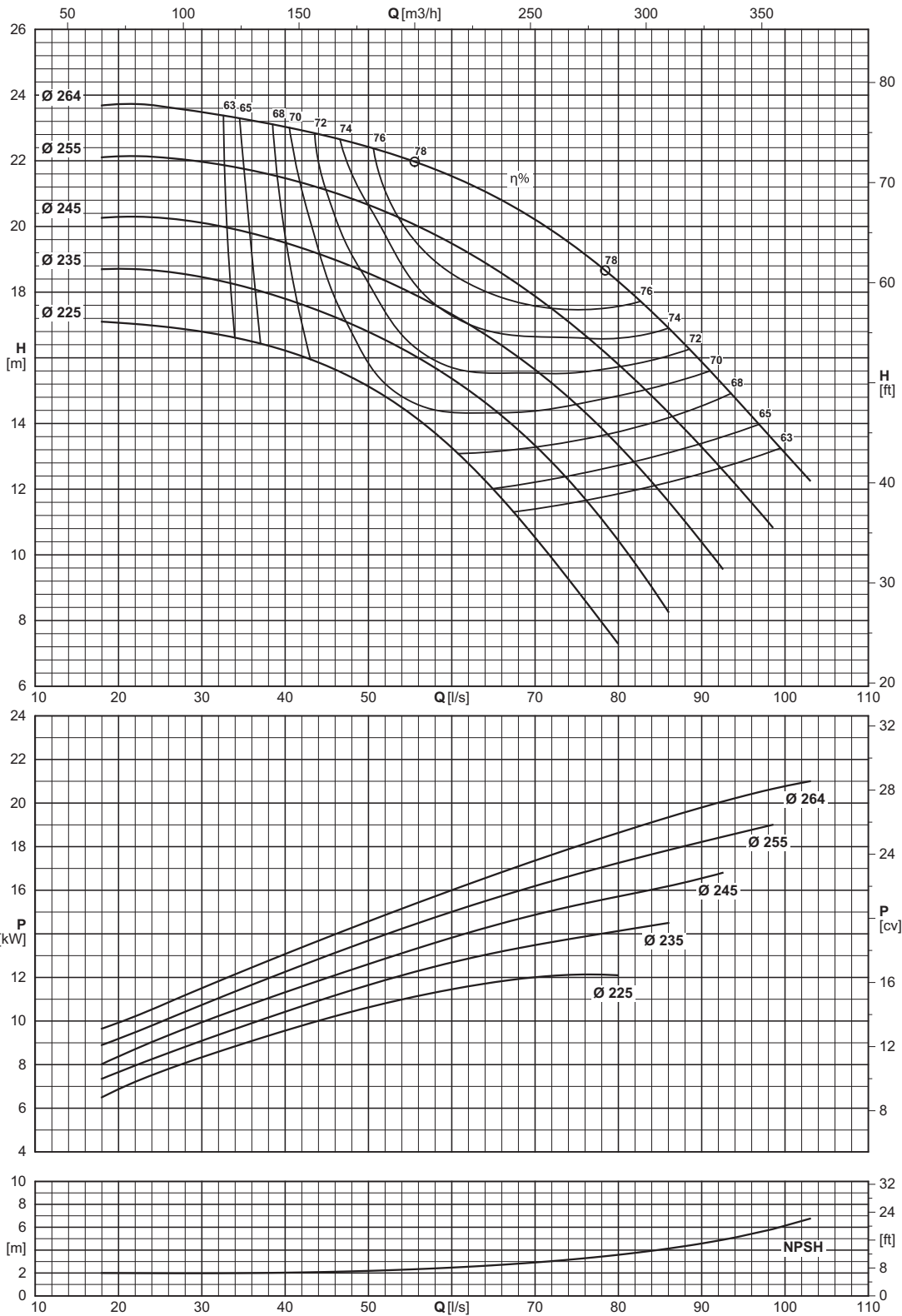

Type Type Tipo	Inlet maximum pressure (*) Pression maximale en aspiration (*) Pressione massima in aspirazione (*)	Dynamic momentum J Momentum dynamique J Momento dinamico J	
		With cast iron impellers Avec roues en fonte Con giranti in ghisa	With AISI 316 impellers Avec roues en AISI 316 Con giranti in AISI 316
		J=1/4PD²	
	[bar]	[kgm²]	[kgm²]
NC125-250	6	0,0660750	(F) 0,0755143

Construction reference standard EN733 (DIN24255)  
 (\*) Value referred to the impeller with maximum diameter.

Norme de référence construction EN733 (DIN24255)  
 (\*) Valeur se référant à la roue à ailettes avec le diamètre maximum.

Norma di riferimento costruttivo EN733 (DIN24255)  
 (\*) Valore riferito alla girante con diametro massimo.

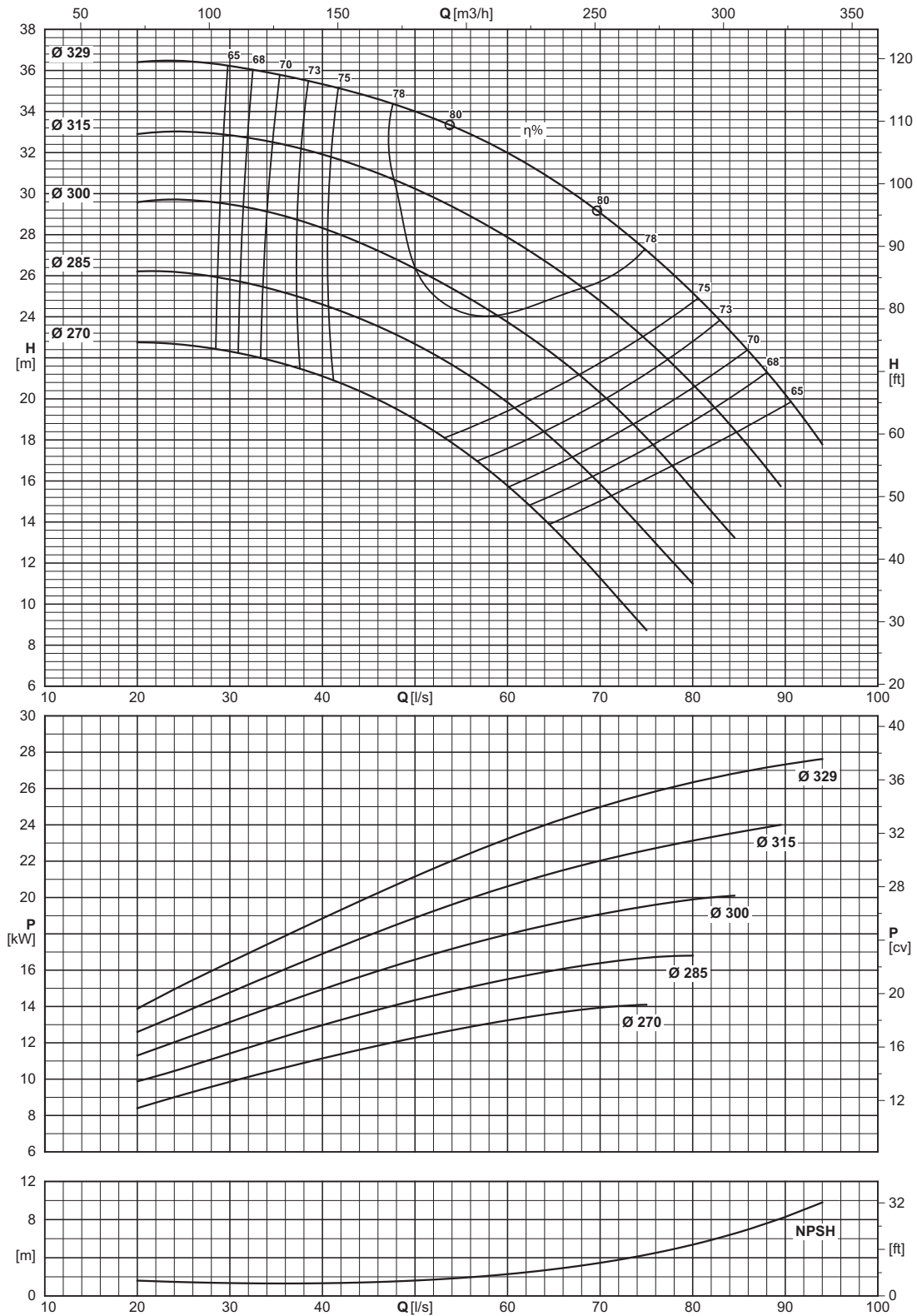

Type Type Tipo	Inlet maximum pressure (*) Pression maximale en aspiration (*) Pressione massima in aspirazione (*)	Dinamic momentum J Momentum dynamique J Momento dinamico J	
		With cast iron impellers Avec roues en fonte Con giranti in ghisa	With AISI 316 impellers Avec roues en AISI 316 Con giranti in AISI 316
		J = 1/4 PD <sup>2</sup>	
[bar]		[kgm <sup>2</sup> ]	
NC125-315	5	0,1782381	(F) 0,2037007

Construction reference standard EN733 (DIN24255)  
 (\*) Value referred to the impeller with maximum diameter.

Norme de référence construction EN733 (DIN24255)  
 (\*) Valeur se référant à la roue à ailettes avec le diamètre maximum.

Norma di riferimento costruttivo EN733 (DIN24255)  
 (\*) Valore riferito alla girante con diametro massimo.

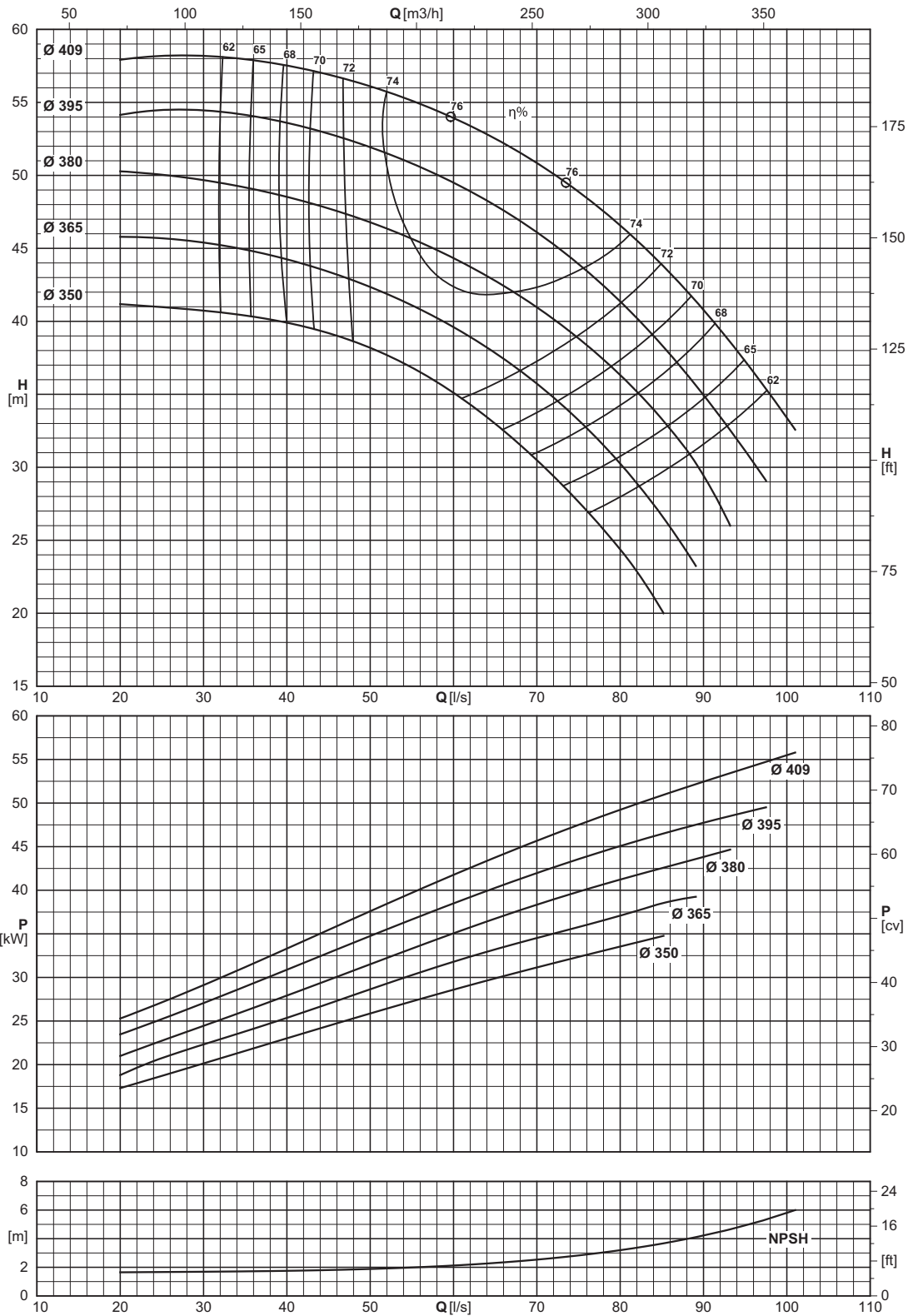

Type Type Tipo	Inlet maximum pressure (*) Pression maximale en aspiration (*) Pressione massima in aspirazione (*)	Dynamic momentum J Momentum dynamique J Momento dinamico J	
		With cast iron impellers Avec roues en fonte Con giranti in ghisa	With AISI 316 impellers Avec roues en AISI 316 Con giranti in AISI 316
		J=1/4PD <sup>2</sup>	
	[bar]	[kgm <sup>2</sup> ]	[kgm <sup>2</sup> ]
NC125-400	3	0,2636328	(F) 0,3012946

Construction reference standard EN733 (DIN24255)  
 (\*) Value referred to the impeller with maximum diameter.

Norme de référence construction EN733 (DIN24255)  
 (\*) Valeur se référant à la roue à ailettes avec le diamètre maximum.

Norma di riferimento costruttivo EN733 (DIN24255)  
 (\*) Valore riferito alla girante con diametro massimo.

# NCH 125-400

1450 n [min<sup>-1</sup>]

**caprari**

Operating data  
Caracteristiques de fonctionnement  
Caratteristiche di funzionamento

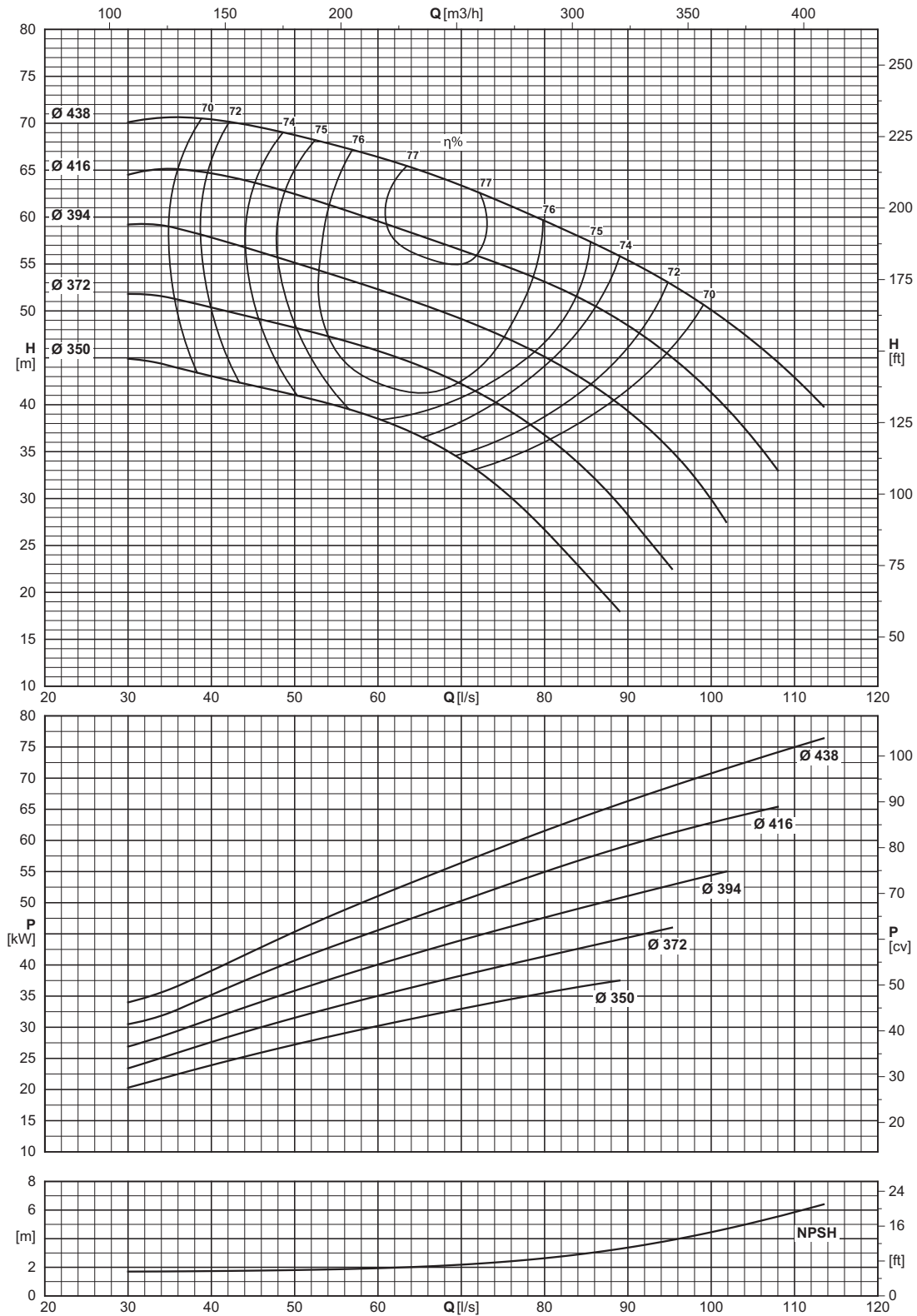

Type Type Tipo	Inlet maximum pressure (*) Pression maximale en aspiration (*) Pressione massima in aspirazione (*)	Dynamic momentum J Momentum dynamique J Momento dinamico J	
		With cast iron impellers Avec roues en fonte Con giranti in ghisa	With AISI 316 impellers Avec roues en AISI 316 Con giranti in AISI 316
		J = 1/4 PD <sup>2</sup>	
	[bar]	[kgm <sup>2</sup> ]	[kgm <sup>2</sup> ]
NCH125-400	2.5	0	(F) 0

(\*) Value referred to the impeller with maximum diameter.

(\*) Valeur se référant à la roue à ailettes avec le diamètre maximum. (\*) Valore riferito alla girante con diametro massimo.



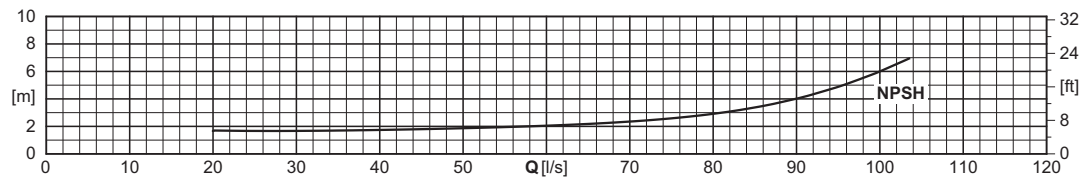
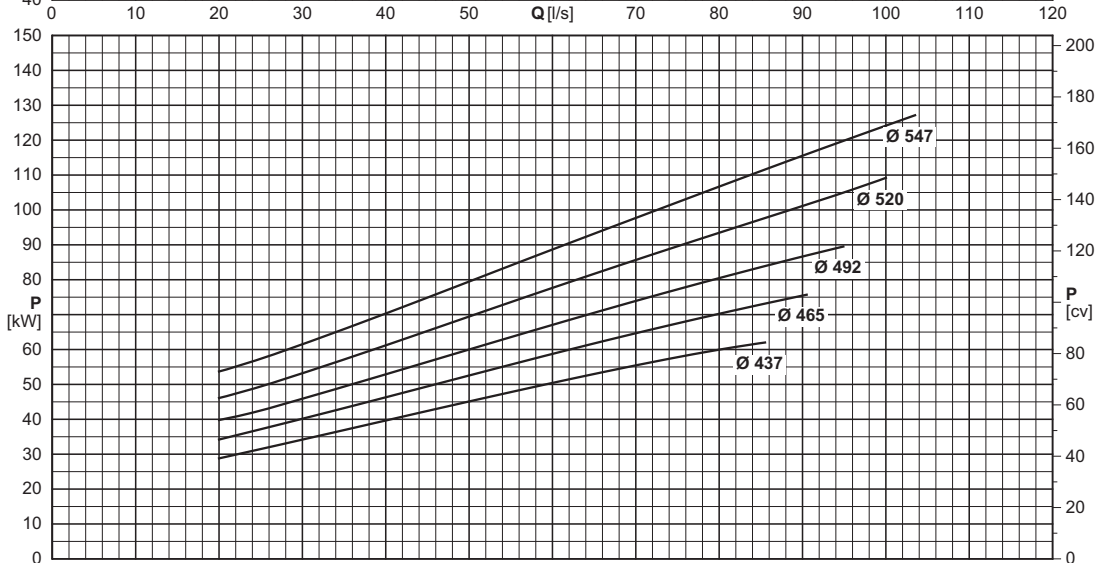
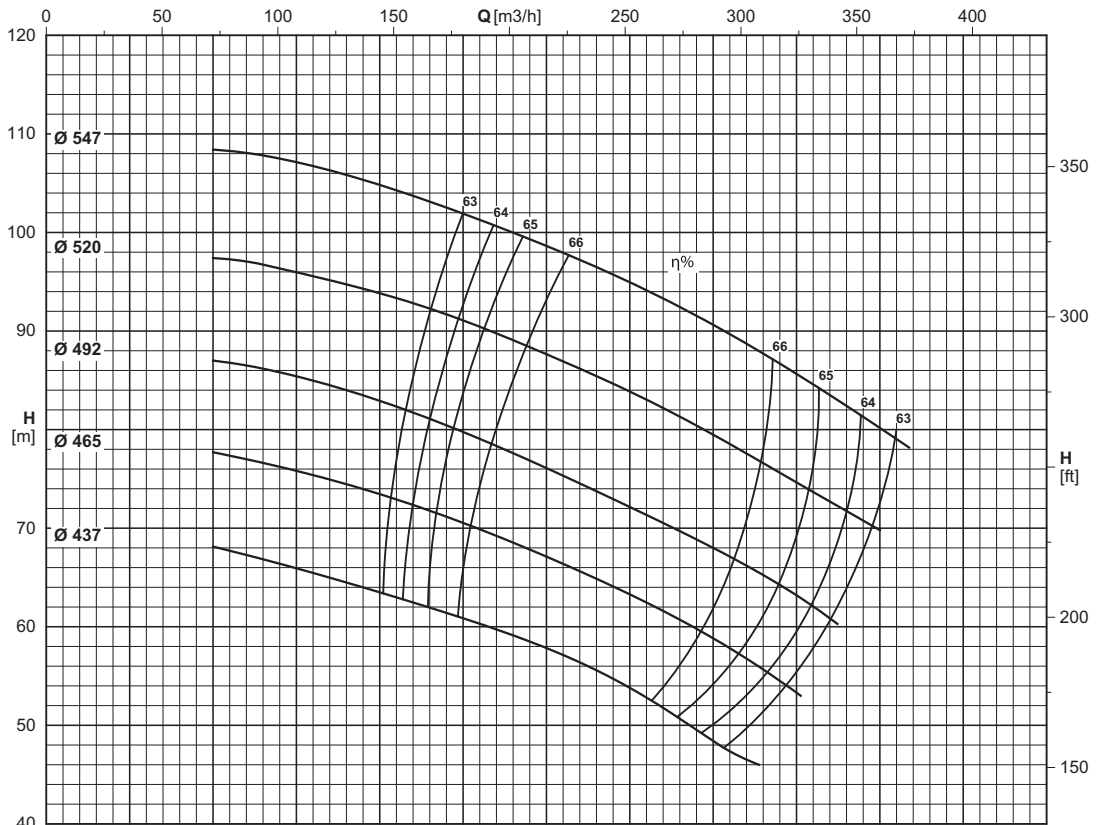

Type Type Tipo	Inlet maximum pressure (*) Pression maximale en aspiration (*) Pressione massima in aspirazione (*)	Dynamic momentum J Momentum dynamique J Momento dinamico J	
		With cast iron impellers Avec roues en fonte Con giranti in ghisa	With AISI 316 impellers Avec roues en AISI 316 Con giranti in AISI 316
		$J = \frac{1}{2}PD^2$	
[bar]		[kgm <sup>2</sup> ]	
NCH125-500	0	0	(F) 0

(\*) Value referred to the impeller with maximum diameter.

(\*) Valeur se référant à la roue à ailettes avec le diamètre maximum. (\*) Valore riferito alla girante con diametro massimo.

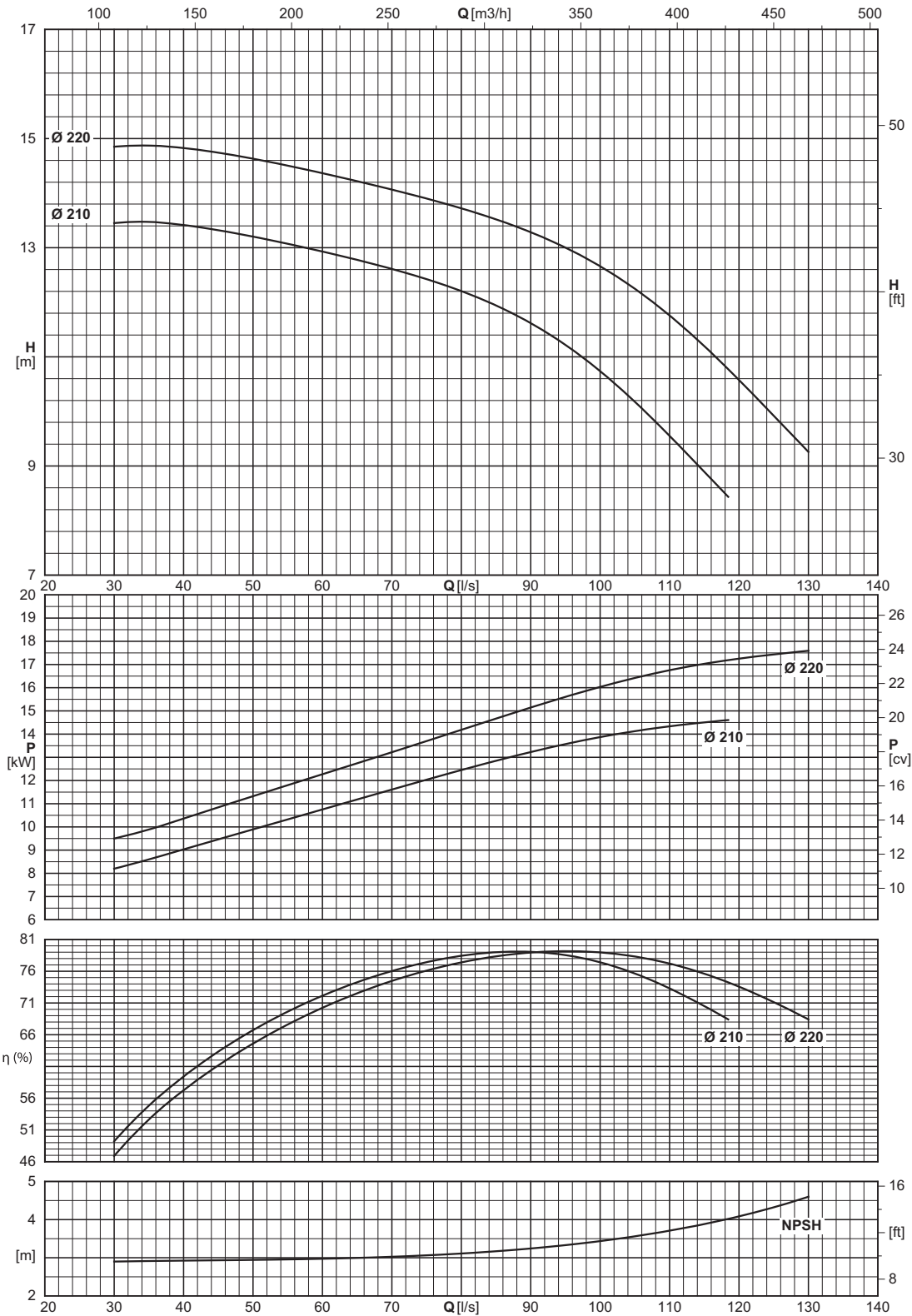

Type Type Tipo	Inlet maximum pressure (*) Pression maximale en aspiration (*) Pressione massima in aspirazione (*)	Dynamic momentum J Momentum dynamique J Momento dinamico J	
		With cast iron impellers Avec roues en fonte Con giranti in ghisa	With AISI 316 impellers Avec roues en AISI 316 Con giranti in AISI 316
		J = 1/4 PD <sup>2</sup>	
[bar]		[kgm <sup>2</sup> ]	
NC150-200	7	0,05916	(F) 0,0676114

Construction reference standard EN733 (DIN24255)  
(\*) Value referred to the impeller with maximum diameter.

Norme de référence construction EN733 (DIN24255)  
(\*) Valeur se référant à la roue à ailettes avec le diamètre maximum.

Norma di riferimento costruttivo EN733 (DIN24255)  
(\*) Valore riferito alla girante con diametro massimo.

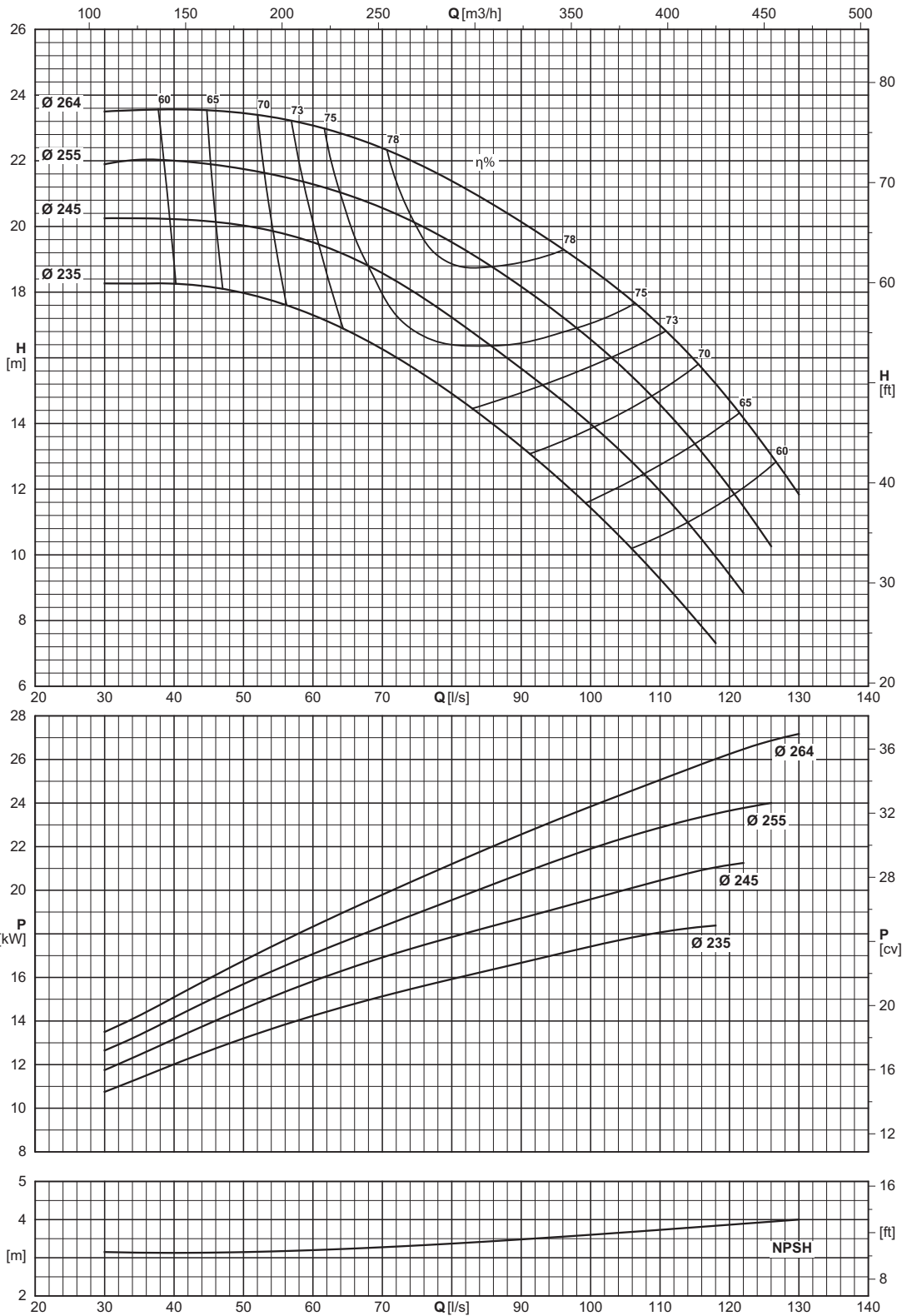

Type Type Tipo	Inlet maximum pressure (*) Pression maximale en aspiration (*) Pressione massima in aspirazione (*)	Dynamic momentum J Momentum dynamique J Momento dinamico J	
		With cast iron impellers Avec roues en fonte Con giranti in ghisa	With AISI 316 impellers Avec roues en AISI 316 Con giranti in AISI 316
		J=¼PD²	
	[bar]	[kgm²]	[kgm²]
NC150-250	6	0,0755863	(F) 0,0863843

Construction reference standard EN733 (DIN24255)  
 (\*) Value referred to the impeller with maximum diameter.

Norme de référence construction EN733 (DIN24255)  
 (\*) Valeur se référant à la roue à ailettes avec le diamètre maximum.

Norma di riferimento costruttivo EN733 (DIN24255)  
 (\*) Valore riferito alla girante con diametro massimo.

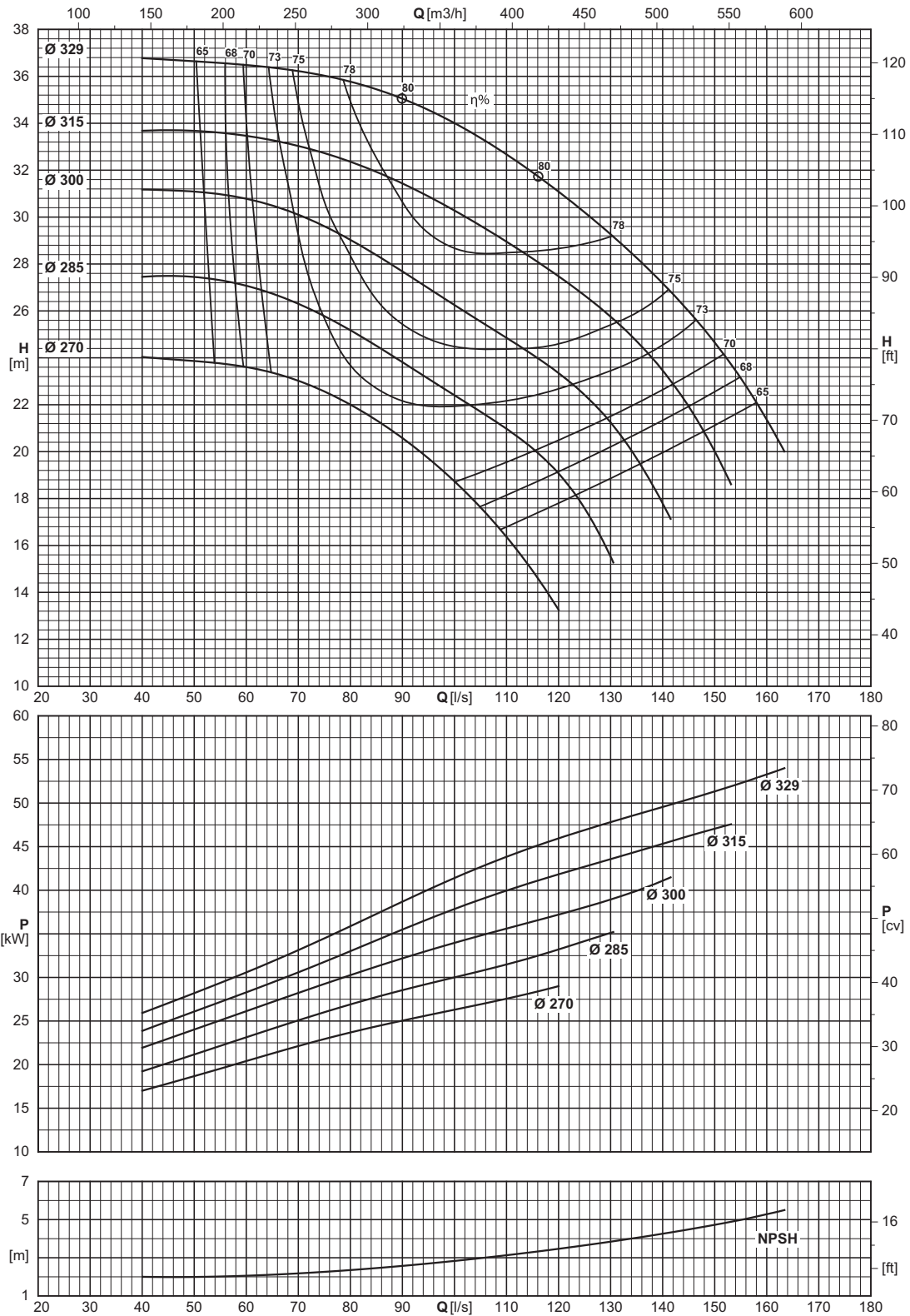

Type Type Tipo	Inlet maximum pressure (*) Pression maximale en aspiration (*) Pressione massima in aspirazione (*)	Dynamic momentum J Momentum dynamique J Momento dinamico J	
		With cast iron impellers Avec roues en fonte Con giranti in ghisa	With AISI 316 impellers Avec roues en AISI 316 Con giranti in AISI 316
		J = 1/4 PD <sup>2</sup>	
	[bar]	[kgm <sup>2</sup> ]	
NC150-315	5	0,153559	(F) 0,175496

Construction reference standard EN733 (DIN24255)  
(\*) Value referred to the impeller with maximum diameter.

Norme de référence construction EN733 (DIN24255)  
(\*) Valeur se référant à la roue à ailettes avec le diamètre maximum.

Norma di riferimento costruttivo EN733 (DIN24255)  
(\*) Valore riferito alla girante con diametro massimo.

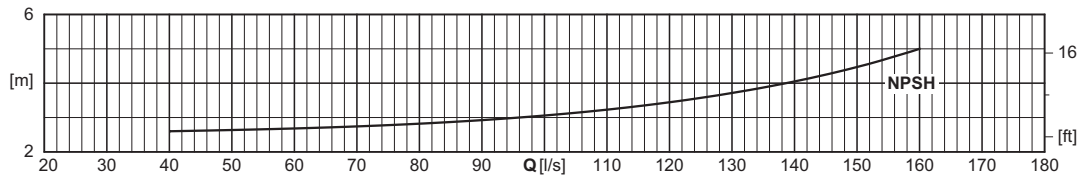
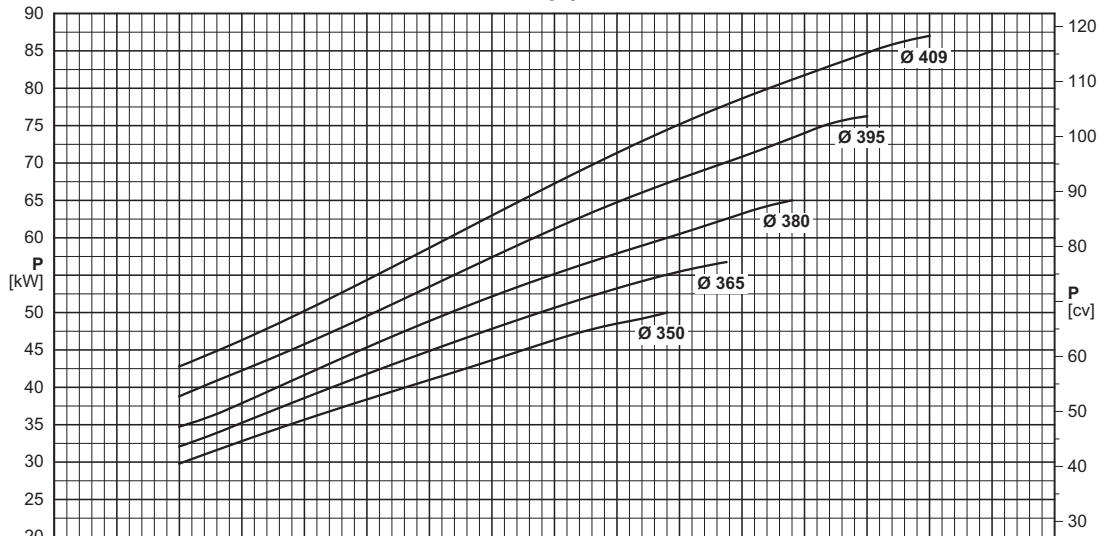
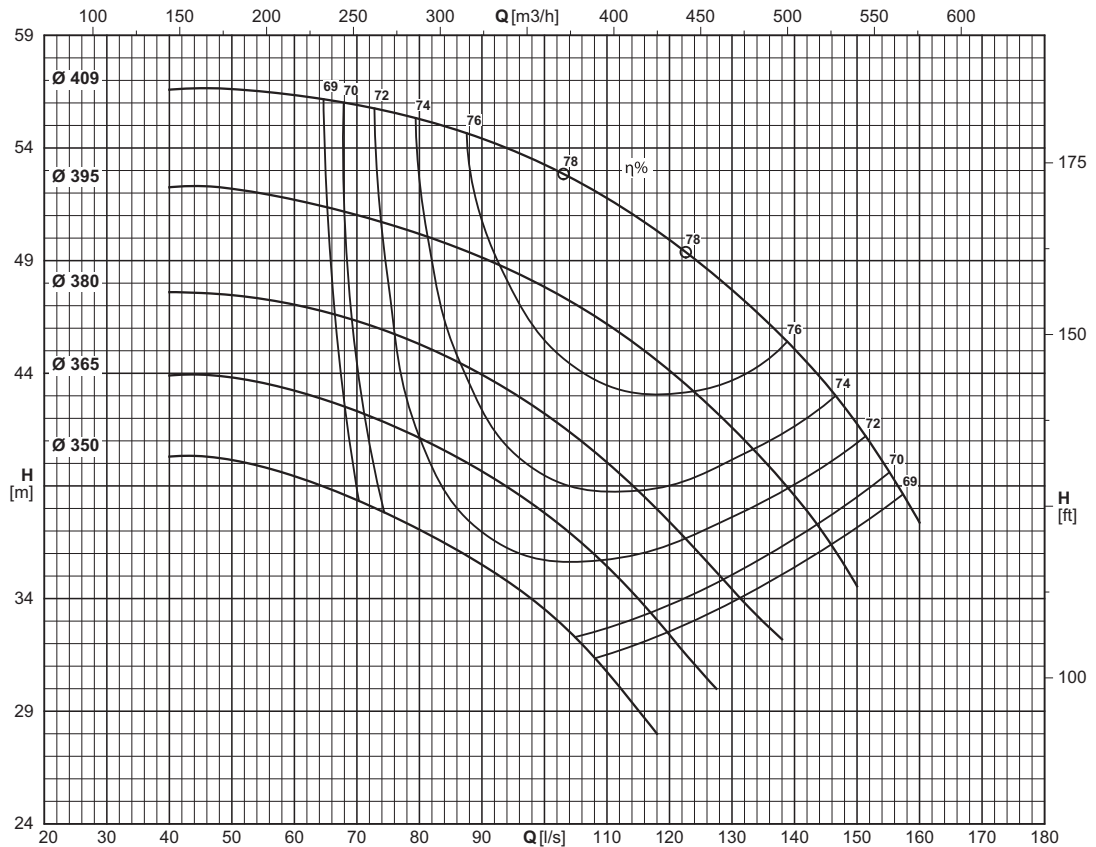

Type Type Tipo	Inlet maximum pressure (*) Pression maximale en aspiration (*) Pressione massima in aspirazione (*)	Dynamic momentum J Momentum dynamique J Momento dinamico J	
		With cast iron impellers Avec roues en fonte Con giranti in ghisa	With AISI 316 impellers Avec roues en AISI 316 Con giranti in AISI 316
		$J = \frac{1}{2}PD^2$	
	[bar]	[kgm <sup>2</sup> ]	
NC150-400	3	0,321632	(F) 0,3675795

Construction reference standard EN733 (DIN24255)  
 (\*) Value referred to the impeller with maximum diameter.

Norme de référence construction EN733 (DIN24255)  
 (\*) Valeur se référant à la roue à ailettes avec le diamètre maximum.

Norma di riferimento costruttivo EN733 (DIN24255)  
 (\*) Valore riferito alla girante con diametro massimo.

# NCH 150-500

1450 n [min<sup>-1</sup>]



Operating data  
Caracteristiques de fonctionnement  
Caratteristiche di funzionamento

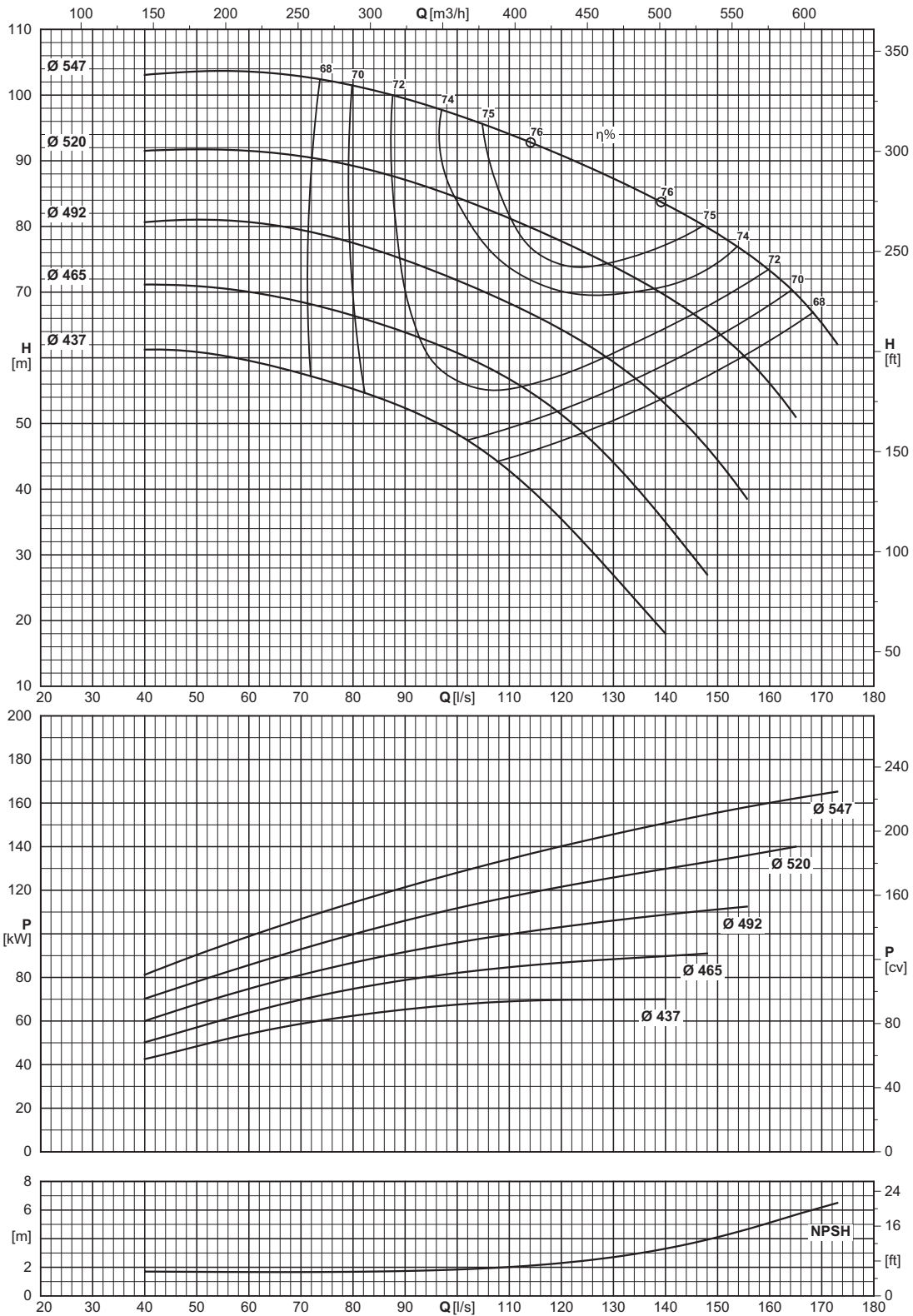

Type Type Tipo	Inlet maximum pressure (*) Pression maximale en aspiration (*) Pressione massima in aspirazione (*)	Dynamic momentum J Momentum dynamique J Momento dinamico J	
		With cast iron impellers Avec roues en fonte Con giranti in ghisa	With AISI 316 impellers Avec roues en AISI 316 Con giranti in AISI 316
		J = 1/4 PD <sup>2</sup>	
	[bar]	[kgm <sup>2</sup> ]	[kgm <sup>2</sup> ]
NCH150-500	5	1,2431564	(F) 1,420750

(\*) Value referred to the impeller with maximum diameter.

(\*) Valeur se référant à la roue à ailettes avec le diamètre maximum. (\*) Valore riferito alla girante con diametro massimo.

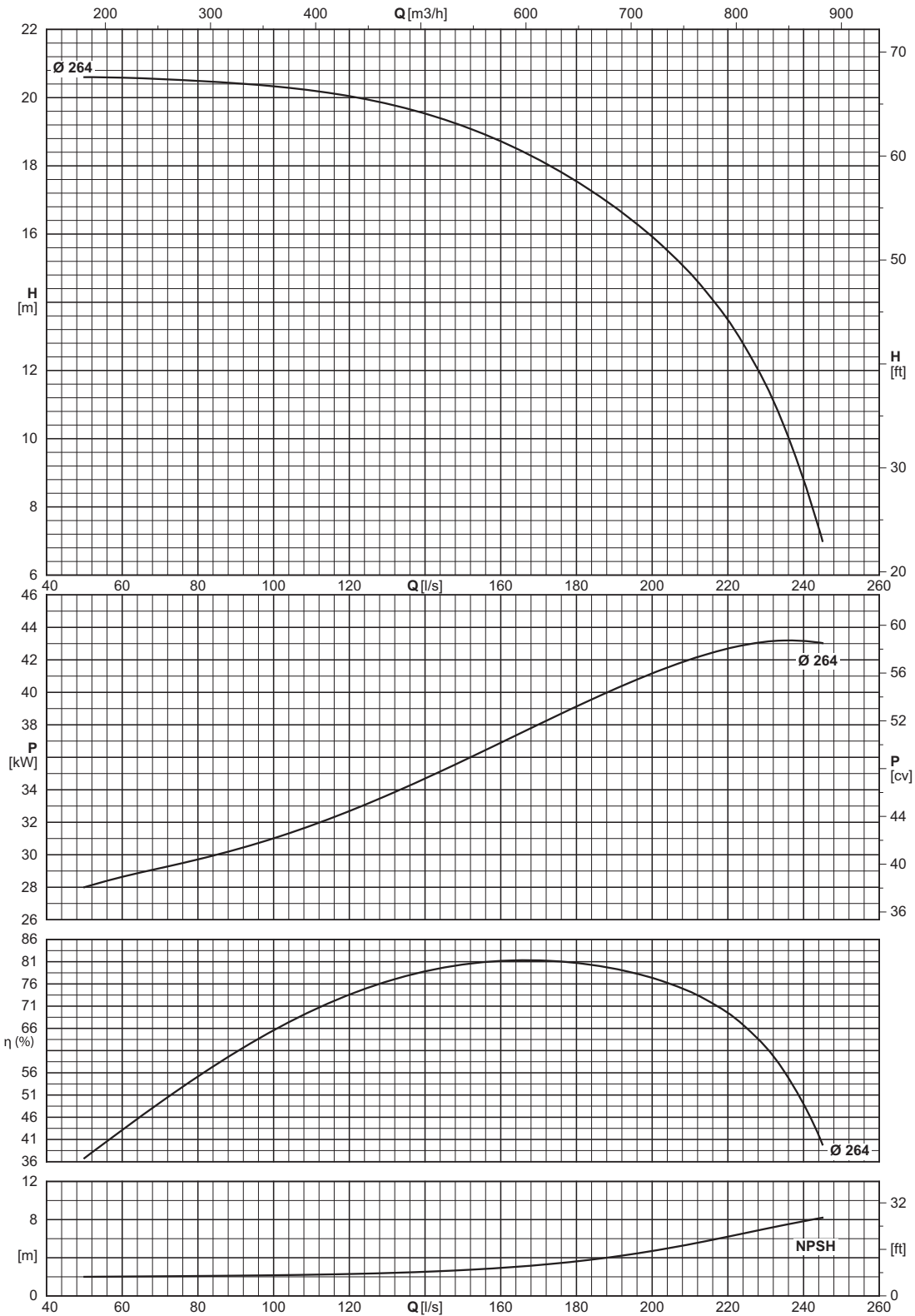

Type Type Tipo	Inlet maximum pressure (*) Pression maximale en aspiration (*) Pressione massima in aspirazione (*)	Dynamic momentum J Momentum dynamique J Momento dinamico J	
		With cast iron impellers Avec roues en fonte Con giranti in ghisa	With AISI 316 impellers Avec roues en AISI 316 Con giranti in AISI 316
		$J = \frac{1}{2}PD^2$	
	[bar]	[kgm <sup>2</sup> ]	
NC200-250	6	0,113824	(F) 0,1300846

Construction reference standard EN733 (DIN24255)  
 (\*) Value referred to the impeller with maximum diameter.

Norme de référence construction EN733 (DIN24255)  
 (\*) Valeur se référant à la roue à ailettes avec le diamètre maximum.

Norma di riferimento costruttivo EN733 (DIN24255)  
 (\*) Valore riferito alla girante con diametro massimo.

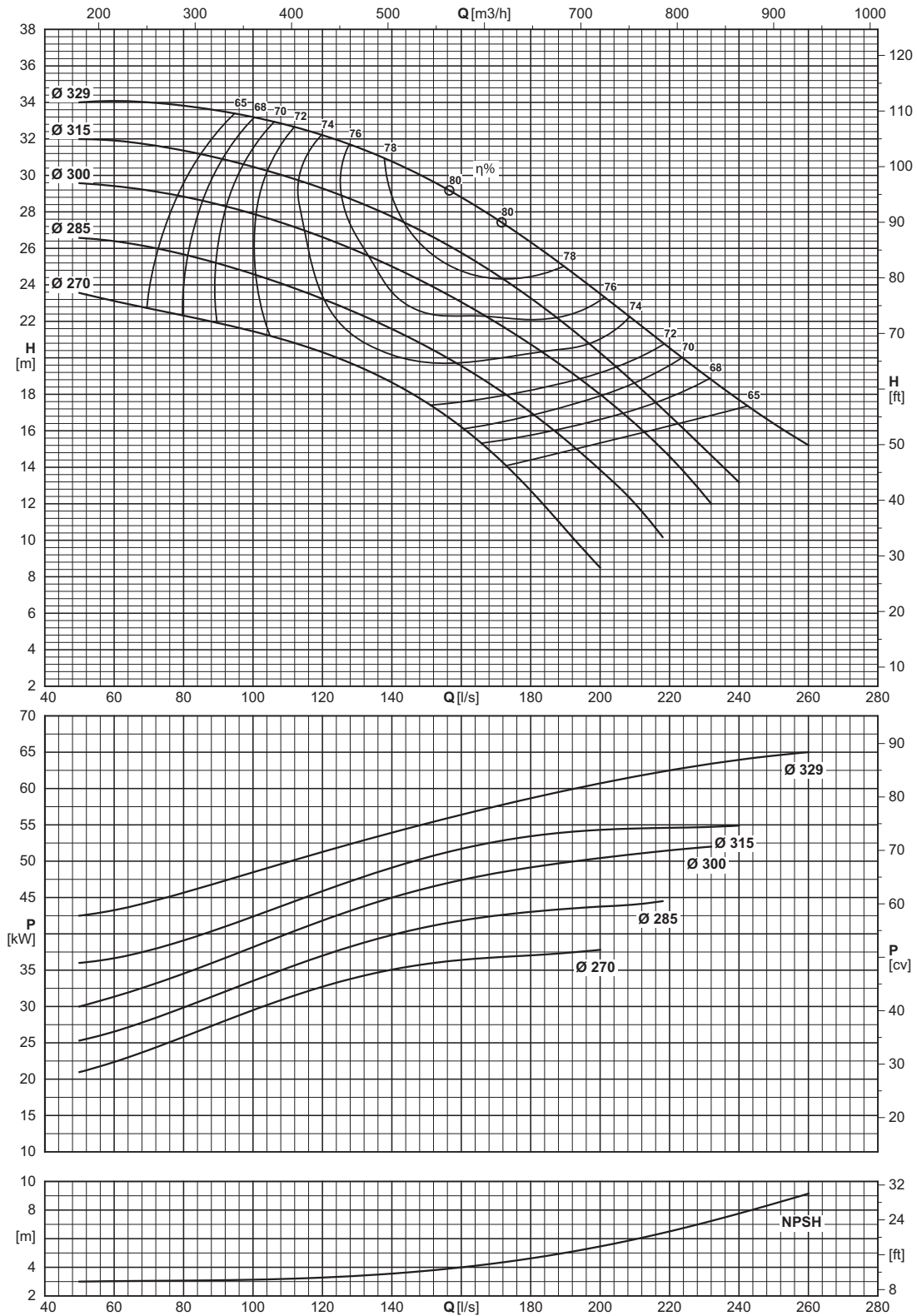

Type Type Tipo	Inlet maximum pressure (*) Pression maximale en aspiration (*) Pressione massima in aspirazione (*)	Dynamic momentum J Momentum dynamique J Momento dinamico J	
		With cast iron impellers Avec roues en fonte Con giranti in ghisa	With AISI 316 impellers Avec roues en AISI 316 Con giranti in AISI 316
		J = 1/4 PD <sup>2</sup>	
	[bar]	[kgm <sup>2</sup> ]	[kgm <sup>2</sup> ]
NC200-315	5	0,2618818	(F) 0,2992934

Construction reference standard EN733 (DIN24255)  
 (\*) Value referred to the impeller with maximum diameter.

Norme de référence construction EN733 (DIN24255)  
 (\*) Valeur se référant à la roue à ailettes avec le diamètre maximum.

Norma di riferimento costruttivo EN733 (DIN24255)  
 (\*) Valore riferito alla girante con diametro massimo.



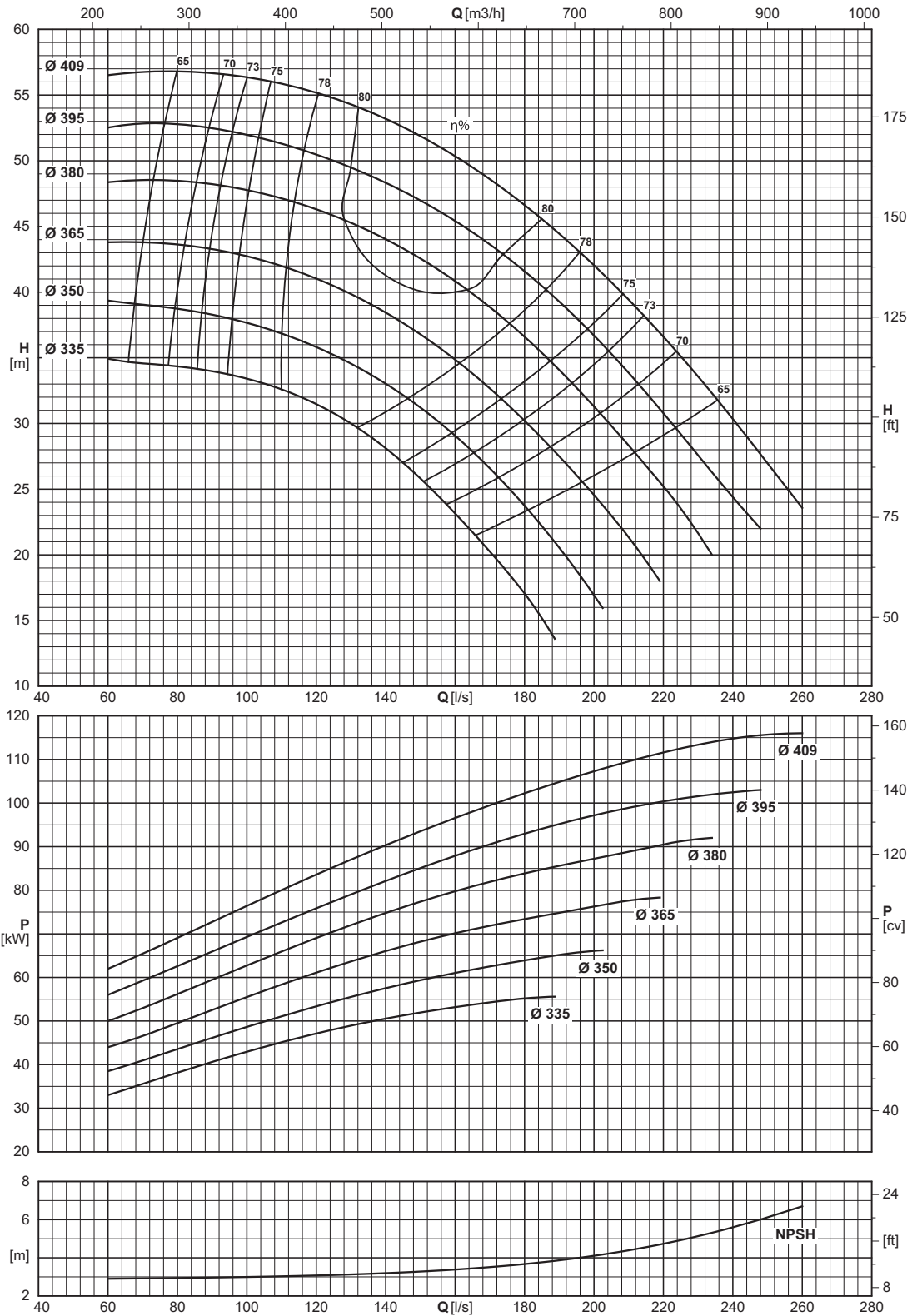

Type Type Tipo	Inlet maximum pressure (*) Pression maximale en aspiration (*) Pressione massima in aspirazione (*)	Dynamic momentum J Momentum dynamique J Momento dinamico J	
		With cast iron impellers Avec roues en fonte Con giranti in ghisa	With AISI 316 impellers Avec roues en AISI 316 Con giranti in AISI 316
		J=1/4PD <sup>2</sup>	
	[bar]	[kgm <sup>2</sup> ]	[kgm <sup>2</sup> ]
NC200-400	3	0,5502445	(F) 0,6288509

Construction reference standard EN733 (DIN24255)  
 (\*) Value referred to the impeller with maximum diameter.

Norme de référence construction EN733 (DIN24255)  
 (\*) Valeur se référant à la roue à ailettes avec le diamètre maximum.

Norma di riferimento costruttivo EN733 (DIN24255)  
 (\*) Valore riferito alla girante con diametro massimo.

# NCH 200-500

1450 n [min<sup>-1</sup>]



Operating data  
Caracteristiques de fonctionnement  
Caratteristiche di funzionamento

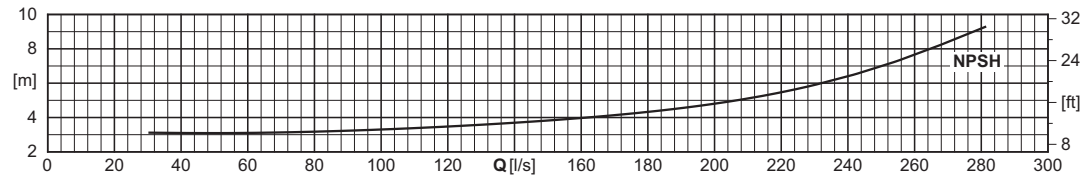
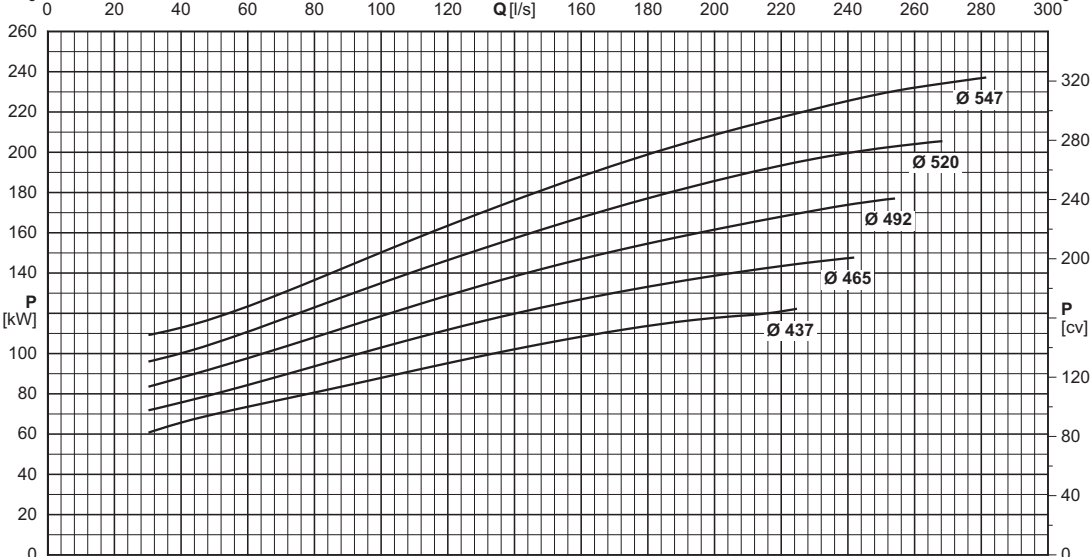
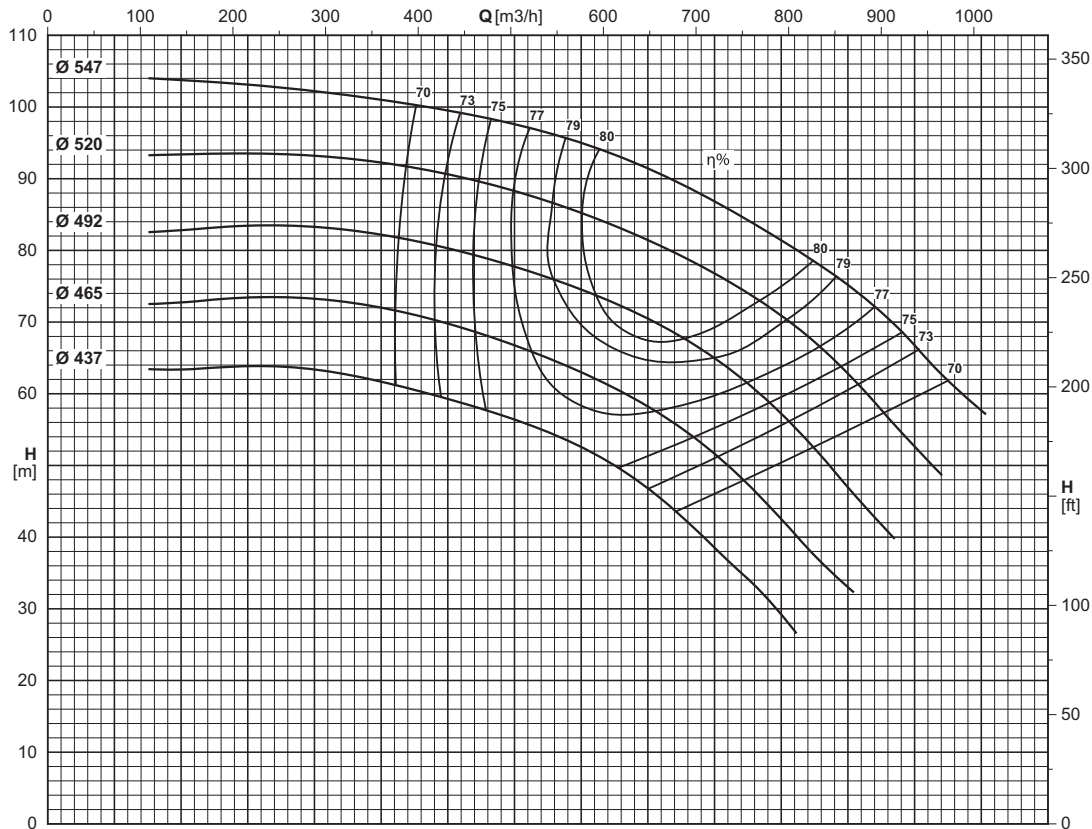

Type Type Tipo	Inlet maximum pressure (*) Pression maximale en aspiration (*) Pressione massima in aspirazione (*)	Dynamic momentum J Momentum dynamique J Momento dinamico J	
		With cast iron impellers Avec roues en fonte Con giranti in ghisa	With AISI 316 impellers Avec roues en AISI 316 Con giranti in AISI 316
		J = 1/4 PD <sup>2</sup>	
	[bar]	[kgm <sup>2</sup> ]	
NCH200-500	0	0	(F) 0

(\*) Value referred to the impeller with maximum diameter.

(\*) Valeur se référant à la roue à ailettes avec le diamètre maximum. (\*) Valore riferito alla girante con diametro massimo.

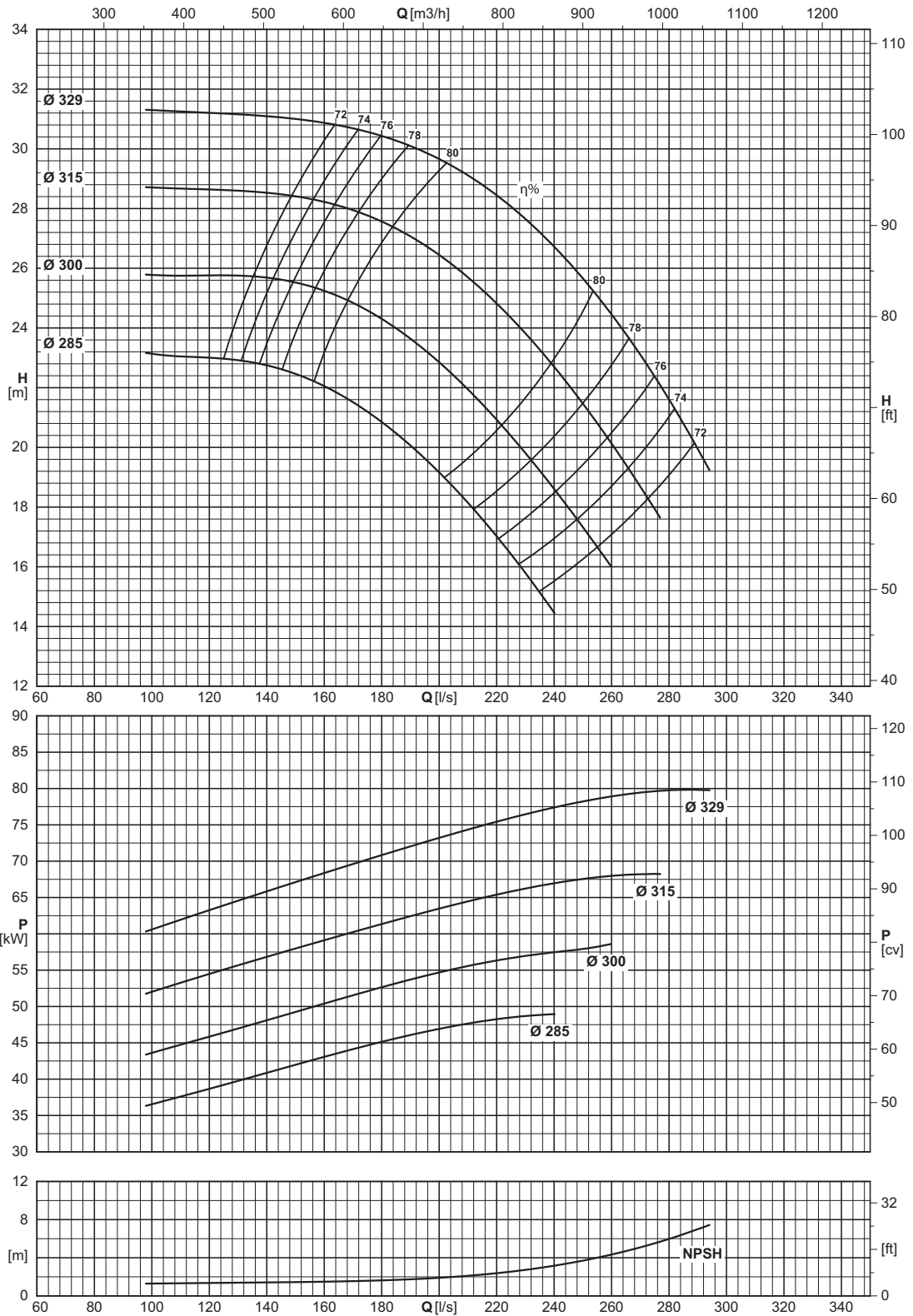

Type Type Tipo	Inlet maximum pressure (*) Pression maximale en aspiration (*) Pressione massima in aspirazione (*)	Dynamic momentum J Momentum dynamique J Momento dinamico J	
		With cast iron impellers Avec roues en fonte Con giranti in ghisa	With AISI 316 impellers Avec roues en AISI 316 Con giranti in AISI 316
		J=1/4PD²	
	[bar]	[kgm²]	[kgm²]
NC250-315	5	0,2963399	(F) 0,3386741

Construction reference standard EN733 (DIN24255)  
(\*) Value referred to the impeller with maximum diameter.

Norme de référence construction EN733 (DIN24255)  
(\*) Valeur se référant à la roue à ailettes avec le diamètre maximum.

Norma di riferimento costruttivo EN733 (DIN24255)  
(\*) Valore riferito alla girante con diametro massimo.

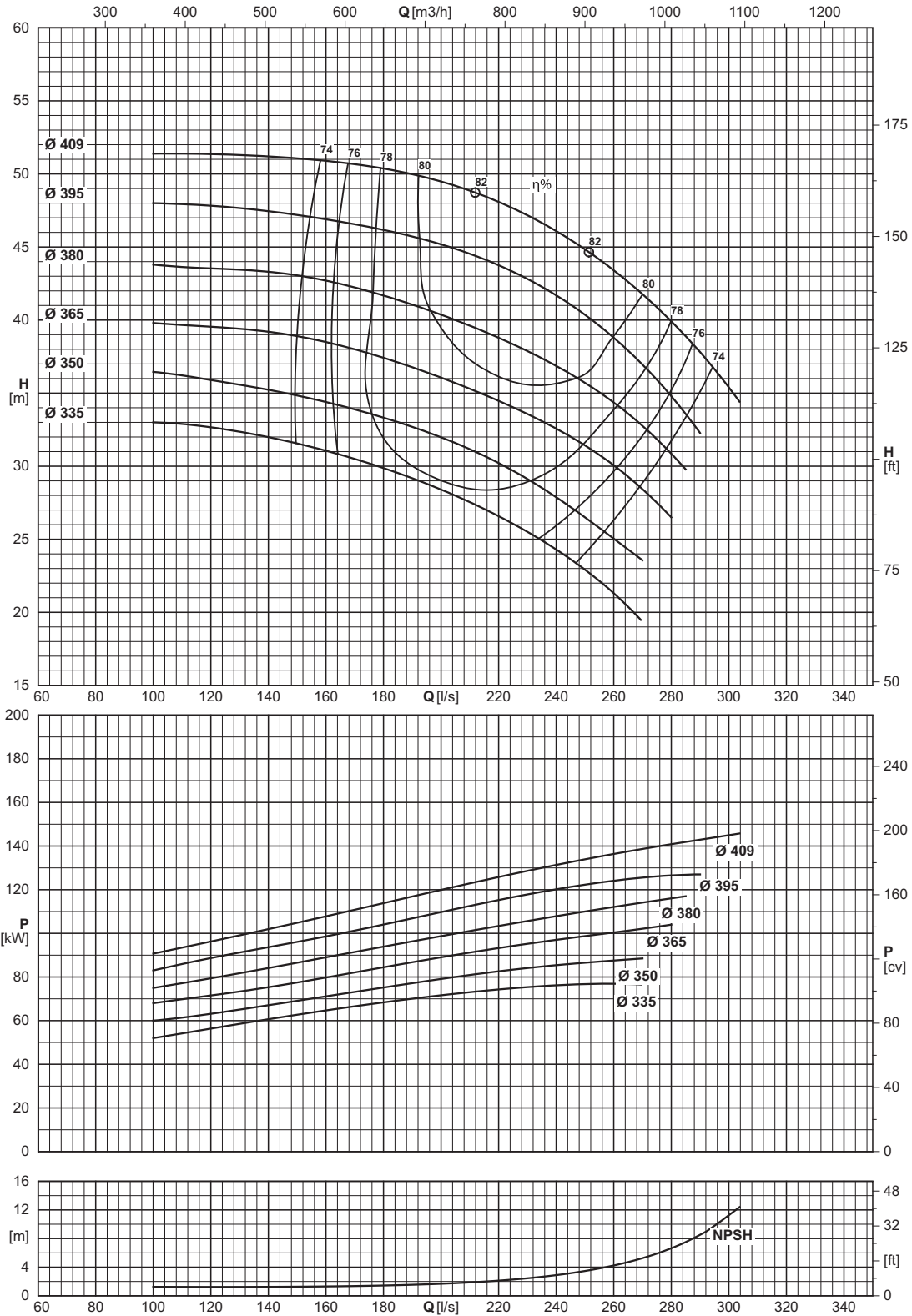

Type Type Tipo	Inlet maximum pressure (*) Pression maximale en aspiration (*) Pressione massima in aspirazione (*)	Dynamic momentum J Momentum dynamique J Momento dinamico J	
		With cast iron impellers Avec roues en fonte Con giranti in ghisa	With AISI 316 impellers Avec roues en AISI 316 Con giranti in AISI 316
		J=1/4PD <sup>2</sup>	
	[bar]	[kgm <sup>2</sup> ]	[kgm <sup>2</sup> ]
NC250-400	3	0,6137343	(F) 0,7014106

Construction reference standard EN733 (DIN24255)  
(\*) Value referred to the impeller with maximum diameter.

Norme de référence construction EN733 (DIN24255)  
(\*) Valeur se référant à la roue à ailettes avec le diamètre maximum.

Norma di riferimento costruttivo EN733 (DIN24255)  
(\*) Valore riferito alla girante con diametro massimo.

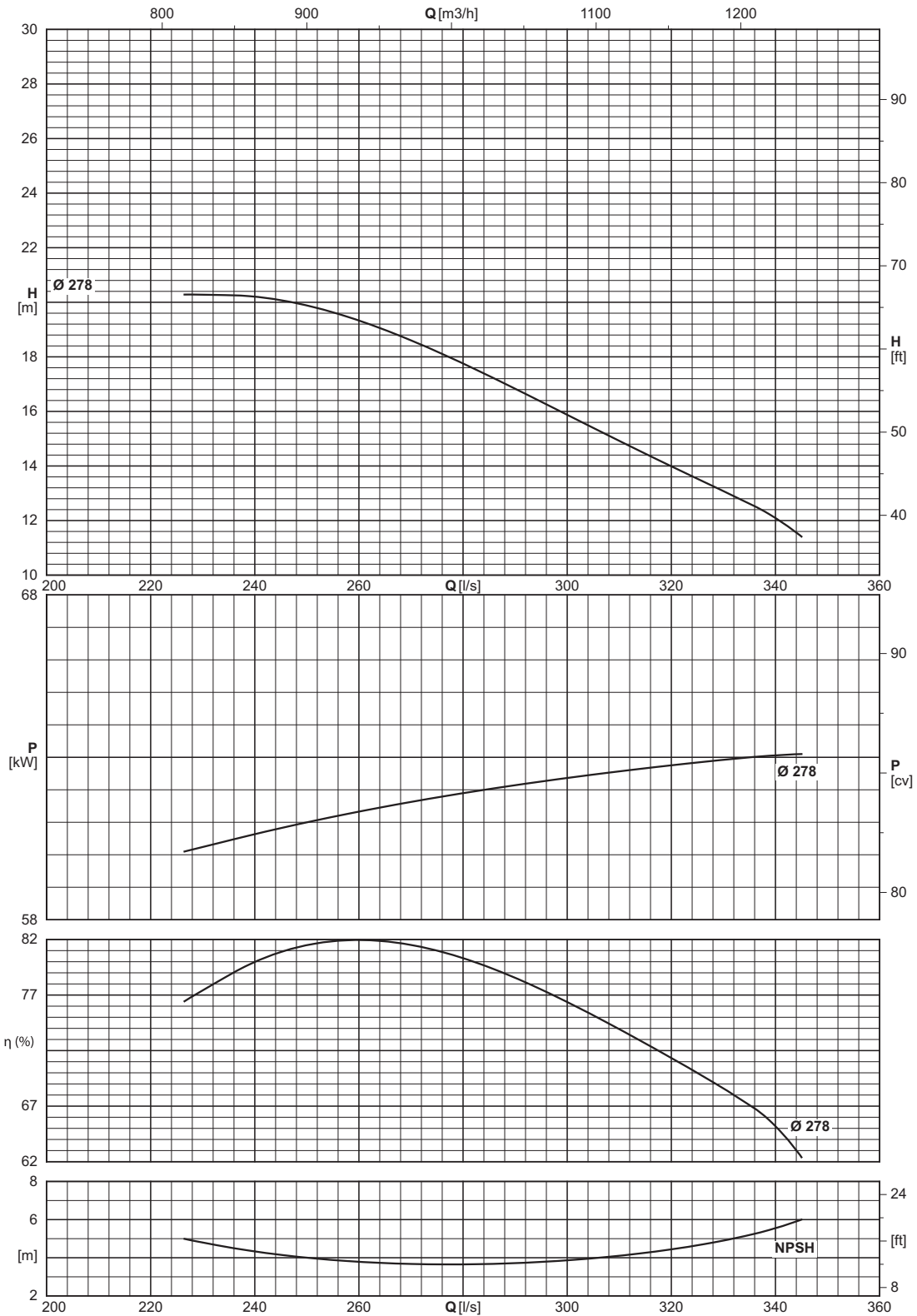

Type Type Tipo	Inlet maximum pressure (*) Pression maximale en aspiration (*) Pressione massima in aspirazione (*)	Dynamic momentum J Momentum dynamique J Momento dinamico J	
		With cast iron impellers Avec roues en fonte Con giranti in ghisa	With AISI 316 impellers Avec roues en AISI 316 Con giranti in AISI 316
		J=1/4PD <sup>2</sup>	
	[bar]	[kgm <sup>2</sup> ]	
NCH250-250	6	0	(F) 0

(\*) Value referred to the impeller with maximum diameter.

(\*) Valeur se référant à la roue à ailettes avec le diamètre maximum. (\*) Valore riferito alla girante con diametro massimo.

# NCH 250-500

1450 n [min<sup>-1</sup>]



Operating data  
Caracteristiques de fonctionnement  
Caratteristiche di funzionamento

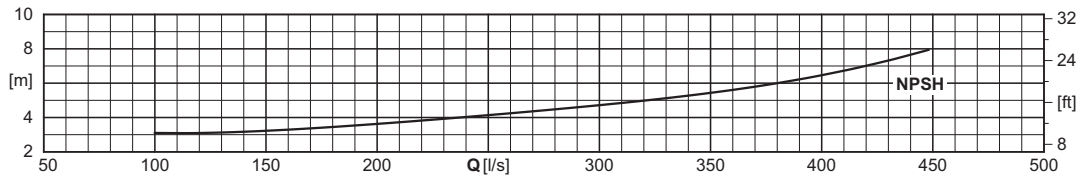
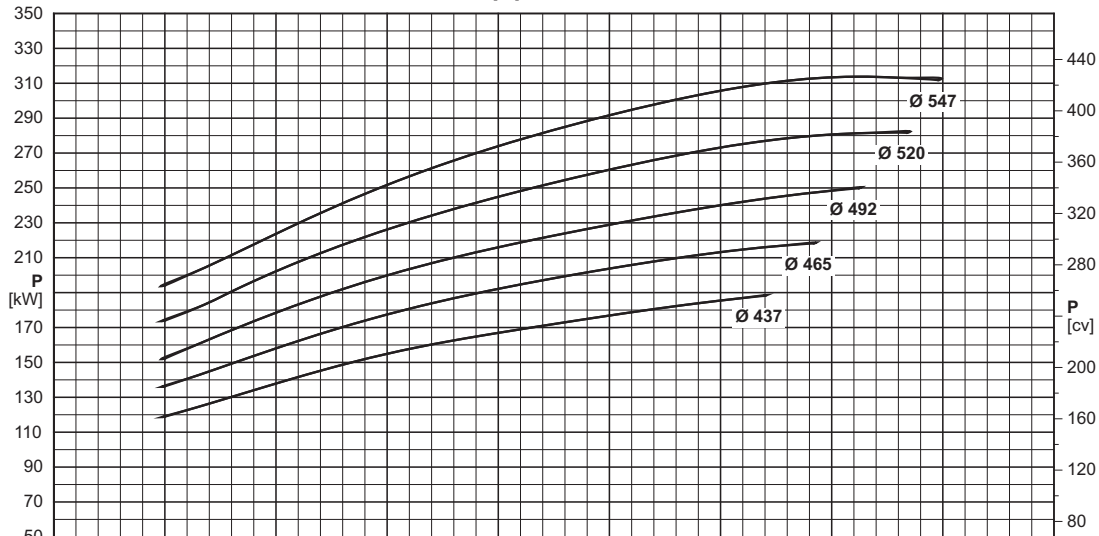
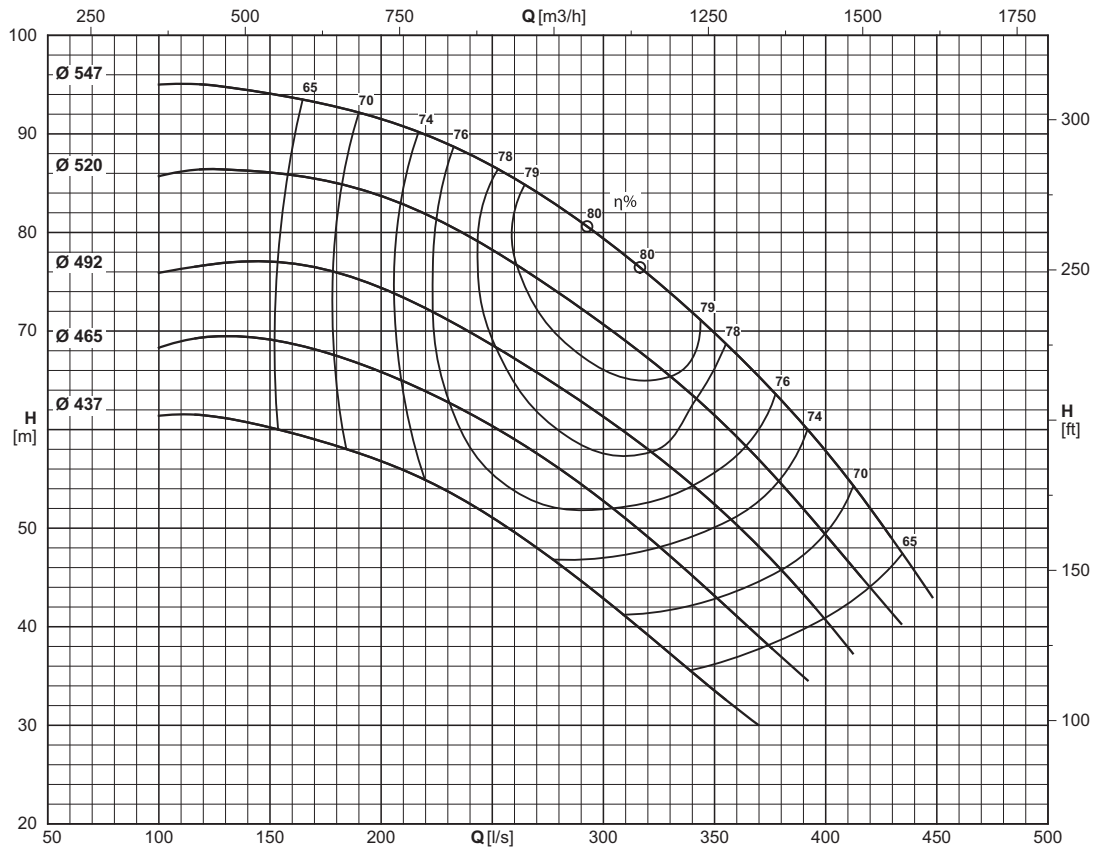

Type Type Tipo	Inlet maximum pressure (*) Pression maximale en aspiration (*) Pressione massima in aspirazione (*)	Dinamic momentum J Momentum dynamique J Momento dinamico J	
		With cast iron impellers Avec roues en fonte Con giranti in ghisa	With AISI 316 impellers Avec roues en AISI 316 Con giranti in AISI 316
		J=1/4PD <sup>2</sup>	
[bar]		[kgm <sup>2</sup> ]	
NCH250-500	0.5	0	(F) 0

(\*) Value referred to the impeller with maximum diameter.

(\*) Valeur se référant à la roue à ailettes avec le diamètre maximum. (\*) Valore riferito alla girante con diametro massimo.

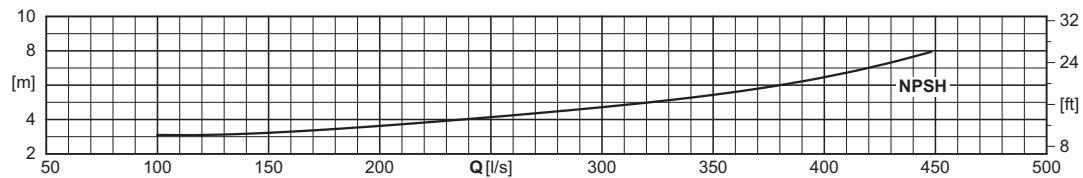
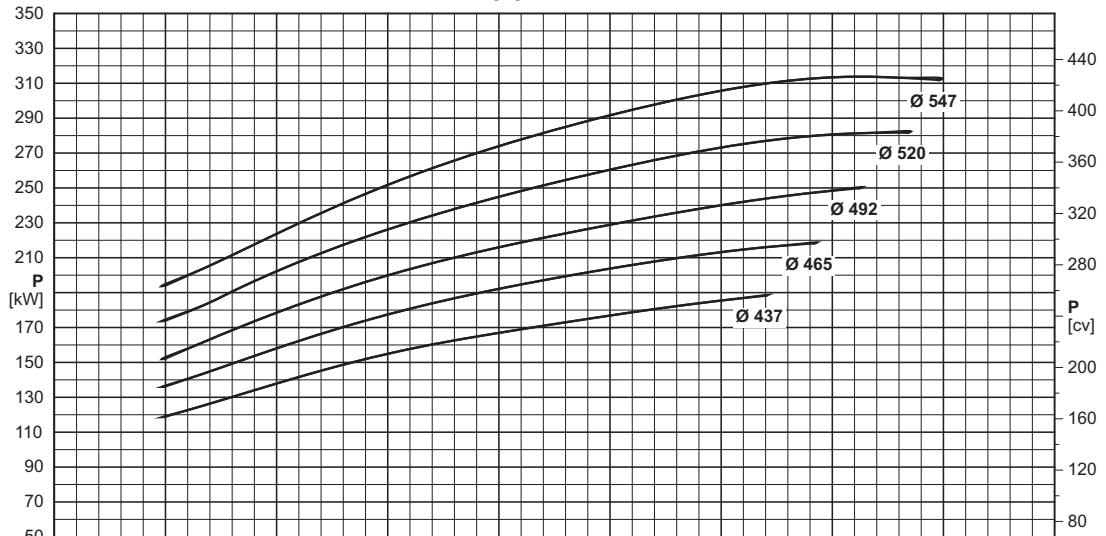
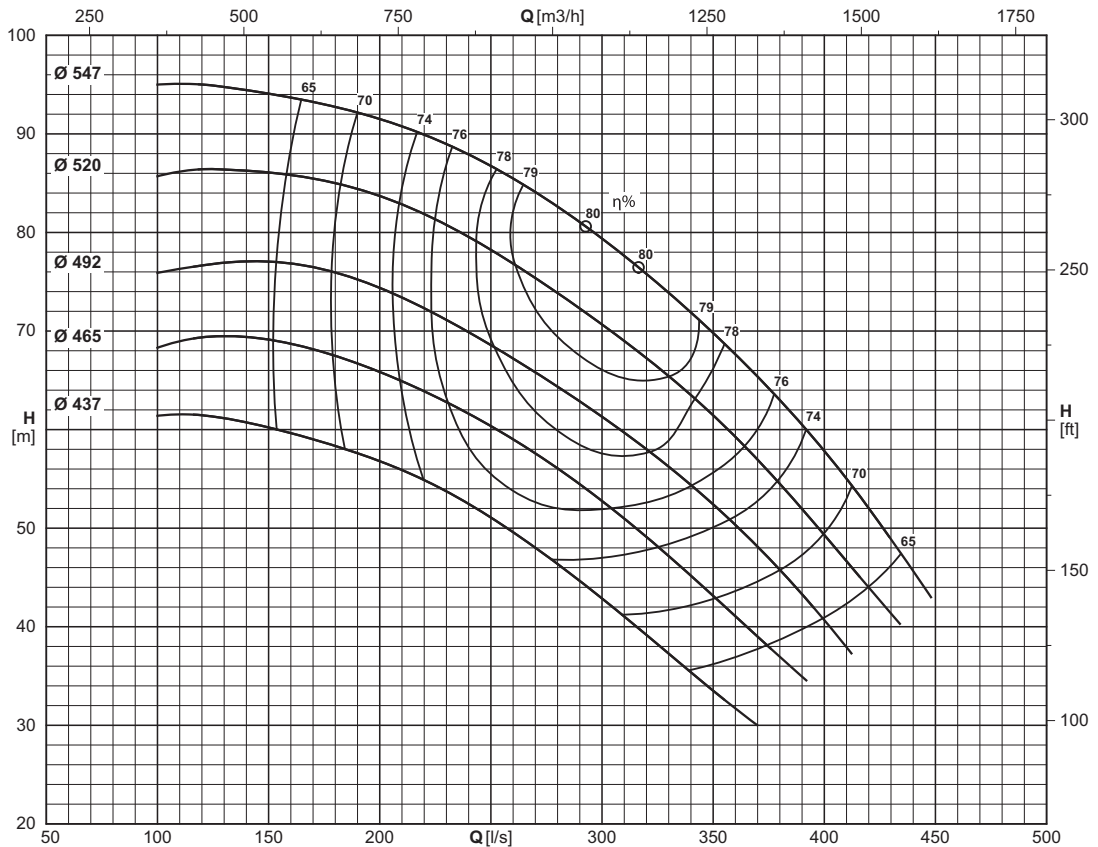

Type Type Tipo	Inlet maximum pressure (*) Pression maximale en aspiration (*) Pressione massima in aspirazione (*)	Dynamic momentum J Momentum dynamique J Momento dinamico J	
		With cast iron impellers Avec roues en fonte Con giranti in ghisa	With AISI 316 impellers Avec roues en AISI 316 Con giranti in AISI 316
		$J = \frac{1}{4}PD^2$	
	[bar]	[kgm <sup>2</sup> ]	
NCHF250-500	0.5	0	(F) 0

(\*) Value referred to the impeller with maximum diameter.

(\*) Valeur se référant à la roue à ailettes avec le diamètre maximum. (\*) Valore riferito alla girante con diametro massimo.

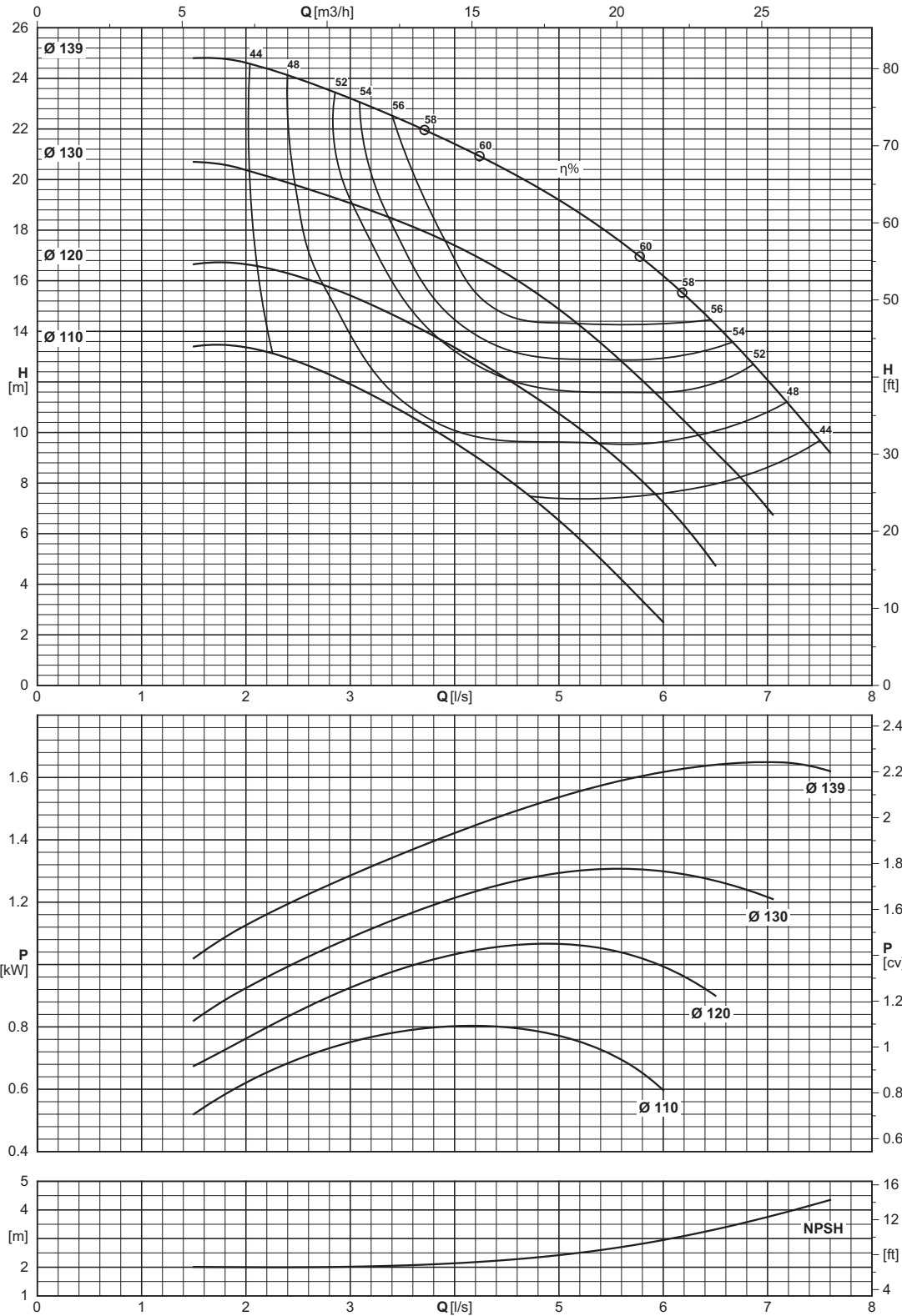

Type Type Tipo	Inlet maximum pressure (*) Pression maximale en aspiration (*) Pressione massima in aspirazione (*)	Dynamic momentum J Momentum dynamique J Momento dinamico J	
		With cast iron impellers Avec roues en fonte Con giranti in ghisa	With AISI 316 impellers Avec roues en AISI 316 Con giranti in AISI 316
		J = 1/4 PD <sup>2</sup>	
	[bar]	[kgm <sup>2</sup> ]	
NC32-125	6	0,0027116	(F) 0,003099

Construction reference standard EN733 (DIN24255)  
(\*) Value referred to the impeller with maximum diameter.

Norme de référence construction EN733 (DIN24255)  
(\*) Valeur se référant à la roue à ailettes avec le diamètre maximum.

Norma di riferimento costruttivo EN733 (DIN24255)  
(\*) Valore riferito alla girante con diametro massimo.



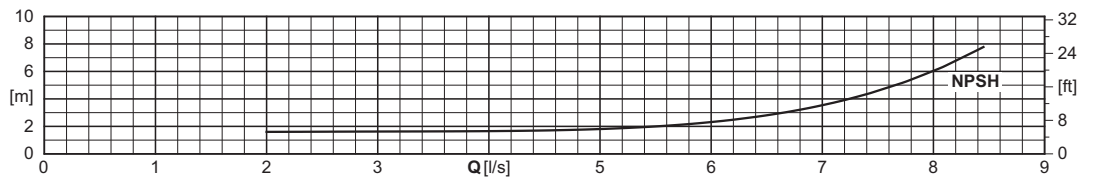
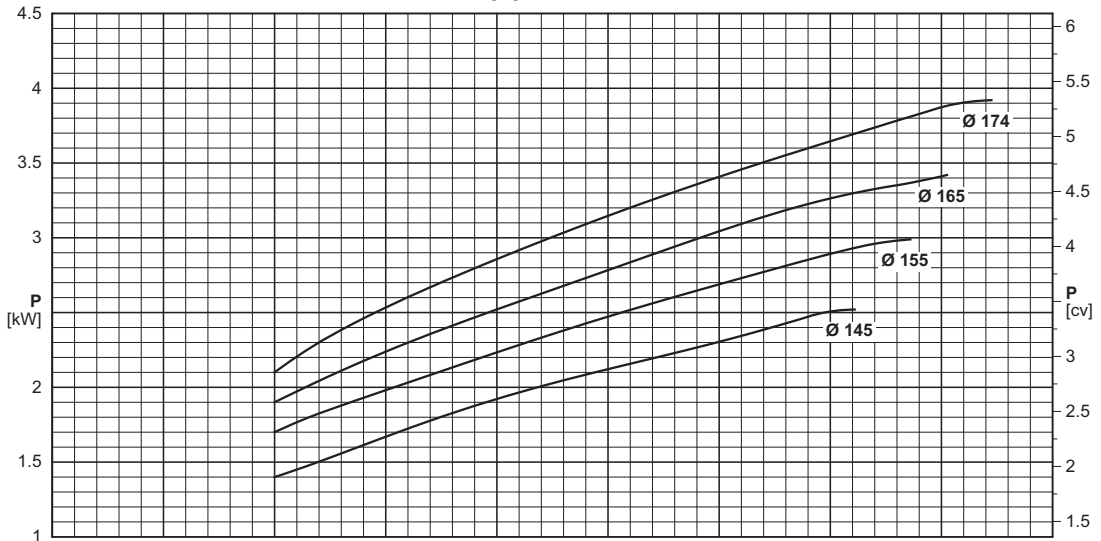
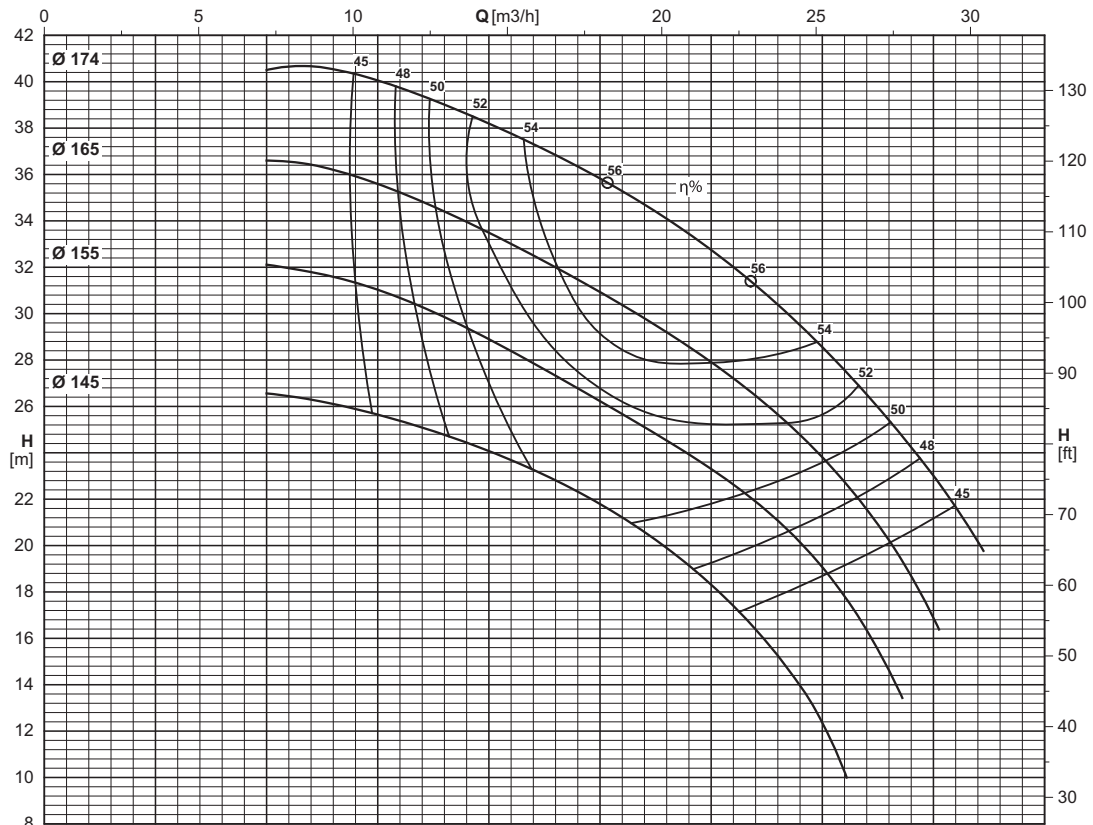

Type Type Tipo	Inlet maximum pressure (*) Pression maximale en aspiration (*) Pressione massima in aspirazione (*)	Dynamic momentum J Momentum dynamique J Momento dinamico J	
		With cast iron impellers Avec roues en fonte Con giranti in ghisa	With AISI 316 impellers Avec roues en AISI 316 Con giranti in AISI 316
		J=1/4PD <sup>2</sup>	
	[bar]	[kgm <sup>2</sup> ]	[kgm <sup>2</sup> ]
NC32-160	5	0,0069021	(F) 0,0078881

Construction reference standard EN733 (DIN24255)  
 (\*) Value referred to the impeller with maximum diameter.

Norme de référence construction EN733 (DIN24255)  
 (\*) Valeur se référant à la roue à ailettes avec le diamètre maximum.

Norma di riferimento costruttivo EN733 (DIN24255)  
 (\*) Valore riferito alla girante con diametro massimo.

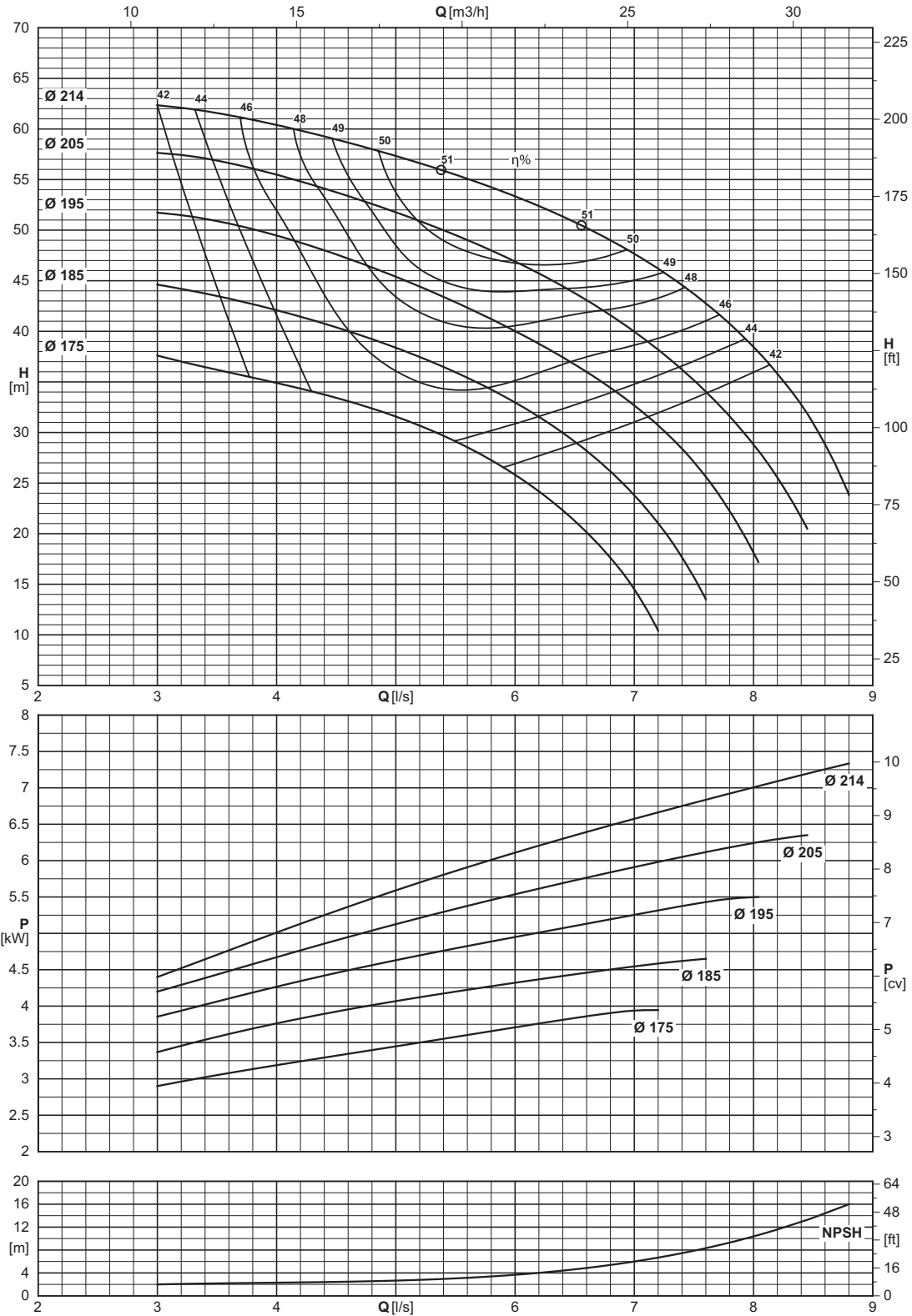

Type Type Tipo	Inlet maximum pressure (*) Pression maximale en aspiration (*) Pressione massima in aspirazione (*)	Dynamic momentum J Momentum dynamique J Momento dinamico J	
		With cast iron impellers Avec roues en fonte Con giranti in ghisa	With AISI 316 impellers Avec roues en AISI 316 Con giranti in AISI 316
		J = 1/4 PD <sup>2</sup>	
[bar]		[kgm <sup>2</sup> ]	
NC32-200	2	0,0132814	(F) 0,0151787

Construction reference standard EN733 (DIN24255)  
(\*) Value referred to the impeller with maximum diameter.

Norme de référence construction EN733 (DIN24255)  
(\*) Valeur se référant à la roue à ailettes avec le diamètre maximum.

Norma di riferimento costruttivo EN733 (DIN24255)  
(\*) Valore riferito alla girante con diametro massimo.

Operating data  
Caracteristiques de fonctionnement  
Caratteristiche di funzionamento

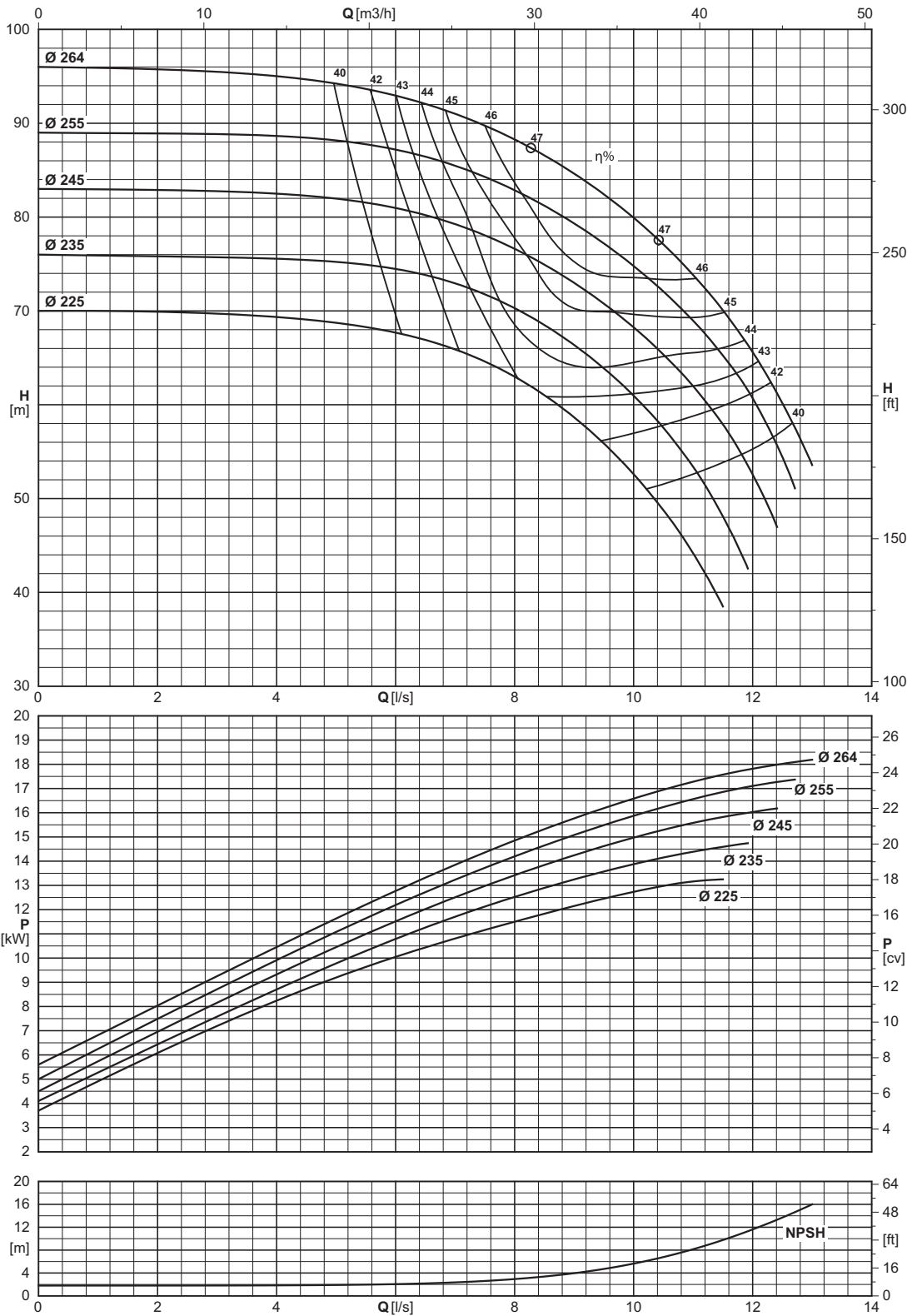

Type Type Tipo	Inlet maximum pressure (*) Pression maximale en aspiration (*) Pressione massima in aspirazione (*)	Dynamic momentum J Momentum dynamique J Momento dinamico J	
		With cast iron impellers Avec roues en fonte Con giranti in ghisa	With AISI 316 impellers Avec roues en AISI 316 Con giranti in AISI 316
		$J = \frac{1}{4}PD^2$	
	[bar]	[kgm <sup>2</sup> ]	
NC32-250	0	0,0297908	(F) 0,0340466

Construction reference standard EN733 (DIN24255)  
(\*) Value referred to the impeller with maximum diameter.

Norme de référence construction EN733 (DIN24255)  
(\*) Valeur se référant à la roue à ailettes avec le diamètre maximum.

Norma di riferimento costruttivo EN733 (DIN24255)  
(\*) Valore riferito alla girante con diametro massimo.

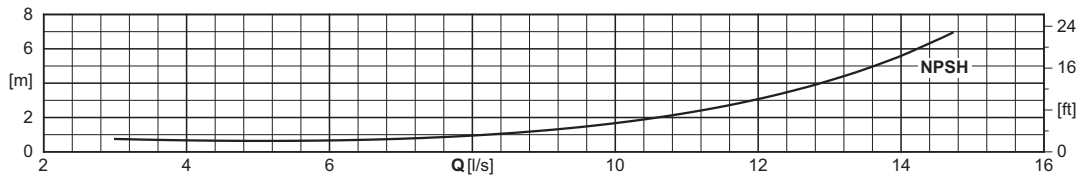
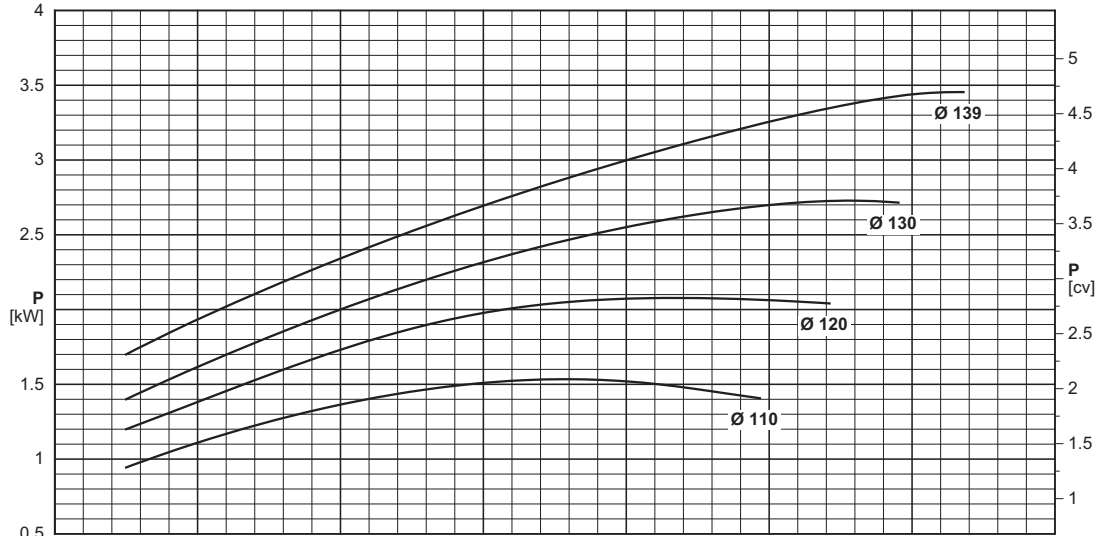
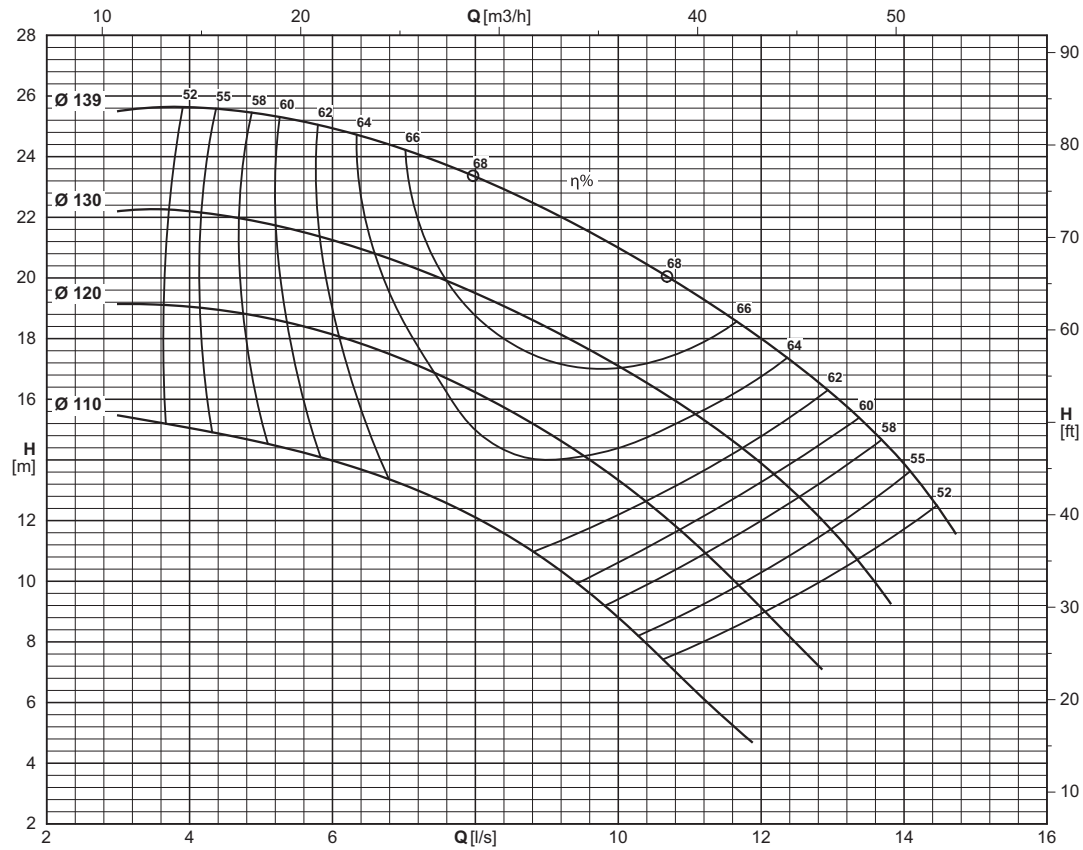

Type Type Tipo	Inlet maximum pressure (*) Pression maximale en aspiration (*) Pressione massima in aspirazione (*)	Dinamic momentum J Momentum dynamique J Momento dinamico J	
		With cast iron impellers Avec roues en fonte Con giranti in ghisa	With AISI 316 impellers Avec roues en AISI 316 Con giranti in AISI 316
		J = 1/4 PD <sup>2</sup>	
	[bar]	[kgm <sup>2</sup> ]	
NC40-125	6	0,0028102	(F) 0,0032117

Construction reference standard EN733 (DIN24255)  
(\*) Value referred to the impeller with maximum diameter.

Norme de référence construction EN733 (DIN24255)  
(\*) Valeur se référant à la roue à ailettes avec le diamètre maximum.

Norma di riferimento costruttivo EN733 (DIN24255)  
(\*) Valore riferito alla girante con diametro massimo.

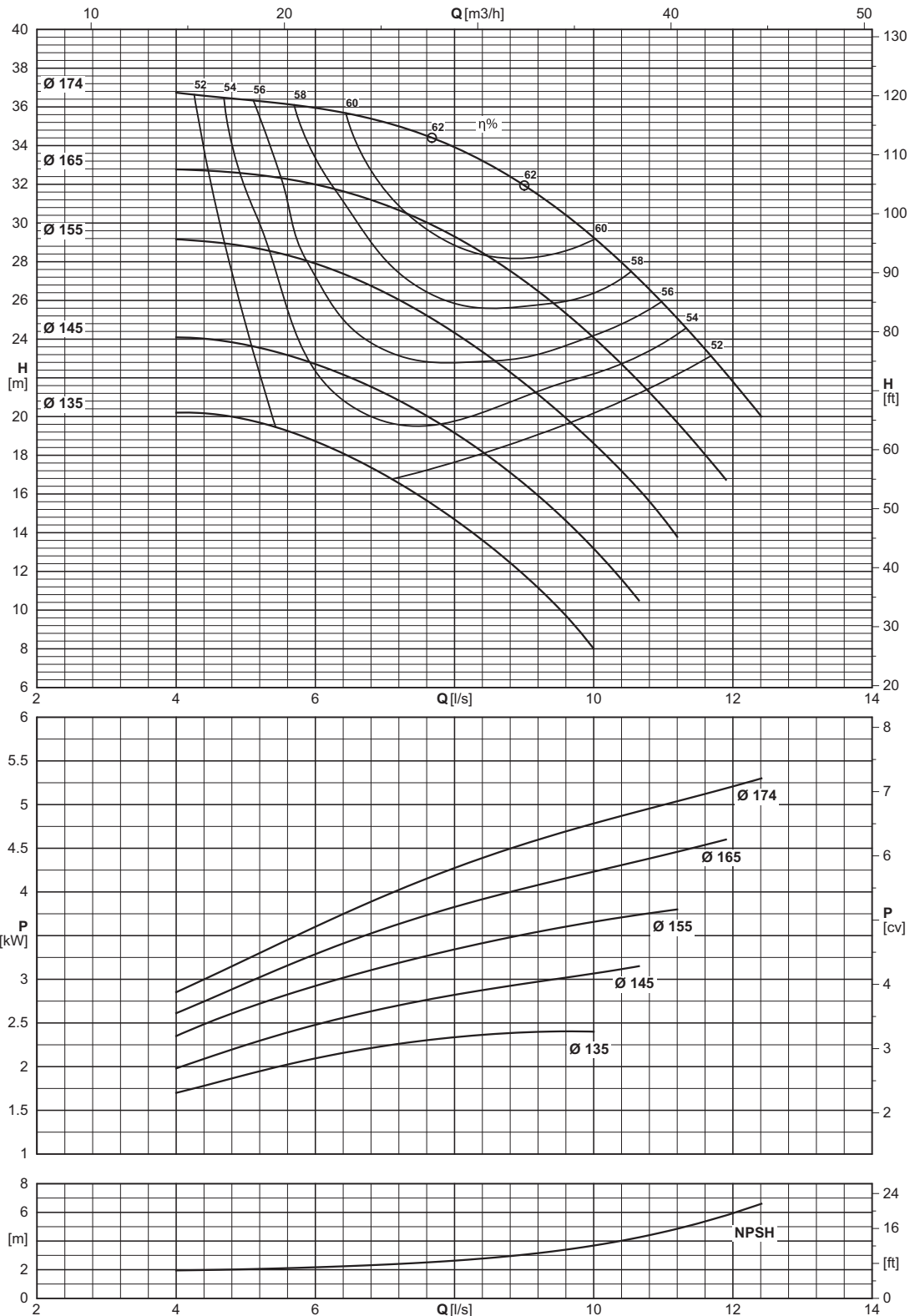

Type Type Tipo	Inlet maximum pressure (*) Pression maximale en aspiration (*) Pressione massima in aspirazione (*)	Dynamic momentum J Momentum dynamique J Momento dinamico J	
		With cast iron impellers Avec roues en fonte Con giranti in ghisa	With AISI 316 impellers Avec roues en AISI 316 Con giranti in AISI 316
		J = 1/4 PD <sup>2</sup>	
	[bar]	[kgm <sup>2</sup> ]	[kgm <sup>2</sup> ]
NC40-160	5	0,0077563	(F) 0,0088643

Construction reference standard EN733 (DIN24255)  
 (\*) Value referred to the impeller with maximum diameter.

Norme de référence construction EN733 (DIN24255)  
 (\*) Valeur se référant à la roue à ailettes avec le diamètre maximum.

Norma di riferimento costruttivo EN733 (DIN24255)  
 (\*) Valore riferito alla girante con diametro massimo.

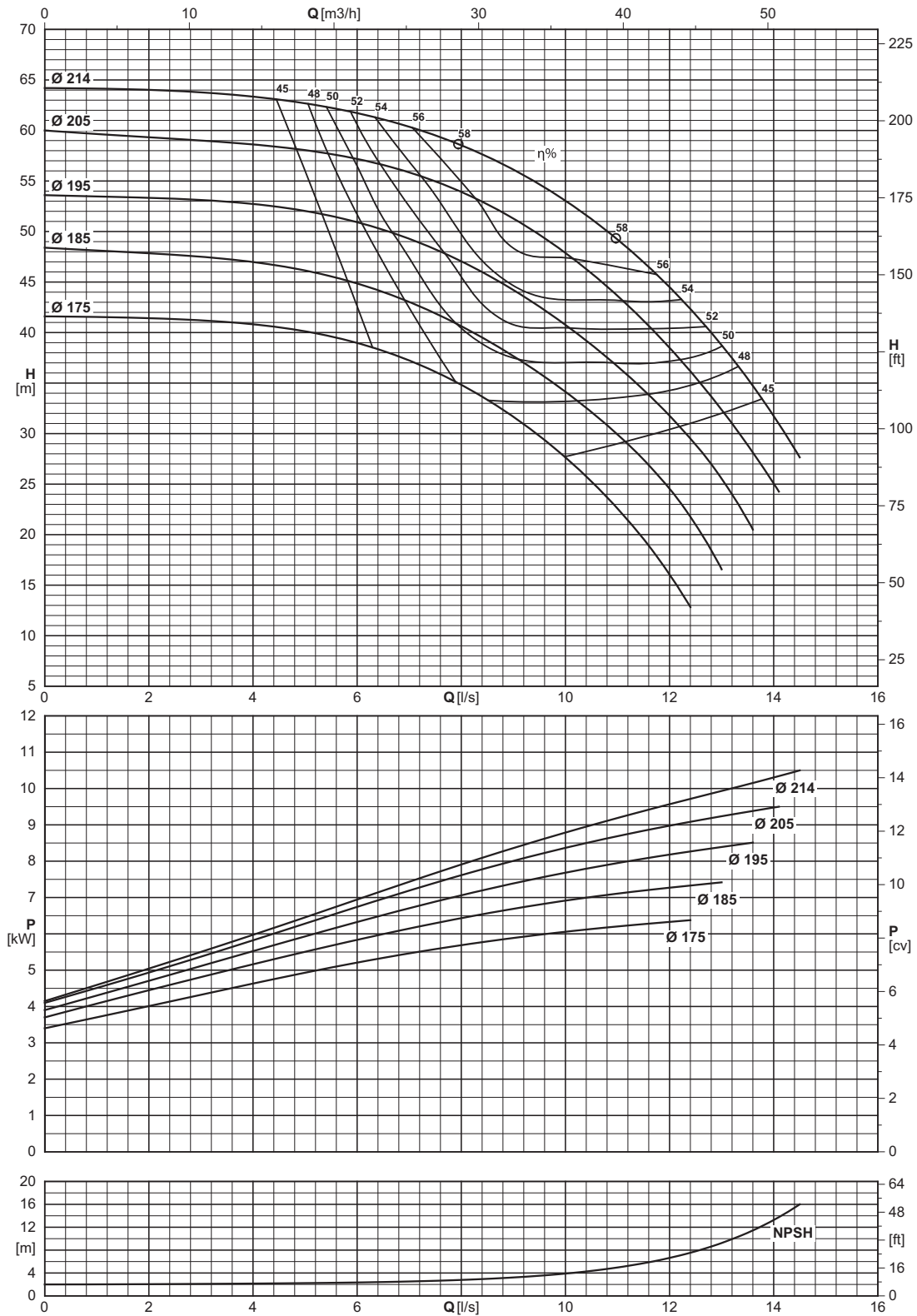

Type Type Tipo	Inlet maximum pressure (*) Pression maximale en aspiration (*) Pressione massima in aspirazione (*)	Dinamic momentum J Momentum dynamique J Momento dinamico J	
		With cast iron impellers Avec roues en fonte Con giranti in ghisa	With AISI 316 impellers Avec roues en AISI 316 Con giranti in AISI 316
		J = 1/4 PD <sup>2</sup>	
	[bar]	[kgm <sup>2</sup> ]	[kgm <sup>2</sup> ]
NC40-200	2	0,0158799	(F) 0,0181484

Construction reference standard EN733 (DIN24255)  
(\*) Value referred to the impeller with maximum diameter.

Norme de référence construction EN733 (DIN24255)  
(\*) Valeur se référant à la roue à ailettes avec le diamètre maximum.

Norma di riferimento costruttivo EN733 (DIN24255)  
(\*) Valore riferito alla girante con diametro massimo.

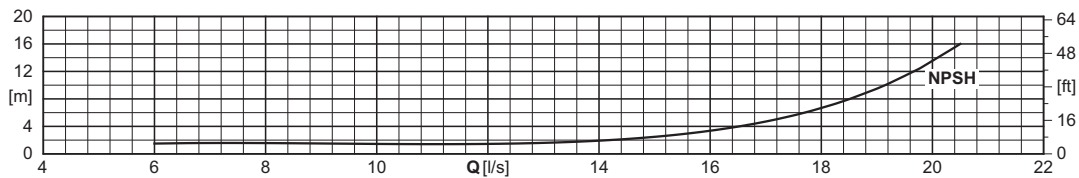
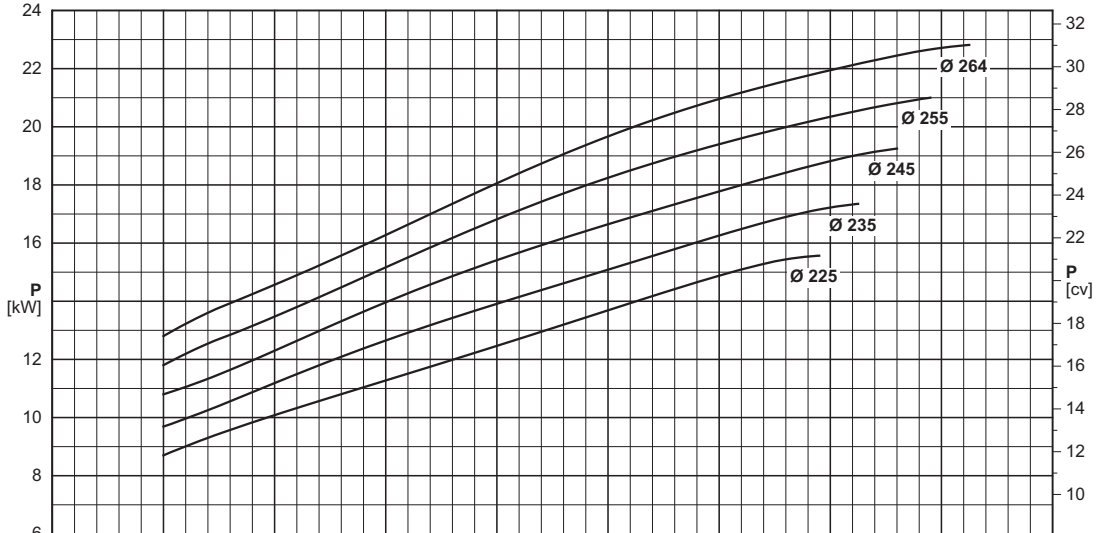
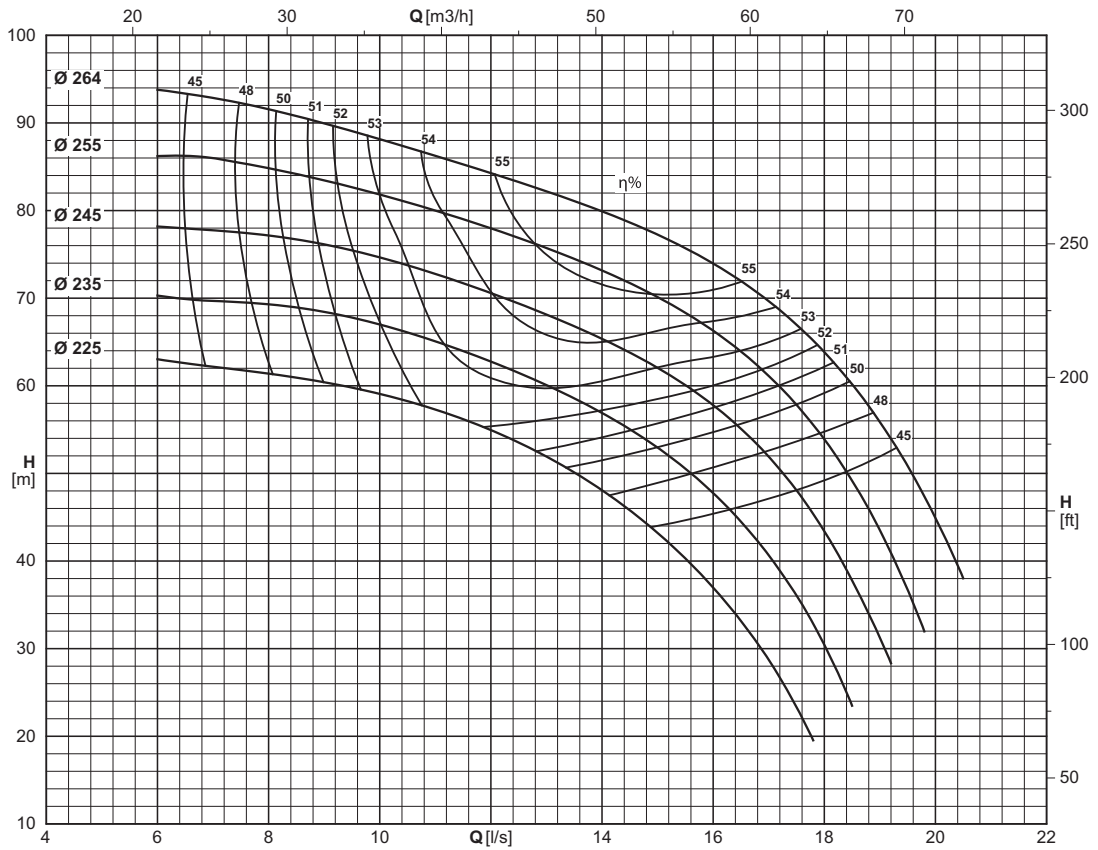

Type Type Tipo	Inlet maximum pressure (*) Pression maximale en aspiration (*) Pressione massima in aspirazione (*)	Dynamic momentum J Momentum dynamique J Momento dinamico J	
		With cast iron impellers Avec roues en fonte Con giranti in ghisa	With AISI 316 impellers Avec roues en AISI 316 Con giranti in AISI 316
		J=1/4PD <sup>2</sup>	
	[bar]	[kgm <sup>2</sup> ]	[kgm <sup>2</sup> ]
NC40-250	0	0,0411814	(F) 0,0470645

Construction reference standard EN733 (DIN24255)  
(\*) Value referred to the impeller with maximum diameter.

Norme de référence construction EN733 (DIN24255)  
(\*) Valeur se référant à la roue à ailettes avec le diamètre maximum.

Norma di riferimento costruttivo EN733 (DIN24255)  
(\*) Valore riferito alla girante con diametro massimo.

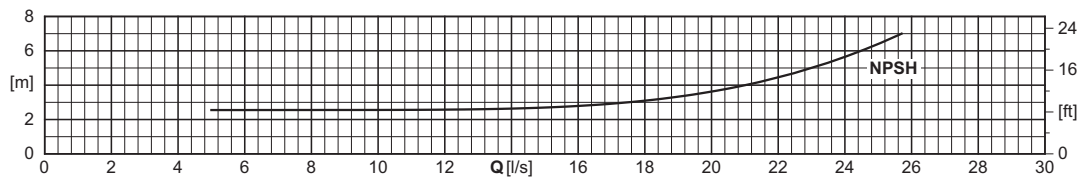
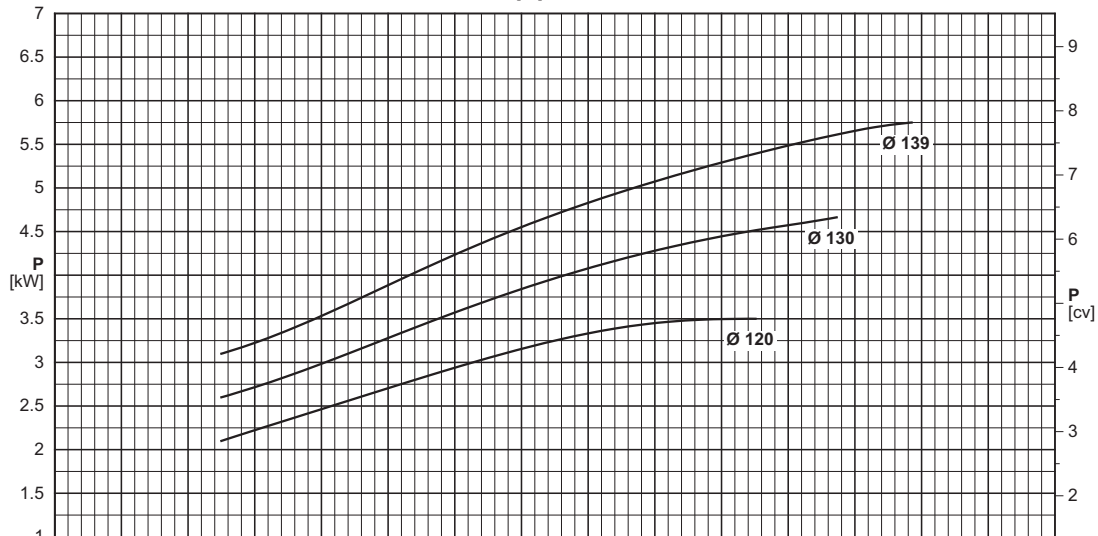
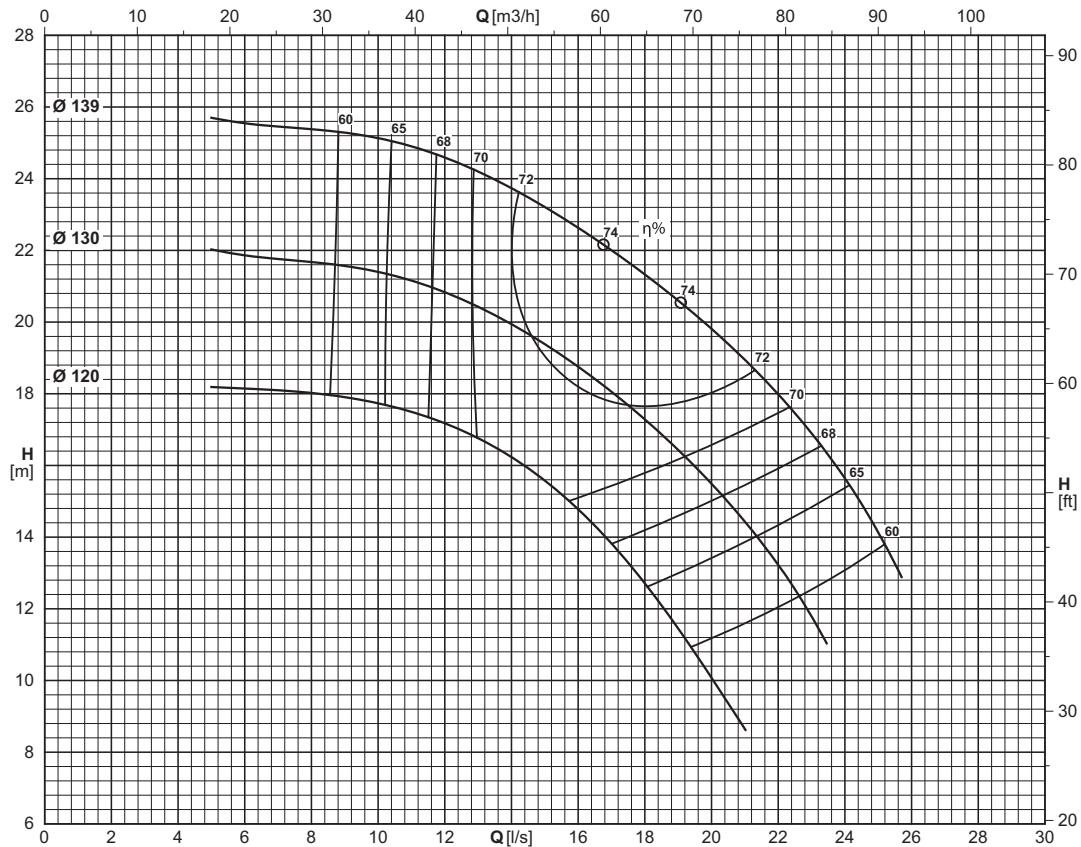

Type Type Tipo	Inlet maximum pressure (*) Pression maximale en aspiration (*) Pressione massima in aspirazione (*)	Dynamic momentum J Momentum dynamique J Momento dinamico J	
		With cast iron impellers Avec roues en fonte Con giranti in ghisa	With AISI 316 impellers Avec roues en AISI 316 Con giranti in AISI 316
		J = 1/4 PD <sup>2</sup>	
	[bar]	[kgm <sup>2</sup> ]	
NC50-125	6	0,0036977	(F) 0,0042259

Construction reference standard EN733 (DIN24255)  
(\*) Value referred to the impeller with maximum diameter.

Norme de référence construction EN733 (DIN24255)  
(\*) Valeur se référant à la roue à ailettes avec le diamètre maximum.

Norma di riferimento costruttivo EN733 (DIN24255)  
(\*) Valore riferito alla girante con diametro massimo.



Operating data  
 Caracteristiques de fonctionnement  
 Caratteristiche di funzionamento

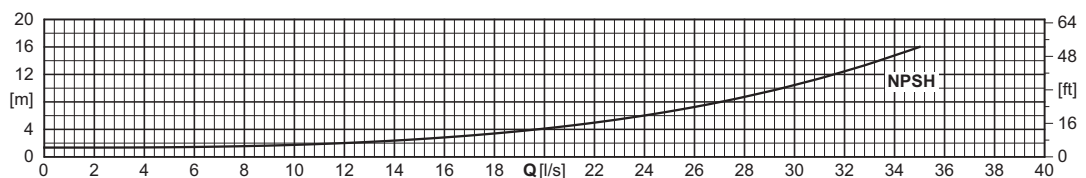
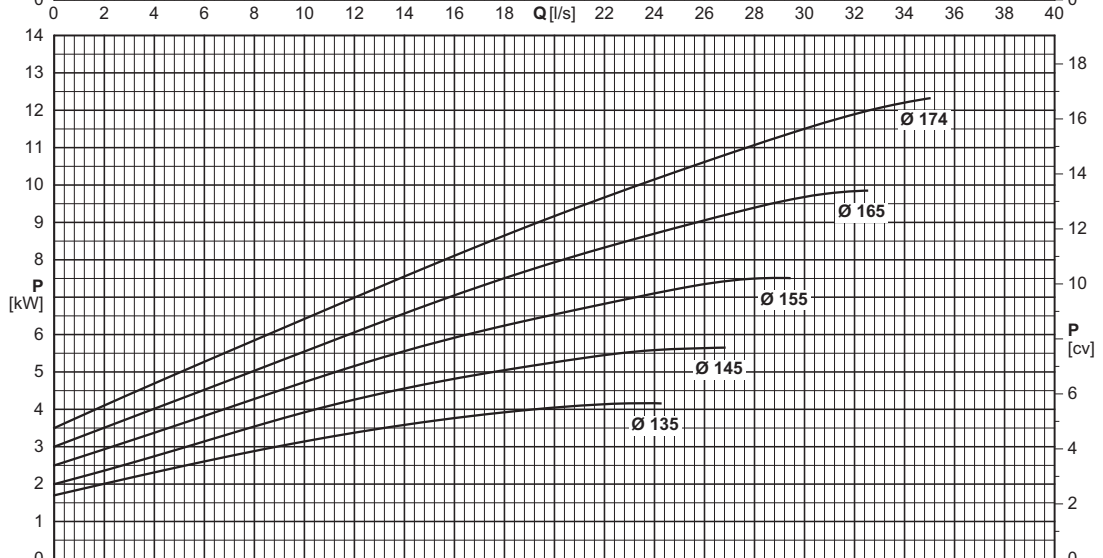
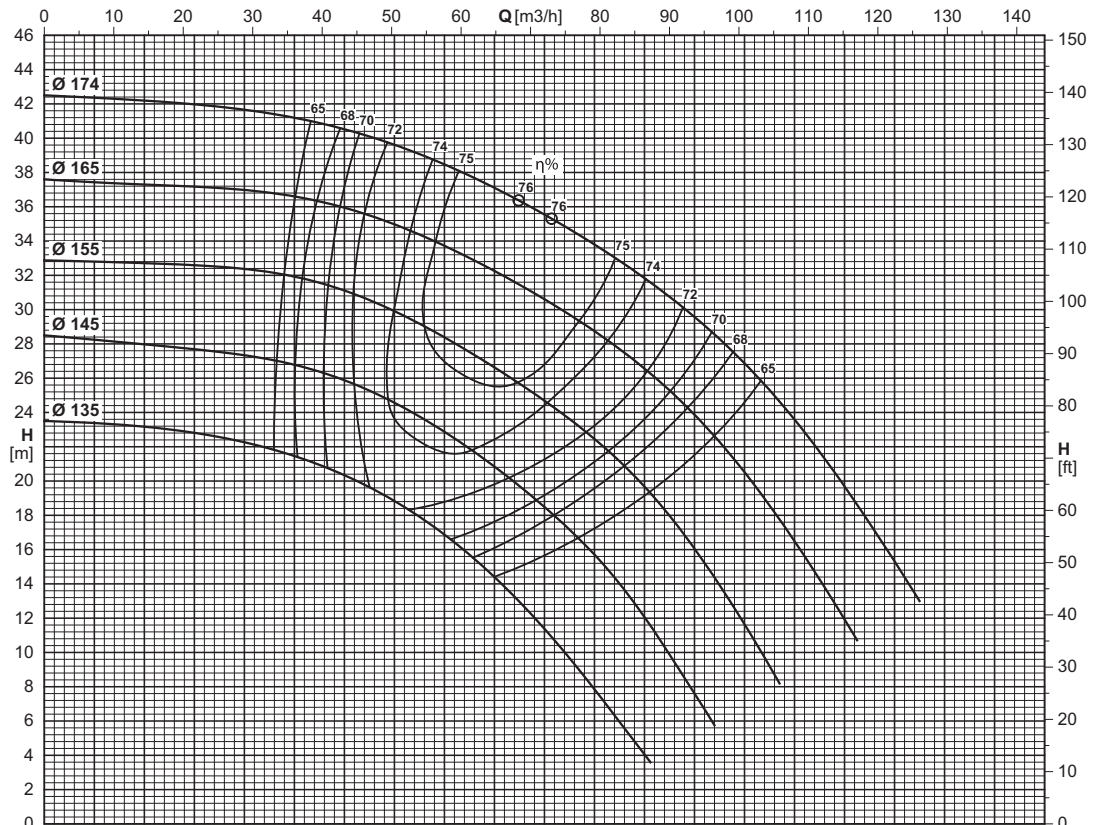

Type Type Tipo	Inlet maximum pressure (*) Pression maximale en aspiration (*) Pressione massima in aspirazione (*)	Dynamic momentum J Momentum dynamique J Momento dinamico J	
		With cast iron impellers Avec roues en fonte Con giranti in ghisa	With AISI 316 impellers Avec roues en AISI 316 Con giranti in AISI 316
		$J = \frac{1}{2}PD^2$	
	[bar]	[kgm <sup>2</sup> ]	
NC50-160	4	0,0066337	(F) 0,0075814

Construction reference standard EN733 (DIN24255)  
 (\*) Value referred to the impeller with maximum diameter.

Norme de référence construction EN733 (DIN24255)  
 (\*) Valeur se référant à la roue à ailettes avec le diamètre maximum.

Norma di riferimento costruttivo EN733 (DIN24255)  
 (\*) Valore riferito alla girante con diametro massimo.

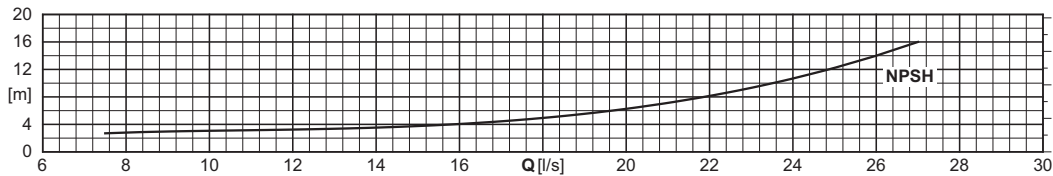
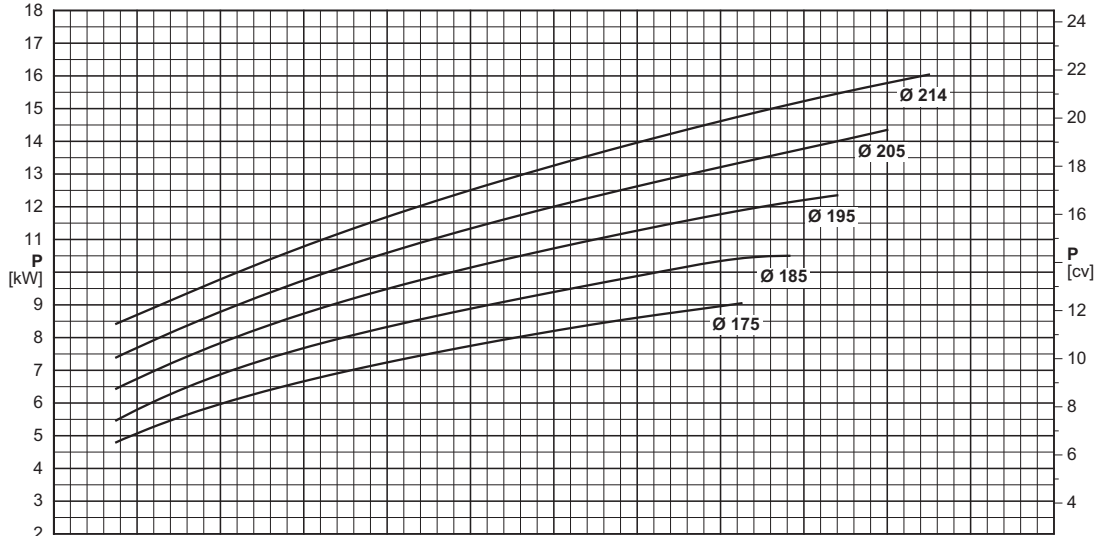
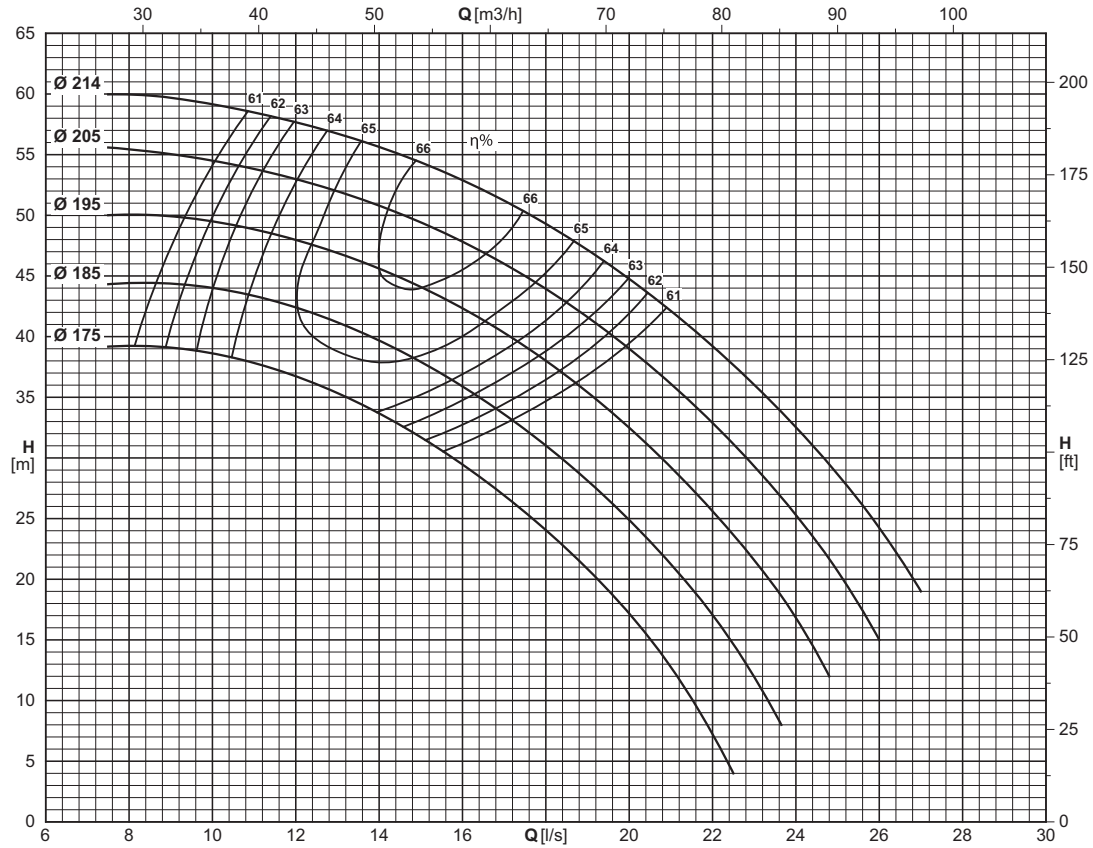

Type Type Tipo	Inlet maximum pressure (*) Pression maximale en aspiration (*) Pressione massima in aspirazione (*)	Dynamic momentum J Momentum dynamique J Momento dinamico J	
		With cast iron impellers Avec roues en fonte Con giranti in ghisa	With AISI 316 impellers Avec roues en AISI 316 Con giranti in AISI 316
		J=1/4PD <sup>2</sup>	
	[bar]	[kgm <sup>2</sup> ]	[kgm <sup>2</sup> ]
NC50-200	2	0,0158799	(F) 0,0181484

Construction reference standard EN733 (DIN24255)  
(\*) Value referred to the impeller with maximum diameter.

Norme de référence construction EN733 (DIN24255)  
(\*) Valeur se référant à la roue à ailettes avec le diamètre maximum.

Norma di riferimento costruttivo EN733 (DIN24255)  
(\*) Valore riferito alla girante con diametro massimo.

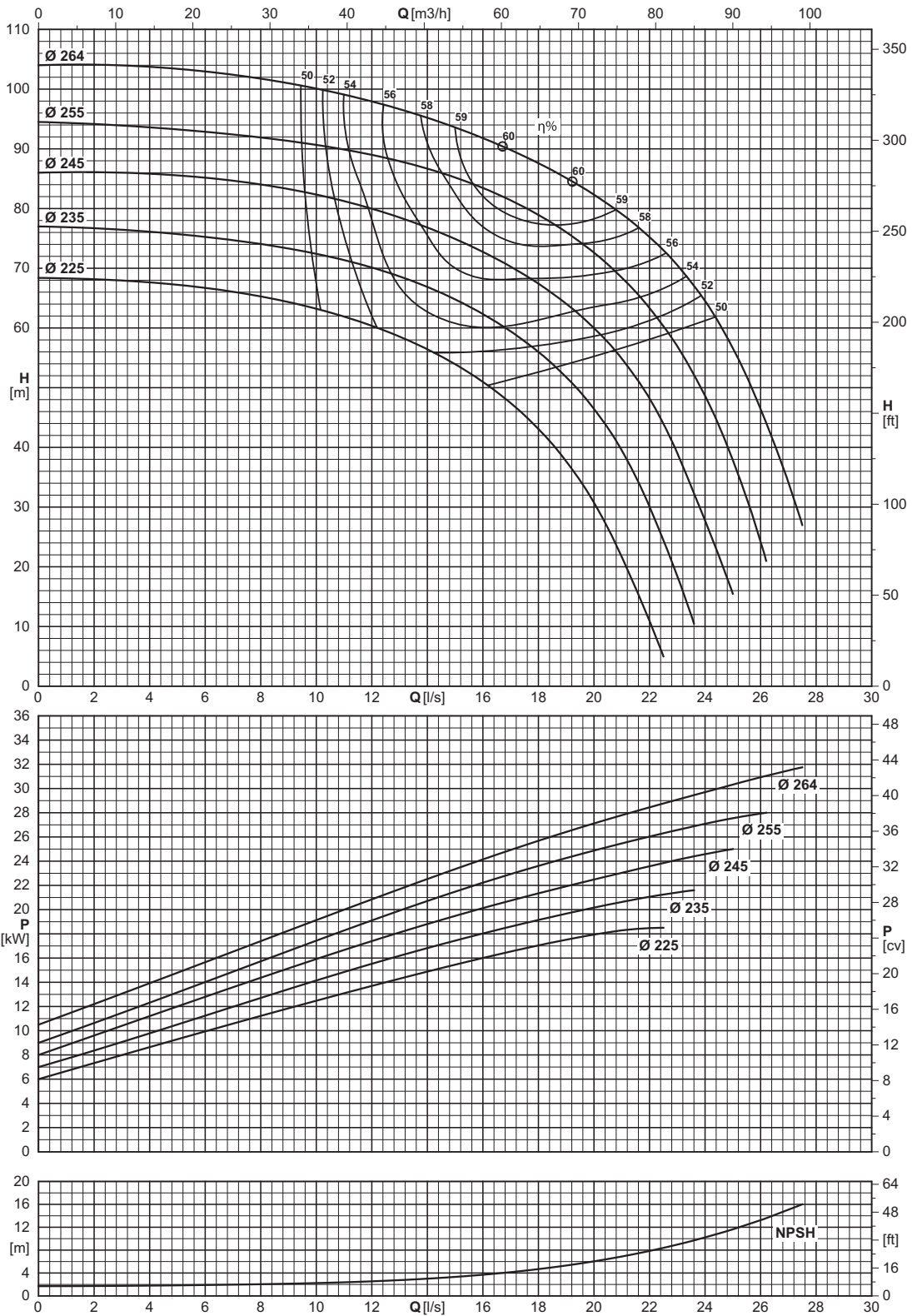

Type Type Tipo	Inlet maximum pressure (*) Pression maximale en aspiration (*) Pressione massima in aspirazione (*)	Dynamic momentum J Momentum dynamique J Momento dinamico J	
		With cast iron impellers Avec roues en fonte Con giranti in ghisa	With AISI 316 impellers Avec roues en AISI 316 Con giranti in AISI 316
		J=1/4PD²	
	[bar]	[kgm²]	[kgm²]
NC50-250	0	0,0385528	(F) 0,0440603

Construction reference standard EN733 (DIN24255)  
(\*) Value referred to the impeller with maximum diameter.

Norme de référence construction EN733 (DIN24255)  
(\*) Valeur se référant à la roue à ailettes avec le diamètre maximum.

Norma di riferimento costruttivo EN733 (DIN24255)  
(\*) Valore riferito alla girante con diametro massimo.

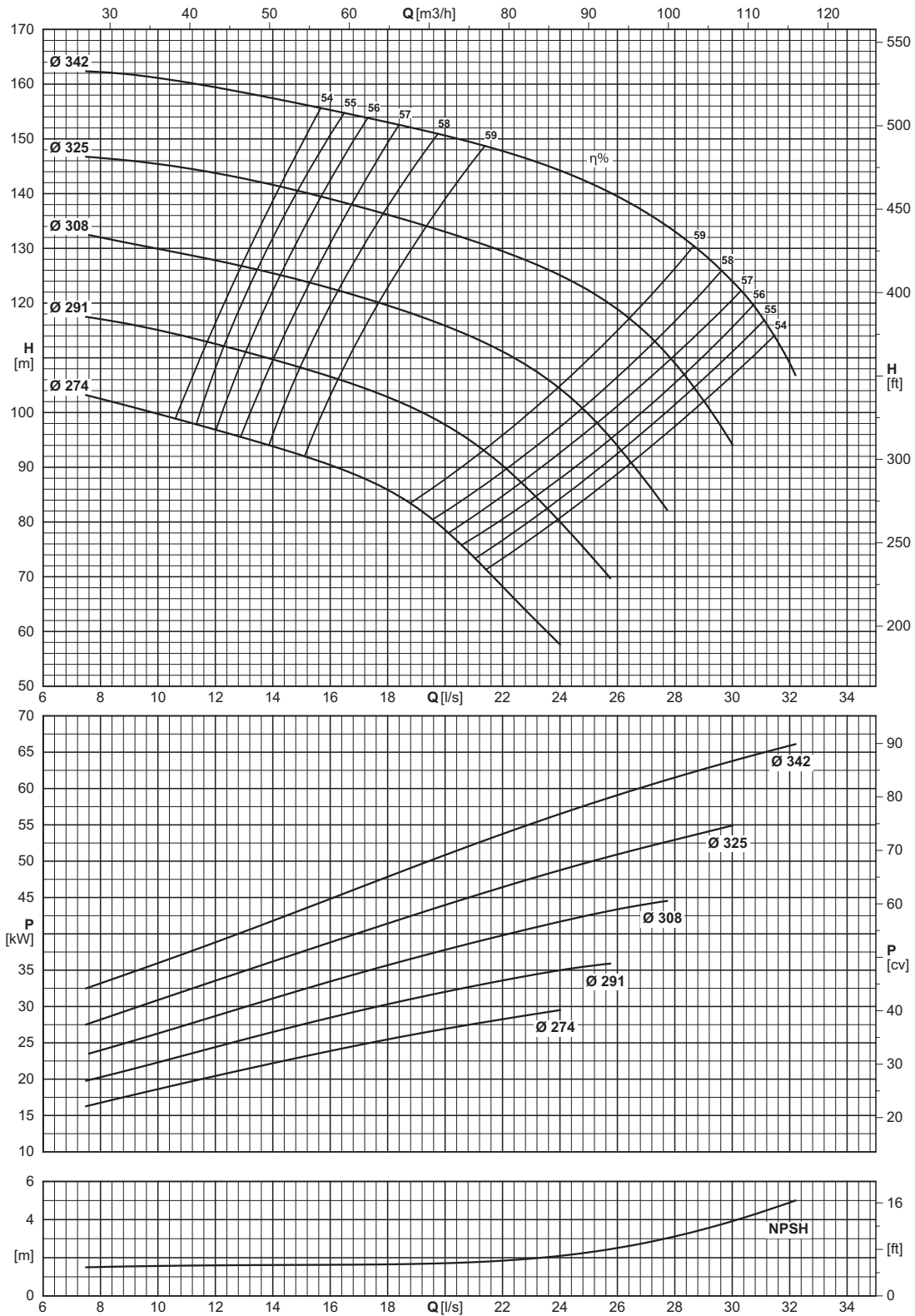

Type Type Tipo	Inlet maximum pressure (*) Pression maximale en aspiration (*) Pressione massima in aspirazione (*)	Dynamic momentum J Momentum dynamique J Momento dinamico J	
		With cast iron impellers Avec roues en fonte Con giranti in ghisa	With AISI 316 impellers Avec roues en AISI 316 Con giranti in AISI 316
		J = 1/4 PD <sup>2</sup>	
[bar]		[kgm <sup>2</sup> ]	
NCH50-315	8	0,147485	(F) 0,1685543

(\*) Value referred to the impeller with maximum diameter.

(\*) Valeur se référant à la roue à ailettes avec le diamètre maximum. (\*) Valore riferito alla girante con diametro massimo.

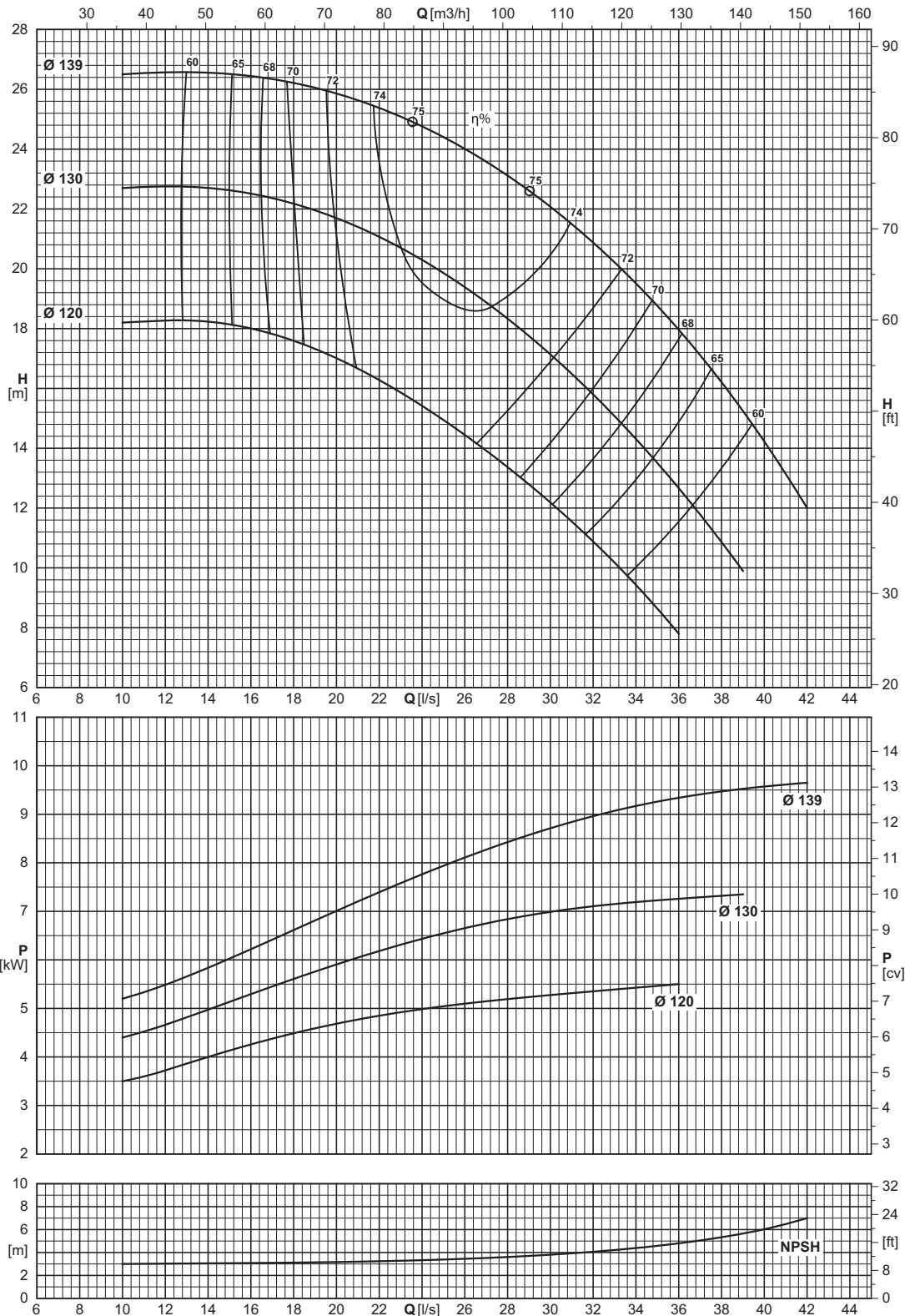

Type Type Tipo	Inlet maximum pressure (*) Pression maximale en aspiration (*) Pressione massima in aspirazione (*)	Dynamic momentum J Momentum dynamique J Momento dinamico J	
		With cast iron impellers Avec roues en fonte Con giranti in ghisa	With AISI 316 impellers Avec roues en AISI 316 Con giranti in AISI 316
		J = 1/4 PD <sup>2</sup>	
	[bar]	[kgm <sup>2</sup> ]	[kgm <sup>2</sup> ]
NC65-125	6	0,0044372	(F) 0,0050711

Construction reference standard EN733 (DIN24255)  
(\*) Value referred to the impeller with maximum diameter.

Norme de référence construction EN733 (DIN24255)  
(\*) Valeur se référant à la roue à ailettes avec le diamètre maximum.

Norma di riferimento costruttivo EN733 (DIN24255)  
(\*) Valore riferito alla girante con diametro massimo.

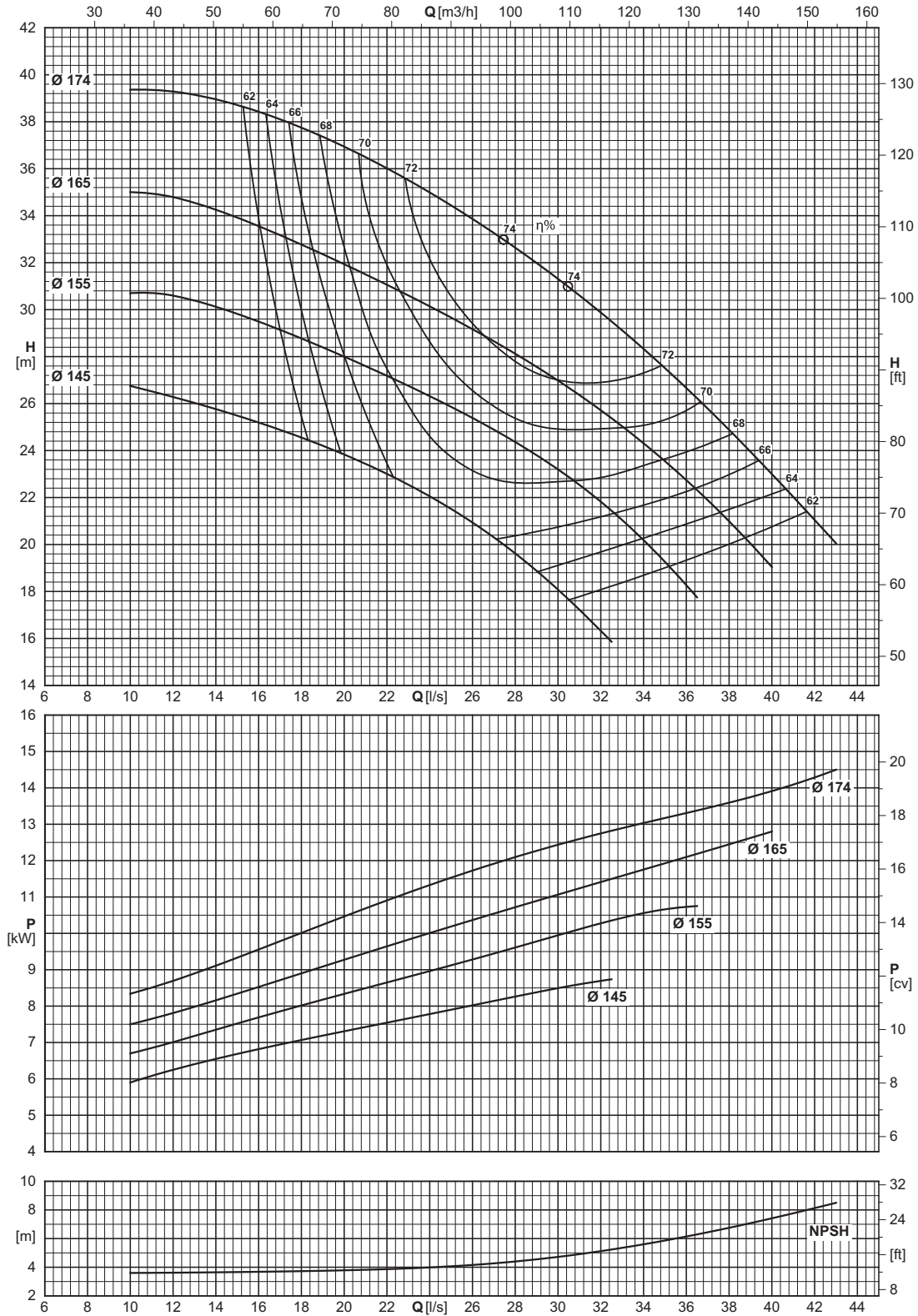

Type Type Tipo	Inlet maximum pressure (*) Pression maximale en aspiration (*) Pressione massima in aspirazione (*)	Dynamic momentum J Momentum dynamique J Momento dinamico J	
		With cast iron impellers Avec roues en fonte Con giranti in ghisa	With AISI 316 impellers Avec roues en AISI 316 Con giranti in AISI 316
		J = 1/4 PD <sup>2</sup>	
[bar]		[kgm <sup>2</sup> ]	
NC65-160	5	0,0078607	(F) 0,0089837

Construction reference standard EN733 (DIN24255)  
(\*) Value referred to the impeller with maximum diameter.

Norme de référence construction EN733 (DIN24255)  
(\*) Valeur se référant à la roue à ailettes avec le diamètre maximum.

Norma di riferimento costruttivo EN733 (DIN24255)  
(\*) Valore riferito alla girante con diametro massimo.

Operating data  
 Caracteristiques de fonctionnement  
 Caratteristiche di funzionamento

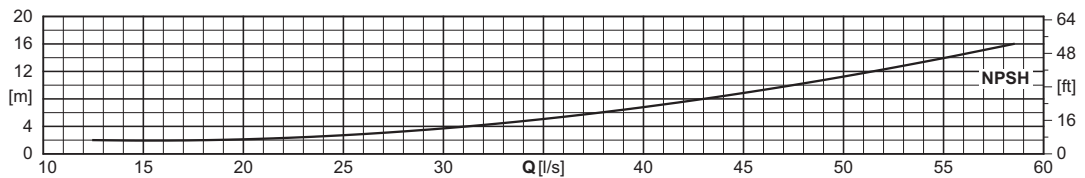
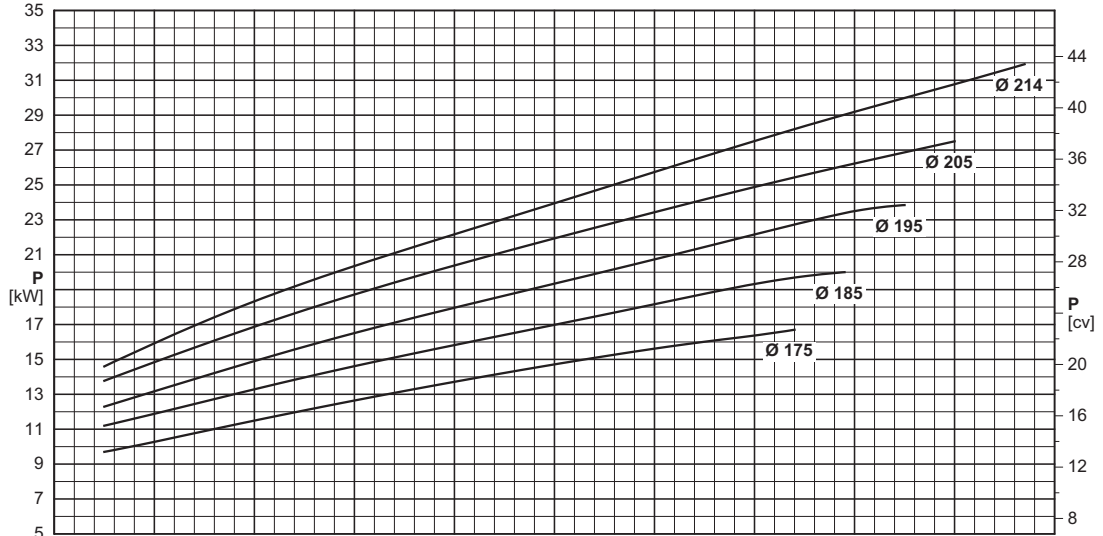
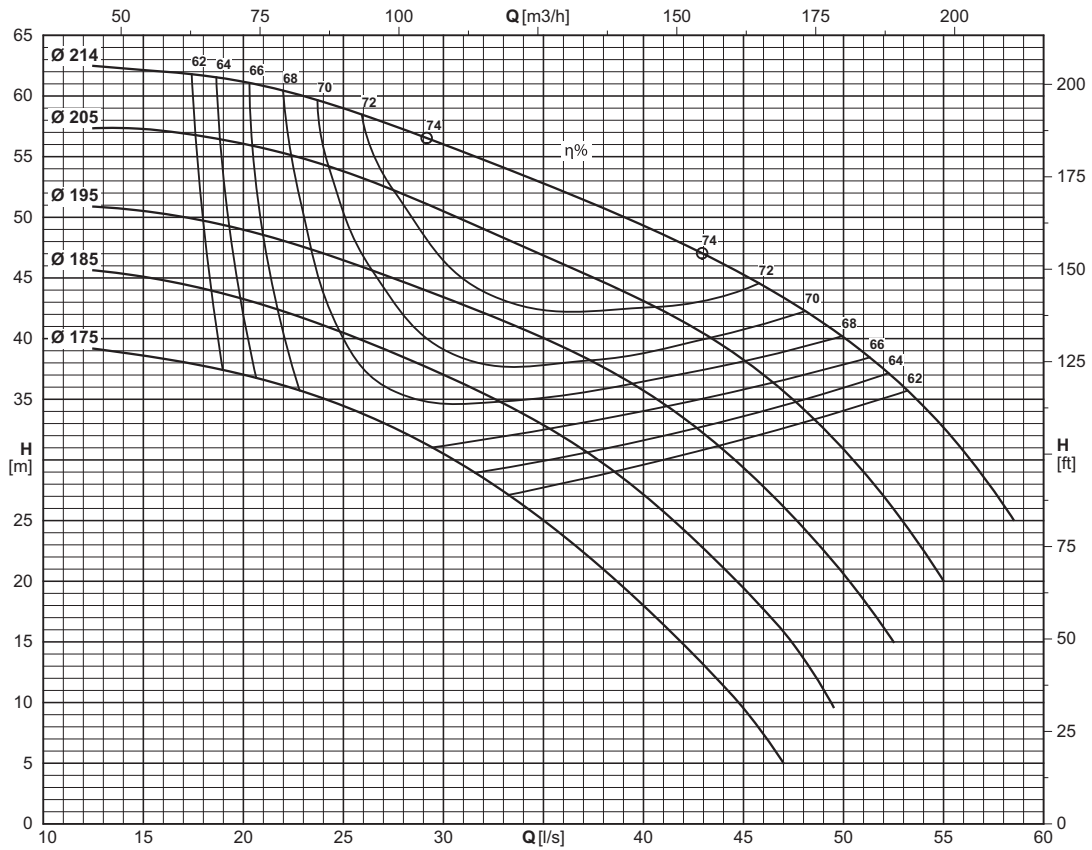

Type Type Tipo	Inlet maximum pressure (*) Pression maximale en aspiration (*) Pressione massima in aspirazione (*)	Dynamic momentum J Momentum dynamique J Momento dinamico J	
		With cast iron impellers Avec roues en fonte Con giranti in ghisa	With AISI 316 impellers Avec roues en AISI 316 Con giranti in AISI 316
		$J = \frac{1}{2}PD^2$	
[bar]		[kgm <sup>2</sup> ]	
NC65-200	2	0,0158799	(F) 0,0181484

Construction reference standard EN733 (DIN24255)  
 (\*) Value referred to the impeller with maximum diameter.

Norme de référence construction EN733 (DIN24255)  
 (\*) Valeur se référant à la roue à ailettes avec le diamètre maximum.

Norma di riferimento costruttivo EN733 (DIN24255)  
 (\*) Valore riferito alla girante con diametro massimo.

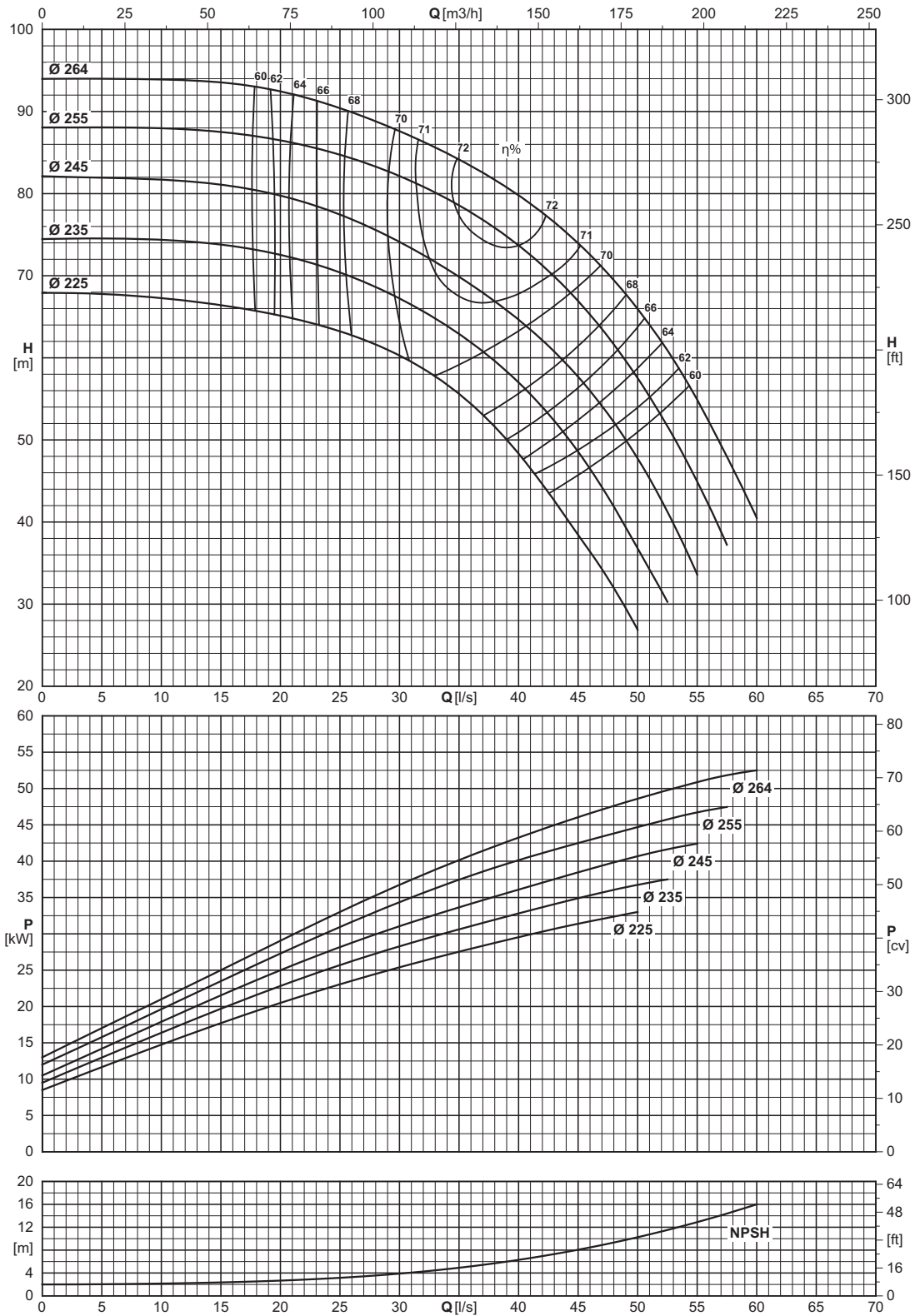

Type Type Tipo	Inlet maximum pressure (*) Pression maximale en aspiration (*) Pressione massima in aspirazione (*)	Dinamic momentum J Momentum dynamique J Momento dinamico J	
		With cast iron impellers Avec roues en fonte Con giranti in ghisa	With AISI 316 impellers Avec roues en AISI 316 Con giranti in AISI 316
		J = 1/4 PD²	
	[bar]	[kgm²]	[kgm²]
NC65-250	0	0,04405	(F) 0,0503429

Construction reference standard EN733 (DIN24255)  
(\*) Value referred to the impeller with maximum diameter.

Norme de référence construction EN733 (DIN24255)  
(\*) Valeur se référant à la roue à ailettes avec le diamètre maximum.

Norma di riferimento costruttivo EN733 (DIN24255)  
(\*) Valore riferito alla girante con diametro massimo.



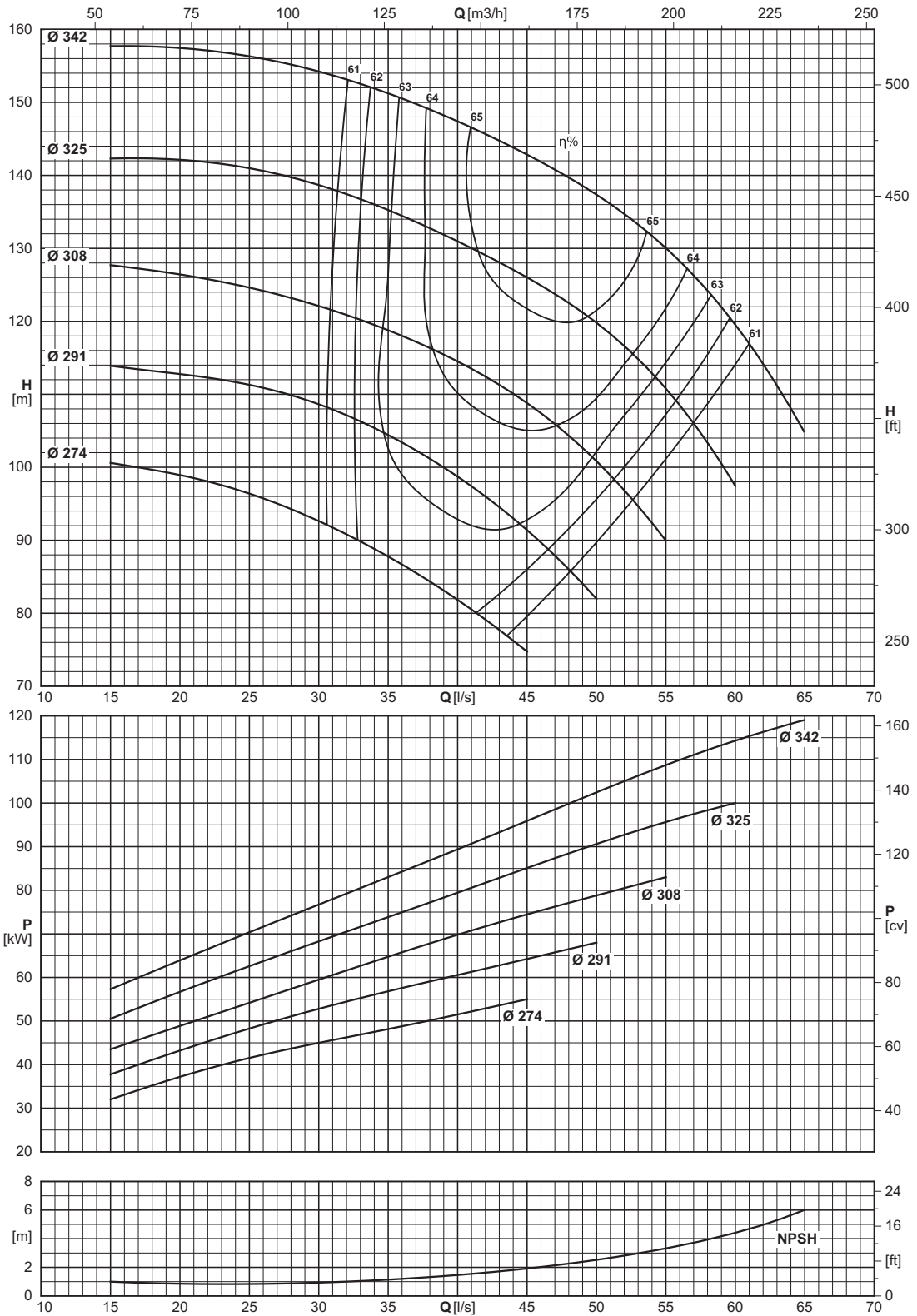

Type Type Tipo	Inlet maximum pressure (*) Pression maximale en aspiration (*) Pressione massima in aspirazione (*)	Dynamic momentum J Momentum dynamique J Momento dinamico J	
		With cast iron impellers Avec roues en fonte Con giranti in ghisa	With AISI 316 impellers Avec roues en AISI 316 Con giranti in AISI 316
		J = 1/4 PD <sup>2</sup>	
	[bar]	[kgm <sup>2</sup> ]	[kgm <sup>2</sup> ]
NCH65-315	0	0,1630808	(F) 0,1863781

(\*) Value referred to the impeller with maximum diameter.

(\*) Valeur se référant à la roue à ailettes avec le diamètre maximum. (\*) Valore riferito alla girante con diametro massimo.

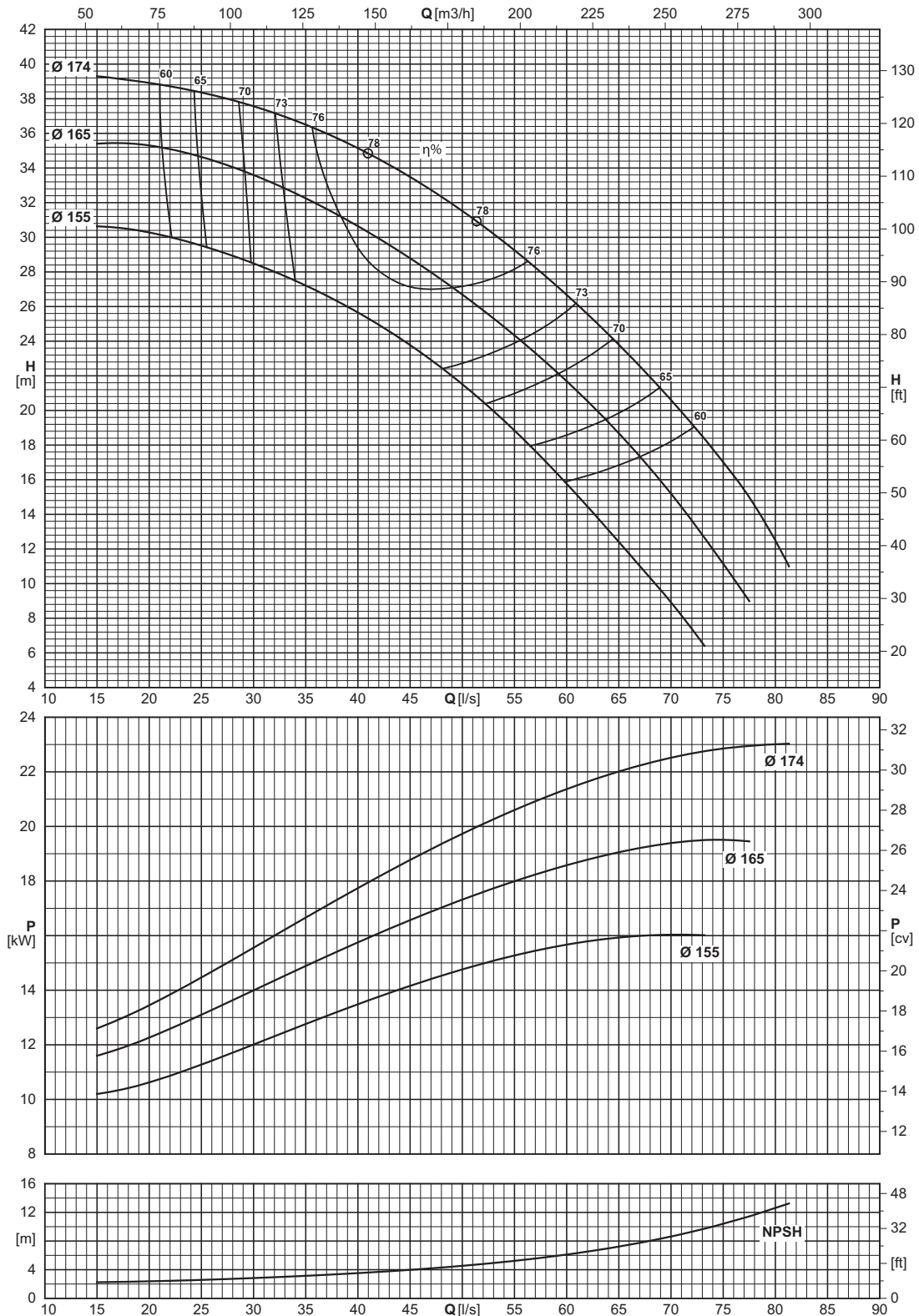

Type Type Tipo	Inlet maximum pressure (*) Pression maximale en aspiration (*) Pressione massima in aspirazione (*)	Dinamic momentum J Momentum dynamique J Momento dinamico J	
		With cast iron impellers Avec roues en fonte Con giranti in ghisa	With AISI 316 impellers Avec roues en AISI 316 Con giranti in AISI 316
		J = 1/4 PD <sup>2</sup>	
[bar]		[kgm <sup>2</sup> ]	
NC80-160	5	0,0103532	(F) 0,0118322

Construction reference standard EN733 (DIN24255)      Norme de référence construction EN733 (DIN24255)      Norma di riferimento costruttivo EN733 (DIN24255)  
 (\*) Value referred to the impeller with maximum diameter.      (\*) Valeur se référant à la roue à ailettes avec le diamètre maximum.      (\*) Valore riferito alla girante con diametro massimo.

Operating data  
 Caracteristiques de fonctionnement  
 Caratteristiche di funzionamento

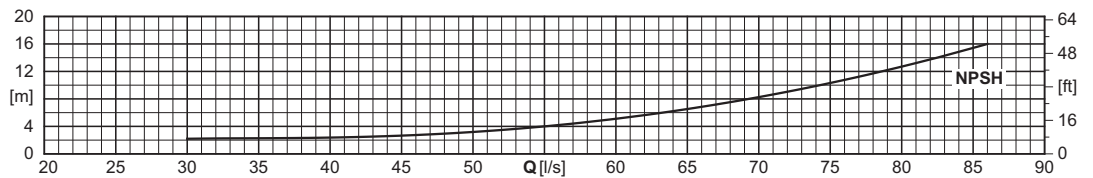
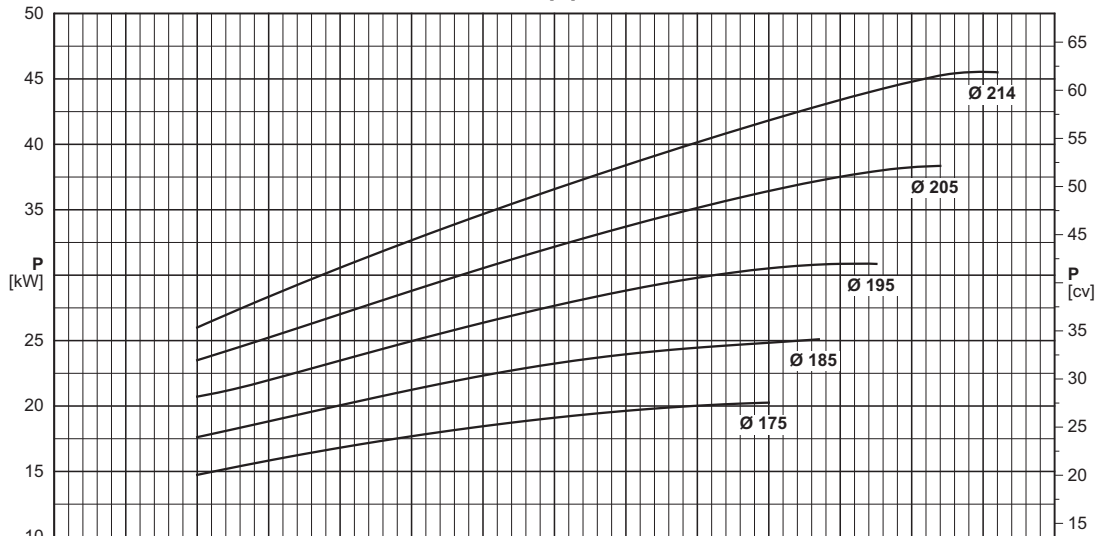
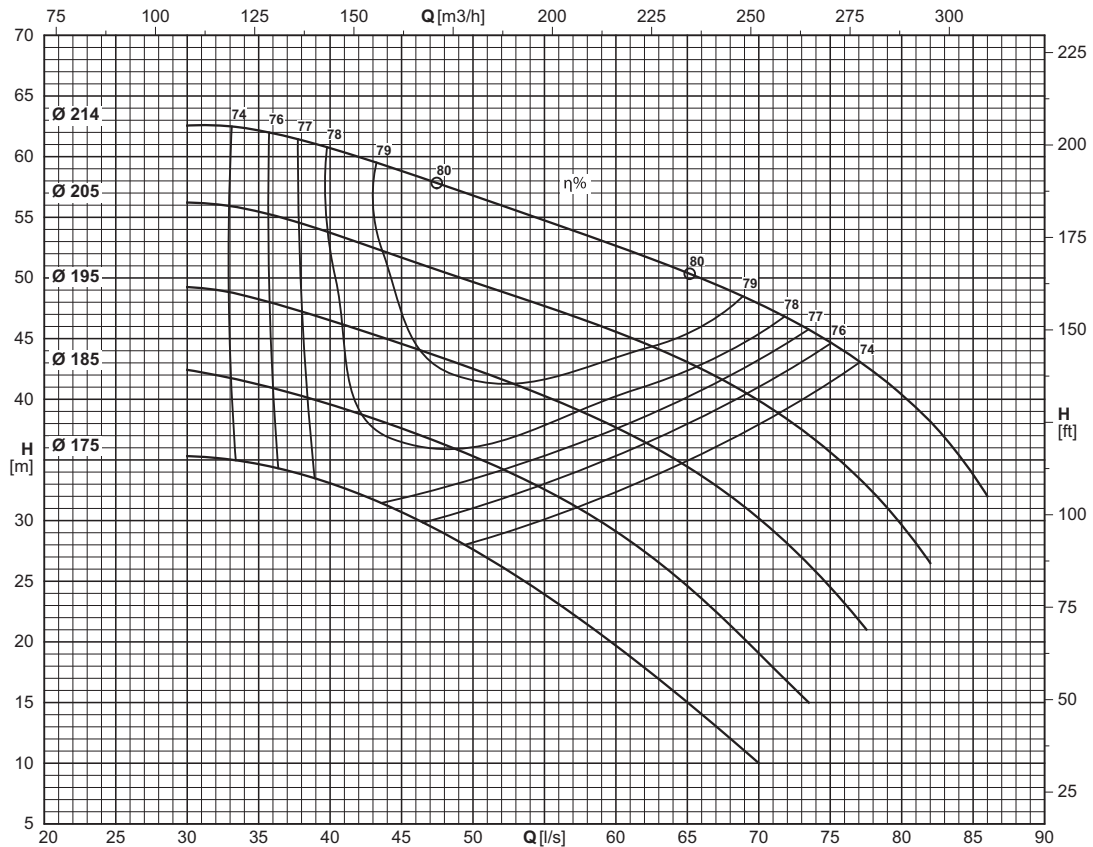

Type Type Tipo	Inlet maximum pressure (*) Pression maximale en aspiration (*) Pressione massima in aspirazione (*)	Dynamic momentum J Momentum dynamique J Momento dinamico J	
		With cast iron impellers Avec roues en fonte Con giranti in ghisa	With AISI 316 impellers Avec roues en AISI 316 Con giranti in AISI 316
		J = 1/4 PD <sup>2</sup>	
[bar]		[kgm <sup>2</sup> ]	
NC80-200	2	0,0203788	(F) 0,023329

Construction reference standard EN733 (DIN24255)  
 (\*) Value referred to the impeller with maximum diameter.

Norme de référence construction EN733 (DIN24255)  
 (\*) Valeur se référant à la roue à ailettes avec le diamètre maximum.

Norma di riferimento costruttivo EN733 (DIN24255)  
 (\*) Valore riferito alla girante con diametro massimo.

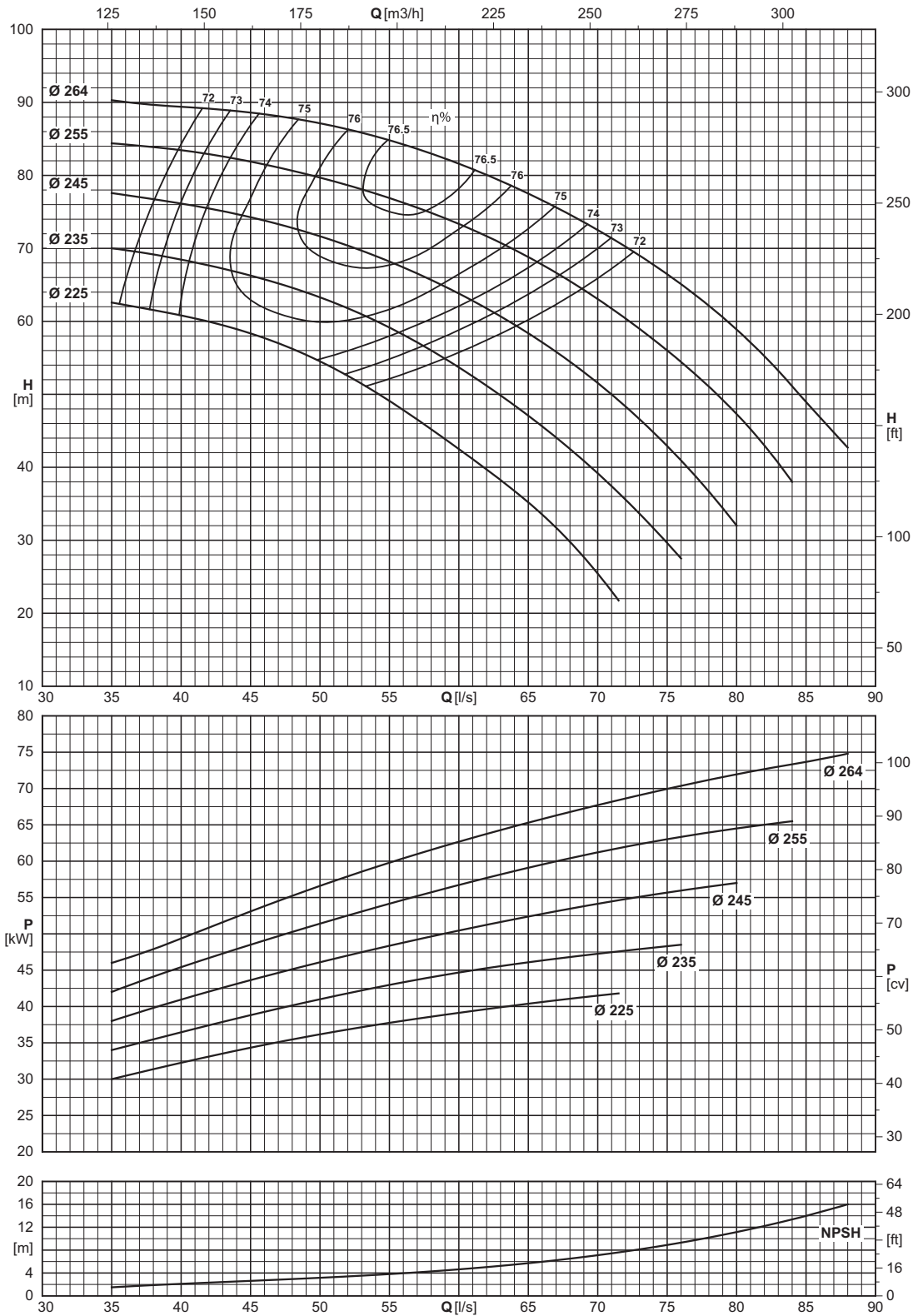

Type Type Tipo	Inlet maximum pressure (*) Pression maximale en aspiration (*) Pressione massima in aspirazione (*)	Dinamic momentum J Momentum dynamique J Momento dinamico J	
		With cast iron impellers Avec roues en fonte Con giranti in ghisa	With AISI 316 impellers Avec roues en AISI 316 Con giranti in AISI 316
		J = 1/4 PD <sup>2</sup>	
[bar]		[kgm <sup>2</sup> ]	
NC80-250	0	0,0427285	(F) 0,0488326

Construction reference standard EN733 (DIN24255)  
(\*) Value referred to the impeller with maximum diameter.

Norme de référence construction EN733 (DIN24255)  
(\*) Valeur se référant à la roue à ailettes avec le diamètre maximum.

Norma di riferimento costruttivo EN733 (DIN24255)  
(\*) Valore riferito alla girante con diametro massimo.

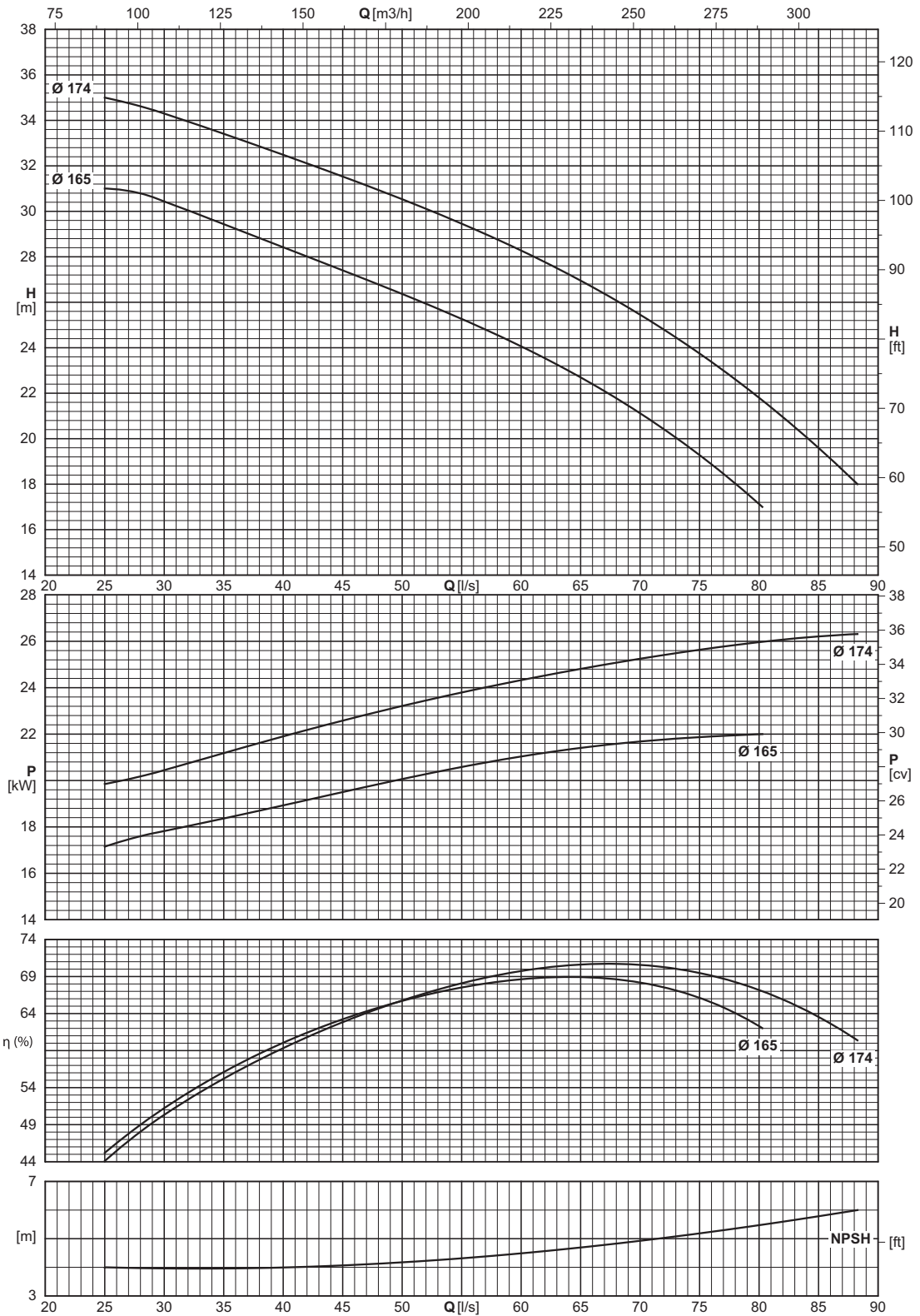

Type Type Tipo	Inlet maximum pressure (*) Pression maximale en aspiration (*) Pressione massima in aspirazione (*)	Dynamic momentum J Momentum dynamique J Momento dinamico J	
		With cast iron impellers Avec roues en fonte Con giranti in ghisa	With AISI 316 impellers Avec roues en AISI 316 Con giranti in AISI 316
		$J = \frac{1}{2}PD^2$	
	[bar]	[kgm <sup>2</sup> ]	
NC100-160	5	0,0116475	(F) 0,0133114

Construction reference standard EN733 (DIN24255)  
 (\*) Value referred to the impeller with maximum diameter.

Norme de référence construction EN733 (DIN24255)  
 (\*) Valeur se référant à la roue à ailettes avec le diamètre maximum.

Norma di riferimento costruttivo EN733 (DIN24255)  
 (\*) Valore riferito alla girante con diametro massimo.

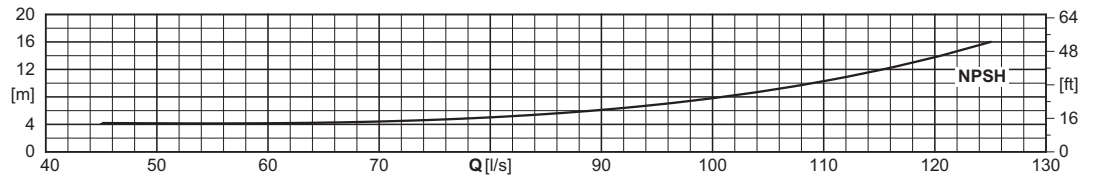
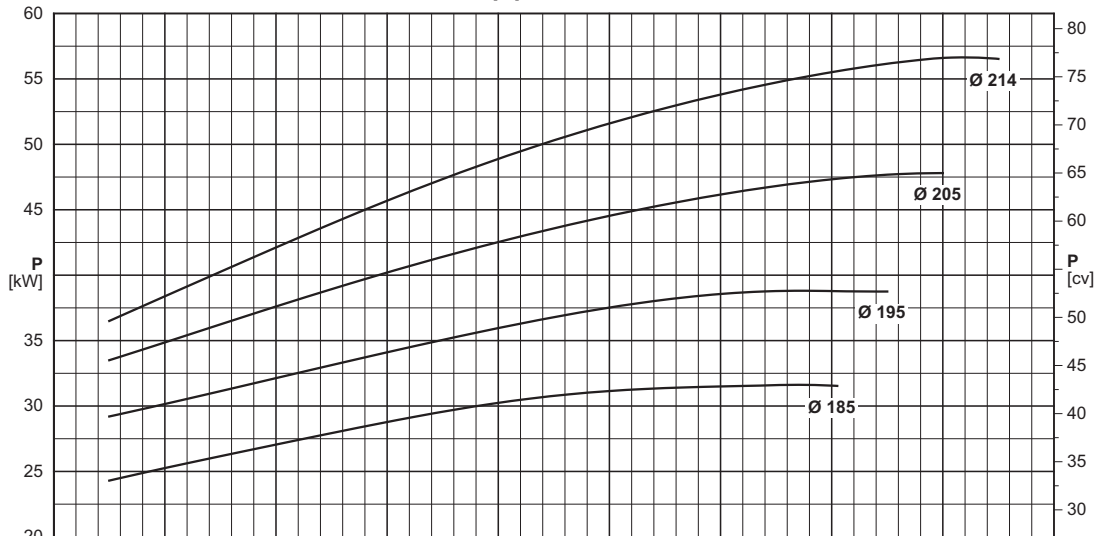
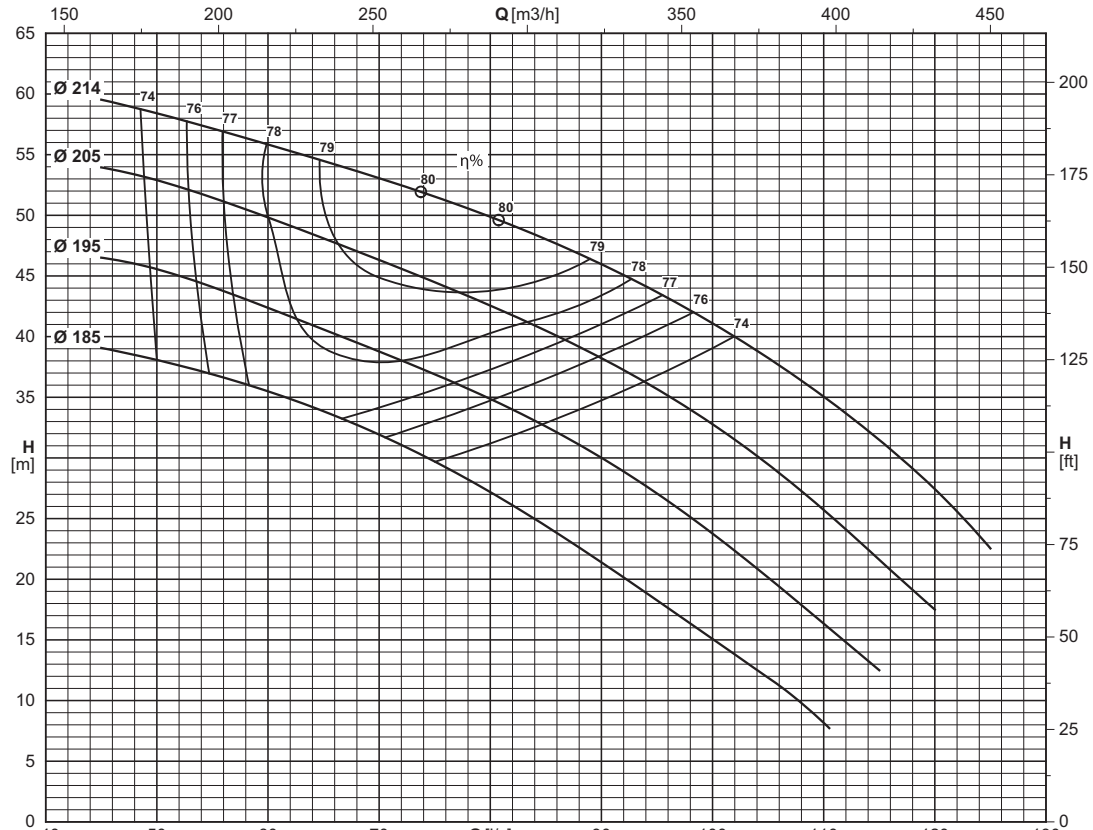

Type Type Tipo	Inlet maximum pressure (*) Pression maximale en aspiration (*) Pressione massima in aspirazione (*)	Dynamic momentum J Momentum dynamique J Momento dinamico J	
		With cast iron impellers Avec roues en fonte Con giranti in ghisa	With AISI 316 impellers Avec roues en AISI 316 Con giranti in AISI 316
		J = 1/4 PD <sup>2</sup>	
[bar]		[kgm <sup>2</sup> ]	
NC100-200	3	0,0247456	(F) 0,0282807

Construction reference standard EN733 (DIN24255)  
 (\*) Value referred to the impeller with maximum diameter.

Norme de référence construction EN733 (DIN24255)  
 (\*) Valeur se référant à la roue à ailettes avec le diamètre maximum.

Norma di riferimento costruttivo EN733 (DIN24255)  
 (\*) Valore riferito alla girante con diametro massimo.

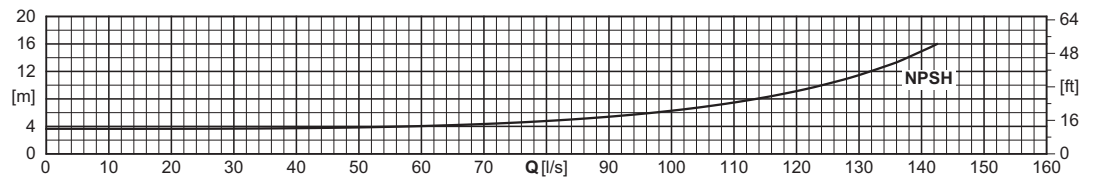
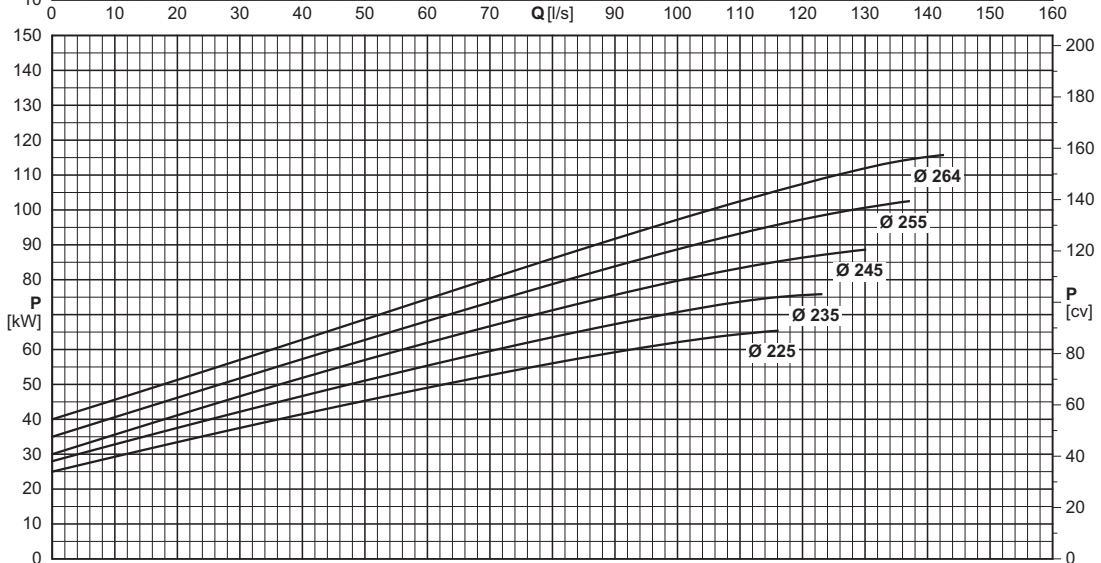
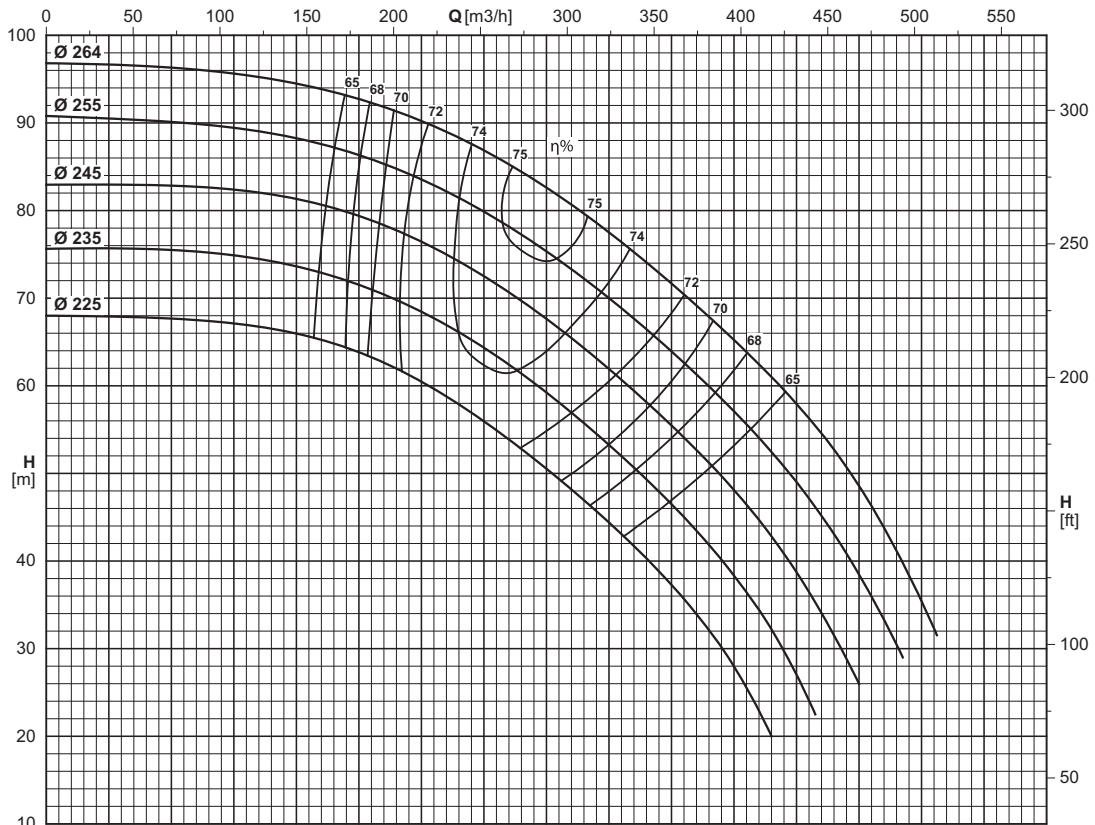

Type Type Tipo	Inlet maximum pressure (*) Pression maximale en aspiration (*) Pressione massima in aspirazione (*)	Dynamic momentum J Momentum dynamique J Momento dinamico J	
		With cast iron impellers Avec roues en fonte Con giranti in ghisa	With AISI 316 impellers Avec roues en AISI 316 Con giranti in AISI 316
		$J = \frac{1}{2}PD^2$	
	[bar]	[kgm <sup>2</sup> ]	
NC100-250	0	0,057265	(F) 0,0654457

Construction reference standard EN733 (DIN24255)  
 (\*) Value referred to the impeller with maximum diameter.

Norme di riferimento costruttivo EN733 (DIN24255)  
 (\*) Valeur se référant à la roue à ailettes avec le diamètre maximum.

Norma di riferimento costruttivo EN733 (DIN24255)  
 (\*) Valore riferito alla girante con diametro massimo.

# NCH 100-315

2900 n [min<sup>-1</sup>]



Operating data  
Caracteristiques de fonctionnement  
Caratteristiche di funzionamento

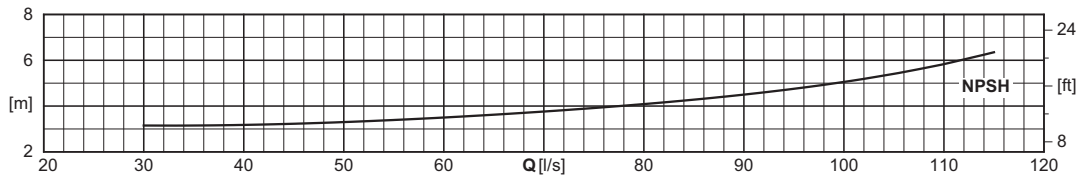
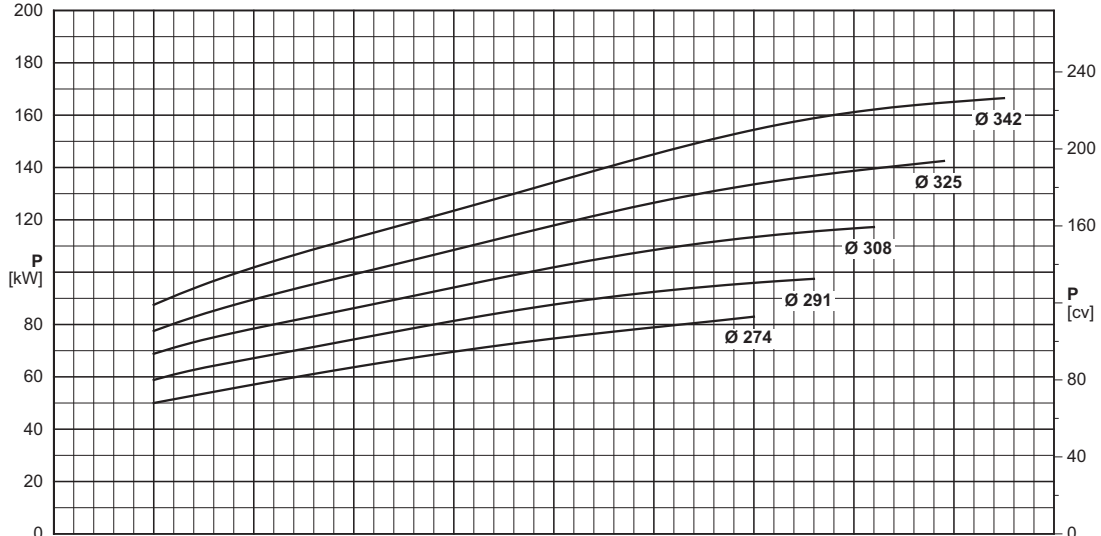
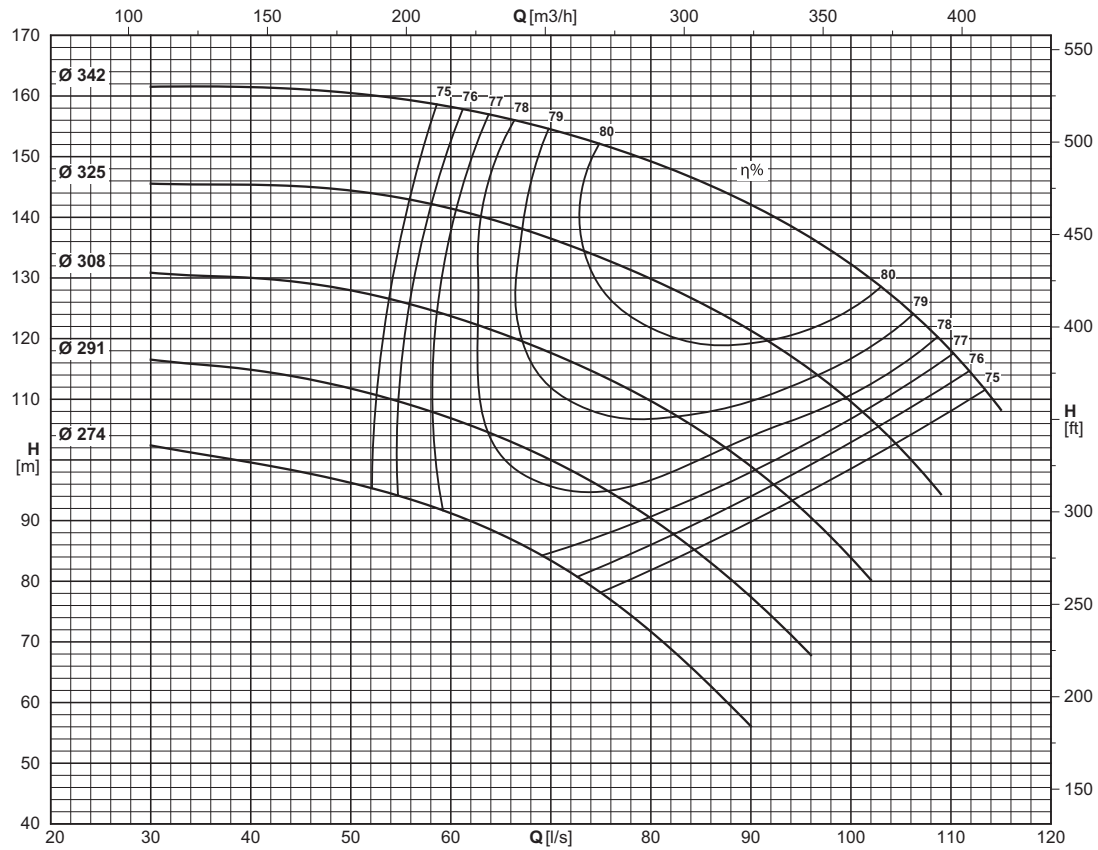

Type Type Tipo	Inlet maximum pressure (*) Pression maximale en aspiration (*) Pressione massima in aspirazione (*)	Dynamic momentum J Momentum dynamique J Momento dinamico J	
		With cast iron impellers Avec roues en fonte Con giranti in ghisa	With AISI 316 impellers Avec roues en AISI 316 Con giranti in AISI 316
		J = 1/4 PD <sup>2</sup>	
[bar]		[kgm <sup>2</sup> ]	
NCH100-315	0	0,1779064	(F) 0,2033216

(\*) Value referred to the impeller with maximum diameter.

(\*) Valeur se référant à la roue à ailettes avec le diamètre maximum. (\*) Valore riferito alla girante con diametro massimo.



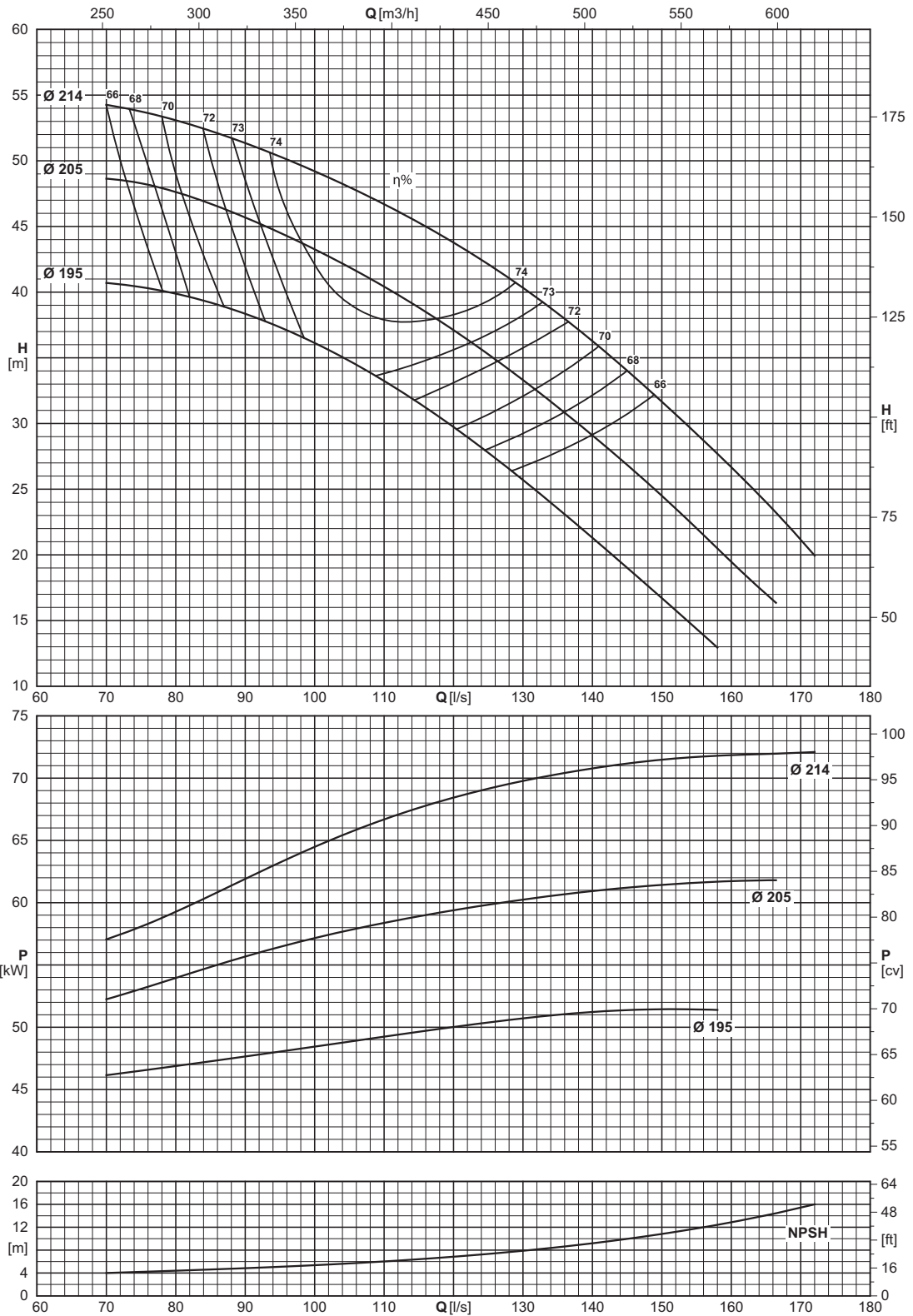

Type Type Tipo	Inlet maximum pressure (*) Pression maximale en aspiration (*) Pressione massima in aspirazione (*)	Dynamic momentum J Momentum dynamique J Momento dinamico J	
		With cast iron impellers Avec roues en fonte Con giranti in ghisa	With AISI 316 impellers Avec roues en AISI 316 Con giranti in AISI 316
		J = 1/4 PD <sup>2</sup>	
	[bar]	[kgm <sup>2</sup> ]	[kgm <sup>2</sup> ]
NC125-200	3	0,0291125	(F) 0,0332714

Construction reference standard EN733 (DIN24255)  
 (\*) Value referred to the impeller with maximum diameter.

Norme de référence construction EN733 (DIN24255)  
 (\*) Valeur se référant à la roue à ailettes avec le diamètre maximum.

Norma di riferimento costruttivo EN733 (DIN24255)  
 (\*) Valore riferito alla girante con diametro massimo.

# NCH 125-250

2900 n [min<sup>-1</sup>]



Operating data  
Caracteristiques de fonctionnement  
Caratteristiche di funzionamento

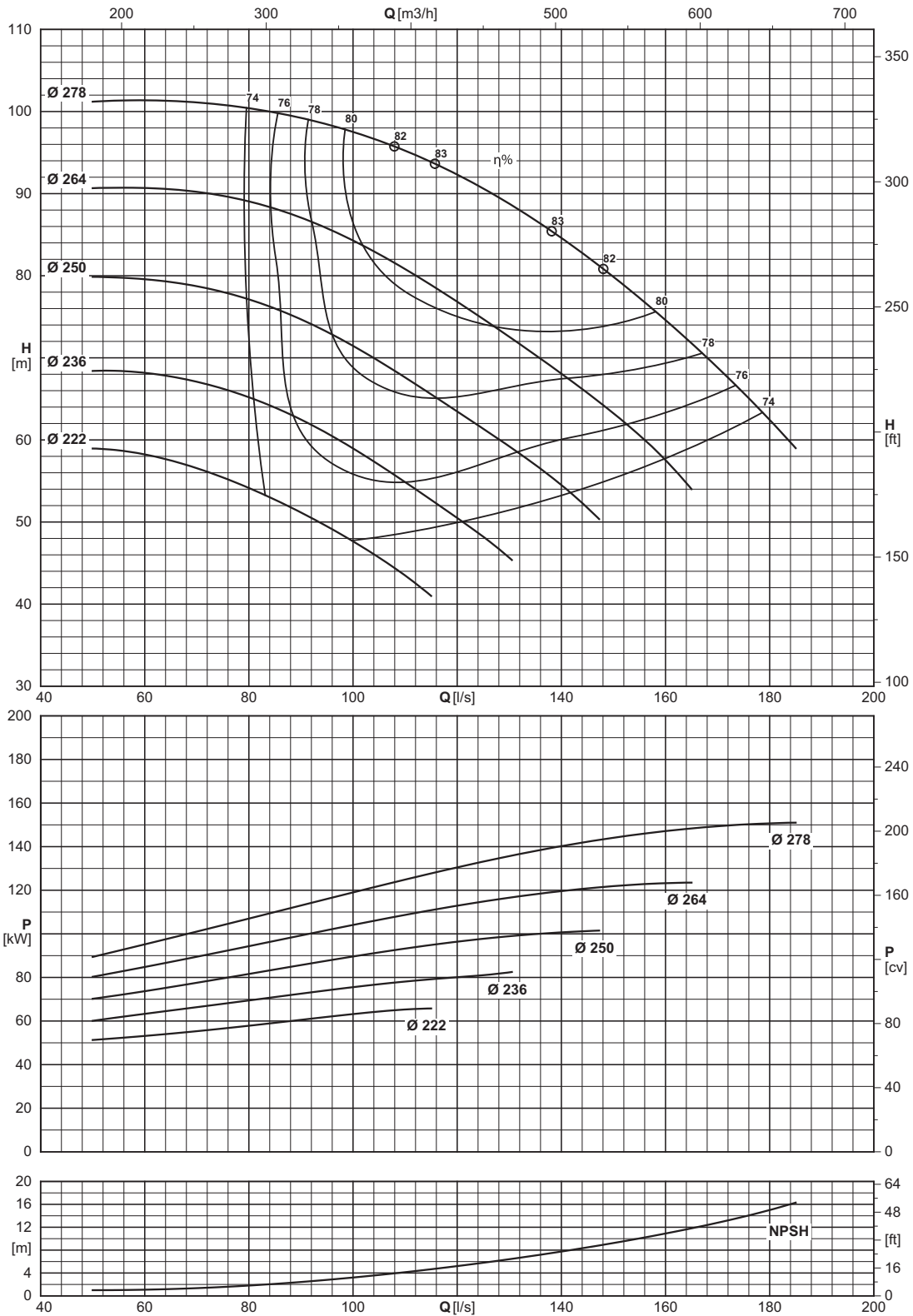

Type Type Tipo	Inlet maximum pressure (*) Pression maximale en aspiration (*) Pressione massima in aspirazione (*)	Dynamic momentum J Momentum dynamique J Momento dinamico J	
		With cast iron impellers Avec roues en fonte Con giranti in ghisa	With AISI 316 impellers Avec roues en AISI 316 Con giranti in AISI 316
		J=1/4PD²	
	[bar]	[kgm²]	[kgm²]
NCH125-250	5	0,0986553	(F) 0,1127489

(\*) Value referred to the impeller with maximum diameter.

(\*) Valeur se référant à la roue à ailettes avec le diamètre maximum. (\*) Valore riferito alla girante con diametro massimo.

Overall dimensions and weights  
 Dimensions d'encombrement et poids  
 Dimensioni di ingombro e pesi

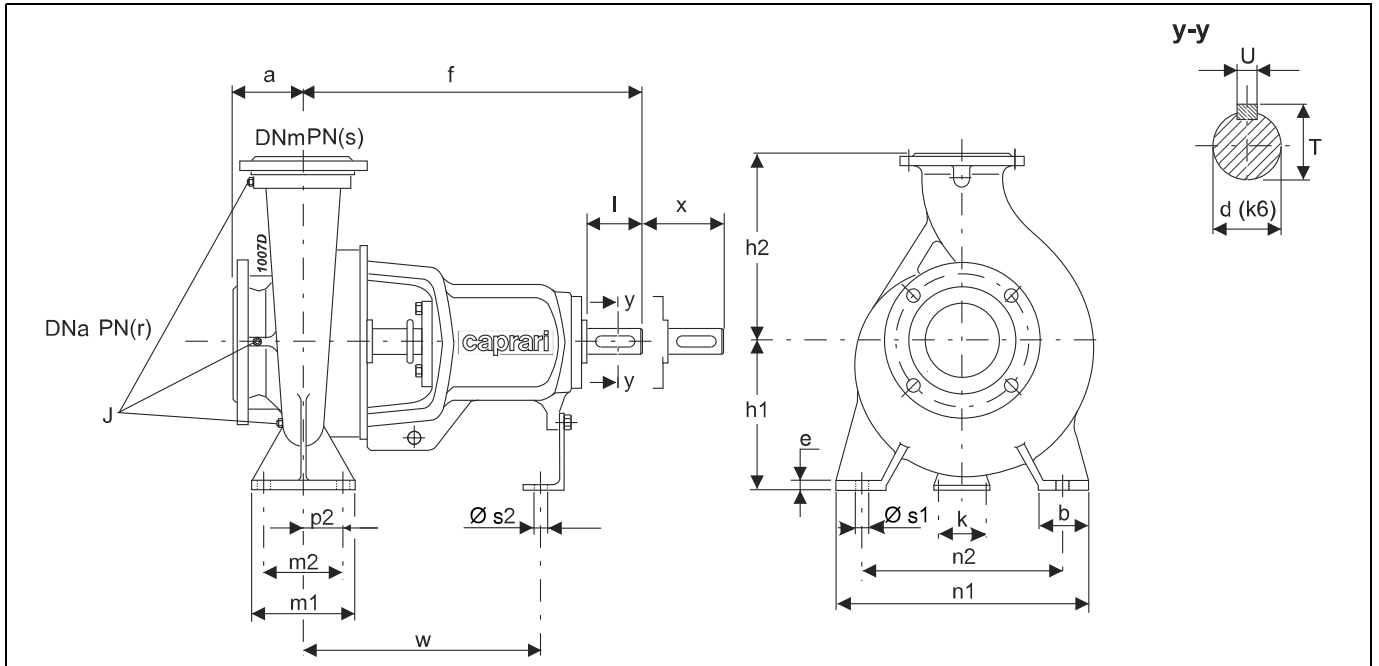

Type Type Tipo	Dimensions pump Dimensions pompe Dimensioni pompa						Duck foot pedestal dimensions Dimensions pieds de soutien Dimensioni piedi di appoggio										Shaft projection Saillie d'arbre Sporgenza d'albero					Plugs Bouchons Tappi	Weight Poids Peso			
	DNa	DNm	r	s	a	f	h1	h2	b	e	m1	m2	p2	n1	n2	k	w	s1	s2	d	l	T	U	X	J	[kg]
	[mm]																									
NC32-125	50	32	16	16	80	360	112	140	50	14	100	70	-	190	140	100	260	$\varnothing 14$	$\varnothing 14$	24	50	27	8	100	G1/4x2.G3/8.G1/4	28
NC32-160	50	32	16	16	80	360	132	160	50	14	100	70	-	240	190	100	260	$\varnothing 14$	$\varnothing 14$	24	50	27	8	100	G1/4x2.G3/8.G1/4	35
NC32-200	50	32	16	16	80	360	160	180	50	14	100	70	-	240	190	110	260	$\varnothing 14$	$\varnothing 14$	24	50	27	8	100	G1/4.G3/8x2.G1/4	41
NC32-250	50	32	16	16	100	360	180	225	65	14	125	95	-	320	250	110	260	$\varnothing 14$	$\varnothing 14$	24	50	27	8	100	G1/4.G3/8x2.G1/4	59
NC40-125	65	40	16	16	80	360	112	140	50	14	100	70	-	210	160	100	260	$\varnothing 14$	$\varnothing 14$	24	50	27	8	100	G1/4x2.G3/8.G1/4	30
NC40-160	65	40	16	16	80	360	132	160	50	14	100	70	-	240	190	100	260	$\varnothing 14$	$\varnothing 14$	24	50	27	8	100	G1/4x2.G3/8.G1/4	36
NC40-200	65	40	16	16	100	360	160	180	50	14	100	70	-	265	212	110	260	$\varnothing 14$	$\varnothing 14$	24	50	27	8	100	G1/4.G3/8x2.G1/4	44
NC40-250	65	40	16	16	100	360	180	225	65	14	125	95	-	320	250	110	260	$\varnothing 14$	$\varnothing 14$	24	50	27	8	100	G1/4.G3/8x2.G1/4	61
NC40-315	65	40	16	16	125	470	200	225	65	14	125	95	-	345	280	110	340	$\varnothing 14$	$\varnothing 14$	32	80	35	10	100	G1/4.G3/8x2.G1/4	96
NC50-125	65	50	16	16	100	360	132	160	50	14	100	70	-	240	190	100	260	$\varnothing 14$	$\varnothing 14$	24	50	27	8	100	G1/4x2.G3/8.G1/4	34
NC50-160	65	50	16	16	100	360	160	180	50	14	100	70	-	265	212	110	260	$\varnothing 14$	$\varnothing 14$	24	50	27	8	100	G1/4.G3/8x2.G1/4	38
NC50-200	65	50	16	16	100	360	160	200	50	14	100	70	-	265	212	110	260	$\varnothing 14$	$\varnothing 14$	24	50	27	8	100	G1/4.G3/8x2.G1/4	46
NC50-250	65	50	16	16	100	360	180	225	65	14	125	95	-	320	250	110	260	$\varnothing 14$	$\varnothing 14$	24	50	27	8	100	G1/4.G3/8x2.G1/4	71
NC50-315	65	50	16	16	125	470	225	280	65	16	125	95	-	345	280	110	340	$\varnothing 14$	$\varnothing 14$	32	80	35	10	100	G1/4.G3/8x2.G1/4	101
NCH50-315	80	50	16	25	125	500	225	280	65	18	125	95	-	345	280	110	370	$\varnothing 14$	$\varnothing 14$	32	80	35	10	100	G1/4x3	87
NC65-125	80	65	16	16	100	360	160	180	65	14	125	95	-	280	212	110	260	$\varnothing 14$	$\varnothing 14$	24	50	27	8	100	G1/4x2.G3/8.G1/4	39
NC65-160	80	65	16	16	100	360	160	200	65	14	125	95	-	280	212	110	260	$\varnothing 14$	$\varnothing 14$	24	50	27	8	100	G1/4.G3/8x2.G1/4	43
NC65-200	80	65	16	16	100	360	180	225	65	14	125	95	-	320	250	110	260	$\varnothing 14$	$\varnothing 14$	24	50	27	8	100	G1/4.G3/8x2.G1/4	52
NC65-250	80	65	16	16	100	470	200	250	80	16	160	120	-	360	280	110	340	$\varnothing 18$	$\varnothing 14$	32	80	35	10	100	G1/4.G3/8x2.G1/4	81
NC65-315	80	65	16	16	125	470	225	280	80	16	160	120	-	400	315	110	340	$\varnothing 18$	$\varnothing 14$	32	80	35	10	100	G1/4.G3/8x2.G1/4	110
NCH65-315	100	65	16	16	125	530	225	280	80	18	160	120	-	400	315	110	370	$\varnothing 18$	$\varnothing 14$	42	110	45	12	140	G1/4x3	118
NC80-160	100	80	16	16	125	360	180	225	65	14	125	95	-	320	250	110	260	$\varnothing 14$	$\varnothing 14$	24	50	27	8	100	G1/4.G3/8x2.G1/4	54
NC80-200	100	80	16	16	125	470	180	250	65	14	125	95	-	345	280	110	340	$\varnothing 14$	$\varnothing 14$	32	80	35	10	100	G1/4.G3/8x2.G1/4	75
NC80-250	100	80	16	16	125	470	200	280	80	16	160	120	-	400	315	110	340	$\varnothing 18$	$\varnothing 14$	32	80	35	10	100	G1/4.G3/8x2.G1/4	91
NC80-315	100	80	16	16	125	470	250	315	80	16	160	120	-	400	315	110	340	$\varnothing 18$	$\varnothing 14$	32	80	35	10	100	G3/8x3. G3/8	120
NC80-400	100	80	16	16	125	532	280	355	85	16	160	120	-	440	340	110	370	$\varnothing 18$	$\varnothing 14$	42	110	45	12	140	G3/8x2 G1/2. G1/4	161
NC100-160	125	100	16	16	125	470	200	250	80	16	160	120	-	360	280	110	340	$\varnothing 18$	$\varnothing 14$	32	80	35	10	140	G3/8x3. G1/4	71

Overall dimensions and weights  
 Dimensions d'encombrement et poids  
 Dimensioni di ingombro e pesi

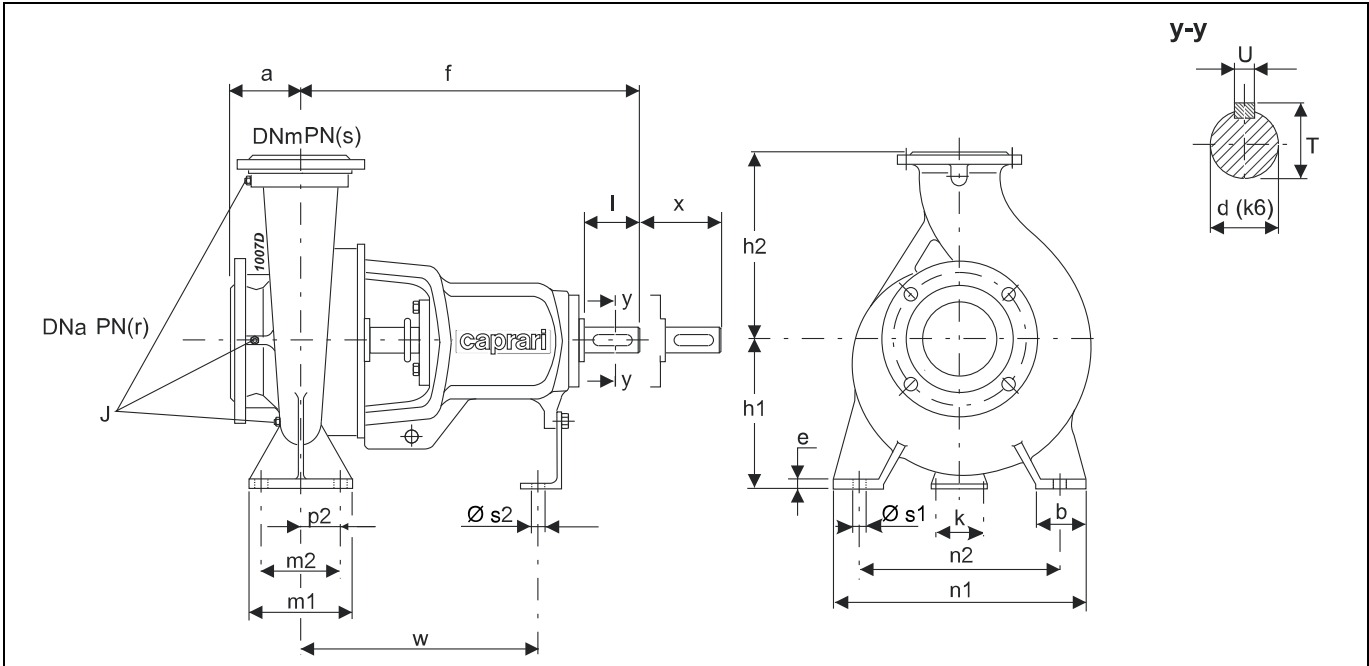

Type Type Tipo	Dimensions pump Dimensions pompe Dimensioni pompa							Duck foot pedestal dimensions Dimensiones pieds de soutien Dimensioni piedi di appoggio										Shaft projection Saillie d'arbre Sporgenza d'albero					Plugs Bouchons Tappi	Weight Poids Peso		
	DNa	DNm	r	s	a	f	h1	h2	b	e	m1	m2	p2	n1	n2	k	w	s1	s2	d	l	T	U		X	J
[mm]																										
NC100-200	125	100	16	16	125	470	200	280	80	16	160	120	-	360	280	110	340	Ø 18	Ø 14	32	80	35	10	140	G3/8×3. G1/4	85
NC100-250	125	100	16	16	140	470	225	280	80	16	160	120	-	400	315	110	340	Ø 18	Ø 14	32	80	35	10	140	G3/8×3. G3/8	106
NC100-315	125	100	16	16	140	470	250	315	80	16	160	120	-	400	315	110	340	Ø 18	Ø 14	32	80	35	10	140	G3/8×3. G3/8	134
NC100-400	125	100	16	16	140	530	280	355	100	18	200	150	-	500	400	110	370	Ø 23	Ø 14	42	110	45	12	140	G3/8×2 G1/2. G1/4	174
NCH100-315	125	100	16	16	140	530	250	315	80	19	160	120	-	400	315	110	370	Ø 18	Ø 14	42	110	45	12	140	G1/4×3	135
NC125-200	150	125	16	16	140	470	250	315	80	16	160	120	-	400	315	110	340	Ø 18	Ø 14	32	80	35	10	140	G3/8×3. G3/8	106
NC125-250	150	125	16	16	140	470	250	355	80	16	160	120	-	400	315	110	340	Ø 18	Ø 14	32	80	35	10	140	G3/8×3. G3/8	125
NC125-315	150	125	16	16	140	530	280	355	100	18	200	150	-	500	400	110	370	Ø 23	Ø 14	42	110	45	12	140	G3/8×2 G1/2. G1/4	163
NC125-400	150	125	16	16	140	530	315	400	100	18	200	150	-	500	400	110	370	Ø 23	Ø 14	42	110	45	12	140	G3/8×2 G1/2. G1/4	191
NCH125-250	150	125	16	16	140	530	250	355	80	19	160	120	-	400	315	110	370	Ø 18	Ø 14	42	110	45	12	140	G1/4×3	140
NCH125-400	150	125	16	16	140	530	315	400	100	21	200	150	-	500	400	110	370	Ø 18	Ø 14	42	110	45	12	140	G1/4×3	186
NCH125-500	150	125	16	16	160	670	355	450	100	25	200	150	-	550	450	140	500	Ø 23	Ø 18	48	110	51,5	14	180	G1/4×3	359
NC150-200	200	150	16	16	160	495	280	400	100	20	200	150	-	550	450	110	370	Ø 23	Ø 14	32	80	35	10	180	G3/8×3. G1/4	181
NC150-250	200	150	16	16	160	530	250	355	100	18	200	150	-	450	350	110	370	Ø 23	Ø 14	42	110	45	12	140	G1/4. G3/8×2 G1/2. G3/8	148
NC150-315	200	150	16	16	160	530	280	400	100	18	200	150	-	550	450	110	370	Ø 23	Ø 14	42	110	45	12	140	G1/4×3	170
NC150-400	200	150	16	16	160	530	315	450	100	18	200	150	-	550	450	110	370	Ø 23	Ø 14	42	110	45	12	140	G3/8×2 G1/2. G1/4	209
NCH150-500	200	150	16	16	160	670	400	500	100	25	200	150	60	550	450	140	480	Ø 23	Ø 18	60	140	64	18	180	G3/8×3	410
NC200-250	250	200	16	16	180	553	315	450	100	20	200	150	-	550	450	110	393	Ø 28	Ø 14	42	110	45	12	180	G3/8×2 G1/2. G3/8	220
NC200-315	250	200	16	16	180	670	315	480	120	20	220	170	-	600	480	110	504	Ø 28	Ø 14	48	110	51	14	180	G3/8×3. G3/8	251
NC200-400	250	200	16	16	180	670	335	480	120	20	220	170	-	600	480	110	504	Ø 28	Ø 14	48	110	51	14	180	G3/8×3. G3/8	295
NCH200-500	250	200	16	16	225	885	400	580	150	28	315	250	-	760	630	180	670	Ø 28	Ø 18	65	140	69	18	250	G3/8×3	577
NC250-315	300	250	16	16	220	691	355	520	150	22	250	200	-	660	510	110	525	Ø 28	Ø 14	48	110	51	14	180	G3/8×3. G3/8	311
NC250-400	300	250	16	16	220	682	400	560	150	22	250	200	-	660	510	110	516	Ø 28	Ø 14	48	110	51	14	180	G3/8×3. G3/8	390
NCH250-250	300	250	16	16	225	885	355	560	125	24	250	190	-	630	500	180	670	Ø 23	Ø 18	65	140	69	18	250	G3/8×3	434
NCH250-500	300	250	16	16	225	885	450	630	150	28	315	250	-	760	630	180	670	Ø 28	Ø 18	65	140	69	18	250	G3/8×3	670
NCHF250-500	300	250	16	16	225	885	450	630	150	28	315	250	-	760	630	180	670	Ø 28	Ø 18	65	140	69	18	250	G3/8×3	670

Selection - dimensions and weights for base mounted electric pumps  
 Sélection - dimensions et poids des électropompes sur socle  
 Selezione - dimensioni e pesi elettropompe su base

COUPLINGS WITH STANDARDIZED ENCLOSED ELECTRIC MOTORS  
 ACCOUPLEMENTS AVEC MOTEURS ÉLECTRIQUES FERMÉS NORMALISÉS  
 ACCOPIAMENTI CON MOTORI ELETTRICI CHIUSI NORMALIZZATI

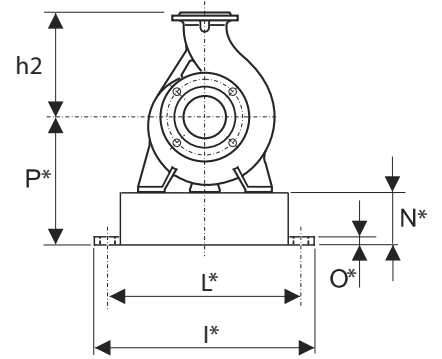
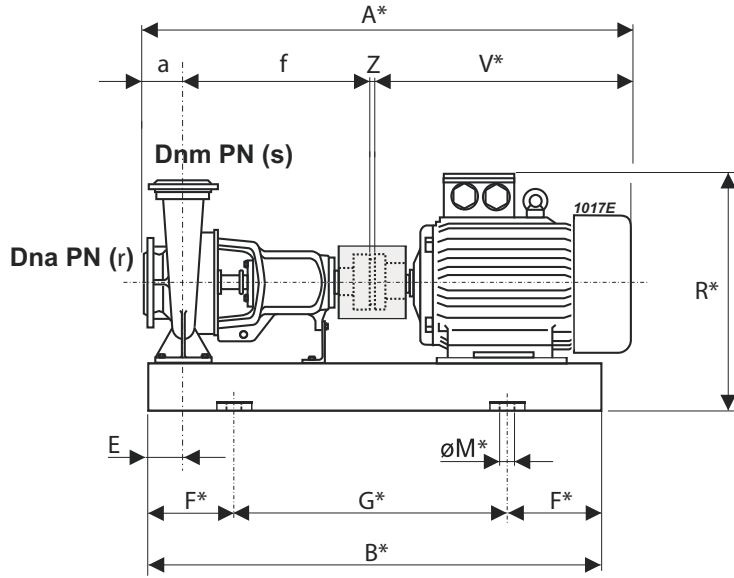

Pump Pompe Pompa		Motor Moteur Motore		BGAN	A*	B*	E	F*	G*	I*	L*	M*	N*	O*	P*	R*	V*	Z	a	f	h2	r	s	Weight Poids Peso	
Type Type Tipo	DNa [mm]	DNm [mm]	[kW]	Size Taille Grand.	Type Type Tipo	[mm]																			[kg]
NC32-125	50	32	1,1	80M	1001/CA	739	649	60	100	449	320	270	ø 16	50	38	162	287	295	4	80	360	140	16	16	54
NC32-125	50	32	1,5	90S	1002/CA	799	665	60	100	465	320	270	ø 16	50	38	162	300	355	4	80	360	140	16	16	58
NC32-125	50	32	2,2	90L	1003/CA	829	690	60	100	490	320	270	ø 16	50	38	162	300	385	4	80	360	140	16	16	61
NC32-160	50	32	2,2	90L	1004/CA	829	690	60	100	490	370	320	ø 16	65	38	197	335	385	4	80	360	160	16	16	74
NC32-160	50	32	3	100L	1005/CA	849	724,5	60	100	524,5	370	320	ø 16	65	38	197	347	405	4	80	360	160	16	16	81
NC32-160	50	32	4	112M	1006/CA	884	732	60	100	532	370	320	ø 16	65	38	197	369	440	4	80	360	160	16	16	88
NC32-160	50	32	5,5	132S	1007/CA	899	773	60	150	473	405	355	ø 16	65	38	197	389	455	4	80	360	160	16	16	98
NC32-160	50	32	7,5	132S	1007/CA	899	773	60	150	473	405	355	ø 16	65	38	197	389	455	4	80	360	160	16	16	103
NC32-200	50	32	5,5	132S	1008/CA	899	773	60	150	473	405	355	ø 16	80	38	240	432	455	4	80	360	180	16	16	108
NC32-200	50	32	7,5	132S	1008/CA	899	773	60	150	473	405	355	ø 16	80	38	240	432	455	4	80	360	180	16	16	113
NC32-200	50	32	11	160M	1009/DA	1071	897	60	150	597	465	415	ø 16	80	38	240	491	627	4	80	360	180	16	16	195
NC32-250	50	32	11	160M	1014/DA	1091	909,5	72,5	150	609,5	450	400	ø 20	100	42	280	531	627	4	100	360	225	16	16	239
NC32-250	50	32	15	160M	1014/DA	1091	909,5	72,5	150	609,5	450	400	ø 20	100	42	280	531	627	4	100	360	225	16	16	250
NC32-250	50	32	18,5	160L	1015/DA	1091	953,5	72,5	150	653,5	450	400	ø 20	100	42	280	531	627	4	100	360	225	16	16	252
NC40-125	65	40	1,5	90S	1010/CA	799	665	60	100	465	340	290	ø 16	50	38	162	300	355	4	80	360	140	16	16	60
NC40-125	65	40	2,2	90L	1011/CA	829	690	60	100	490	340	290	ø 16	50	38	162	300	385	4	80	360	140	16	16	64
NC40-125	65	40	3	100L	1150/CA	849	724,5	60	100	524,5	340	290	ø 16	50	38	162	312	405	4	80	360	140	16	16	71
NC40-160	65	40	3	100L	1005/CA	849	724,5	60	100	524,5	370	320	ø 16	65	38	197	347	405	4	80	360	160	16	16	82
NC40-160	65	40	4	112M	1006/CA	884	732	60	100	532	370	320	ø 16	65	38	197	369	440	4	80	360	160	16	16	89
NC40-160	65	40	5,5	132S	1007/CA	899	773	60	150	473	405	355	ø 16	65	38	197	389	455	4	80	360	160	16	16	99
NC40-160	65	40	7,5	132S	1007/CA	899	773	60	150	473	405	355	ø 16	65	38	197	389	455	4	80	360	160	16	16	104
NC40-200	65	40	5,5	132S	1012/CA	919	773	60	150	473	395	345	ø 16	80	38	240	432	455	4	100	360	180	16	16	120
NC40-200	65	40	7,5	132S	1012/CA	919	773	60	150	473	395	345	ø 16	80	38	240	432	455	4	100	360	180	16	16	125
NC40-200	65	40	11	160M	1013/DA	1091	897	60	150	597	465	415	ø 16	80	38	240	491	627	4	100	360	180	16	16	209
NC40-200	65	40	15	160M	1013/DA	1091	897	60	150	597	465	415	ø 16	80	38	240	491	627	4	100	360	180	16	16	220
NC40-250	65	40	11	160M	1014/DA	1091	909,5	72,5	150	609,5	450	400	ø 20	100	42	280	531	627	4	100	360	225	16	16	241
NC40-250	65	40	15	160M	1014/DA	1091	909,5	72,5	150	609,5	450	400	ø 20	100	42	280	531	627	4	100	360	225	16	16	252
NC40-250	65	40	18,5	160L	1015/DA	1091	953,5	72,5	150	653,5	450	400	ø 20	100	42	280	531	627	4	100	360	225	16	16	254
NC40-250	65	40	22	180M	1016/EA	1129	963,5	72,5	150	663,5	500	450	ø 20	100	42	280	550	665	4	100	360	225	16	16	305
NC40-250	65	40	30	200L	1017/FA	1202	1061,5	97,5	200	661,5	540	490	ø 20	100	42	300	600	738	4	100	360	225	16	16	356
NC40-250	65	40	37	200L	1017/FA	1202	1061,5	97,5	200	661,5	540	490	ø 20	100	42	300	600	738	4	100	360	225	16	16	384
NC50-125	65	50	2,2	90L	1004/CA	849	690	60	100	490	370	320	ø 16	65	38	197	335	385	4	100	360	160	16	16	73
NC50-125	65	50	3	100L	1005/CA	869	724,5	60	100	524,5	370	320	ø 16	65	38	197	347	405	4	100	360	160	16	16	80
NC50-125	65	50	4	112M	1121/CA	904	732	60	100	532	370	320	ø 16	65	38	197	369	440	4	100	360	160	16	16	82
NC50-125	65	50	5,5	132S	1122/CA	919	773	60	150	473	405	355	ø 16	65	38	197	389	455	4	100	360	160	16	16	95

BGAN = Base and coupling

\* = Indicatives values according to the type of motor installed.

BGAN = Socle et accouplement

\* = Valeurs indicatives en fonction de la marque du moteur utilisé.

BGAN = Base e giunto

\* = Valori indicativi in funzione della marca di motore utilizzato.

Selection - dimensions and weights for base mounted electric pumps  
Sélection - dimensions et poids des électropompes sur socle  
Selezione - dimensioni e pesi elettropompe su base

COUPLINGS WITH STANDARDIZED ENCLOSED ELECTRIC MOTORS  
ACCOUPEMENTS AVEC MOTEURS ÉLECTRIQUES FERMÉS NORMALISÉS  
ACCOPIAMENTI CON MOTORI ELETTRICI CHIUSI NORMALIZZATI

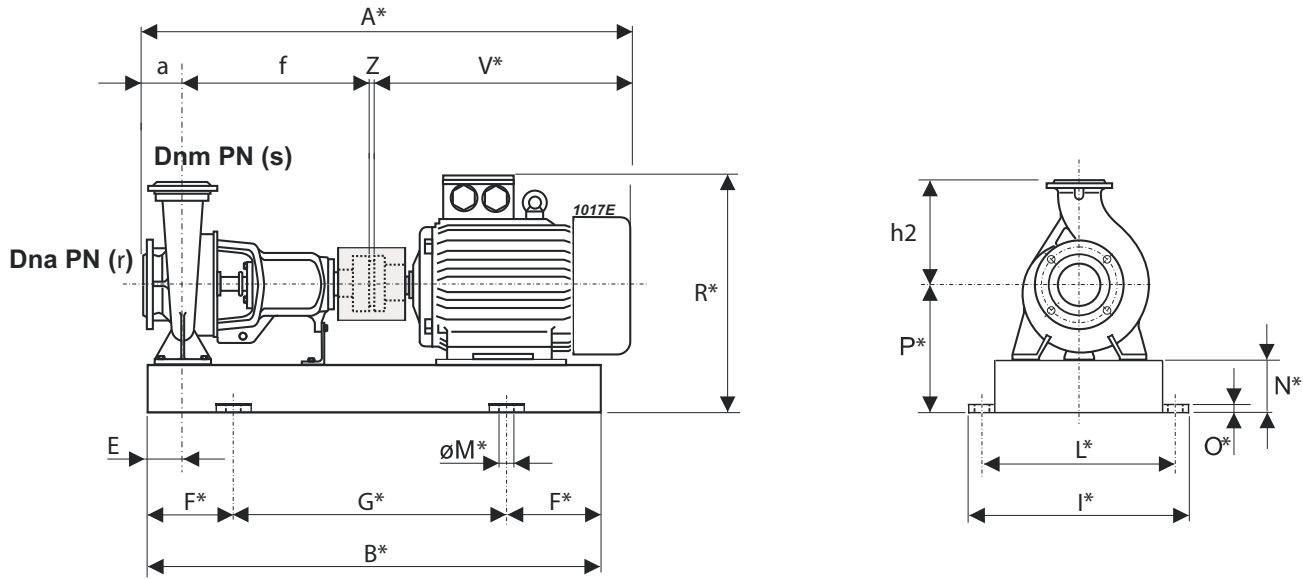

Pump Pompe Pompa		Motor Moteur Motore		BGAN	A*	B*	E	F*	G*	I*	L*	M*	N*	O*	P*	R*	V*	Z	a	f	h2	r	s	Weight Poids Peso	
Type Type Tipo	DNa [mm]	DNm [mm]	[kW]	Size Taille Grand.	Type Type Tipo	[mm]																		[kg]	
NC50-160	65	50	4	112M	1018/CA	904	742	60	100	542	395	345	ø 16	80	38	240	412	440	4	100	360	180	16	16	97
NC50-160	65	50	5,5	132S	1012/CA	919	773	60	150	473	395	345	ø 16	80	38	240	432	455	4	100	360	180	16	16	114
NC50-160	65	50	7,5	132S	1012/CA	919	773	60	150	473	395	345	ø 16	80	38	240	432	455	4	100	360	180	16	16	119
NC50-160	65	50	11	160M	1013/DA	1091	897	60	150	597	465	415	ø 16	80	38	240	491	627	4	100	360	180	16	16	203
NC50-160	65	50	15	160M	1013/DA	1091	897	60	150	597	465	415	ø 16	80	38	240	491	627	4	100	360	180	16	16	214
NC50-200	65	50	11	160M	1013/DA	1091	897	60	150	597	465	415	ø 16	80	38	240	491	627	4	100	360	200	16	16	211
NC50-200	65	50	15	160M	1013/DA	1091	897	60	150	597	465	415	ø 16	80	38	240	491	627	4	100	360	200	16	16	222
NC50-200	65	50	18,5	160L	1155/CA	1091	941	60	150	641	465	415	ø 16	80	38	240	491	627	4	100	360	200	16	16	214
NC50-250	65	50	18,5	160L	1015/DA	1091	953,5	72,5	150	653,5	450	400	ø 20	100	42	280	531	627	4	100	360	225	16	16	264
NC50-250	65	50	22	180M	1016/EA	1129	963,5	72,5	150	663,5	500	450	ø 20	100	42	280	550	665	4	100	360	225	16	16	315
NC50-250	65	50	30	200L	1017/FA	1202	1061,5	97,5	200	661,5	540	490	ø 20	100	42	300	600	738	4	100	360	225	16	16	366
NC50-250	65	50	37	200L	1017/FA	1202	1061,5	97,5	200	661,5	540	490	ø 20	100	42	300	600	738	4	100	360	225	16	16	394
NCH50-315	80	50	22	180M	2000/EX	1294	1103,5	72,5	200	703,5	500	450	ø 20	120	42	345	615	665	4	125	500	280	16	25	338
NCH50-315	80	50	30	200L	2001/FX	1367	1176,5	72,5	200	776,5	540	490	ø 20	120	42	345	645	738	4	125	500	280	16	25	397
NCH50-315	80	50	37	200L	2001/FX	1367	1176,5	72,5	200	776,5	540	490	ø 20	120	42	345	645	738	4	125	500	280	16	25	425
NCH50-315	80	50	45	225M	2002/FX	1404	1202,5	72,5	200	802,5	585	535	ø 20	120	42	345	675	775	4	125	500	280	16	25	485
NCH50-315	80	50	55	250M	2003/GX	1499	1319,5	97,5	200	919,5	635	585	ø 20	120	42	370	745	870	4	125	500	280	16	25	659
NCH50-315	80	50	75	280S	2004/HX	1629	1379	100	250	879	695	645	ø 20	140	42	420	815	1000	4	125	500	280	16	25	738
NCH50-315	80	50	90	280M	2005/HX	1680	1430	100	250	930	695	645	ø 20	140	42	420	815	1051	4	125	500	280	16	25	790
NC65-125	80	65	5,5	132S	1019/CA	919	785,5	72,5	150	485,5	410	360	ø 16	80	38	240	432	455	4	100	360	180	16	16	100
NC65-125	80	65	7,5	132S	1019/CA	919	785,5	72,5	150	485,5	410	360	ø 16	80	38	240	432	455	4	100	360	180	16	16	105
NC65-125	80	65	11	160M	1020/DA	1091	909,5	72,5	150	609,5	465	415	ø 16	80	38	240	491	627	4	100	360	180	16	16	187
NC65-160	80	65	7,5	132S	1019/CA	919	785,5	72,5	150	485,5	410	360	ø 16	80	38	240	432	455	4	100	360	200	16	16	109
NC65-160	80	65	11	160M	1020/DA	1091	909,5	72,5	150	609,5	465	415	ø 16	80	38	240	491	627	4	100	360	200	16	16	191
NC65-160	80	65	15	160M	1020/DA	1091	909,5	72,5	150	609,5	465	415	ø 16	80	38	240	491	627	4	100	360	200	16	16	202
NC65-160	80	65	18,5	160L	1123/DA	1091	953,5	72,5	150	653,5	465	415	ø 16	80	38	240	491	627	4	100	360	200	16	16	227
NC65-200	80	65	11	160M	1014/DA	1091	909,5	72,5	150	609,5	450	400	ø 20	100	42	280	531	627	4	100	360	225	16	16	232
NC65-200	80	65	15	160M	1014/DA	1091	909,5	72,5	150	609,5	450	400	ø 20	100	42	280	531	627	4	100	360	225	16	16	243
NC65-200	80	65	18,5	160L	1015/DA	1091	953,5	72,5	150	653,5	450	400	ø 20	100	42	280	531	627	4	100	360	225	16	16	245
NC65-200	80	65	22	180M	1016/EA	1129	963,5	72,5	150	663,5	500	450	ø 20	100	42	280	550	665	4	100	360	225	16	16	296
NC65-200	80	65	30	200L	1017/FA	1202	1061,5	97,5	200	661,5	540	490	ø 20	100	42	300	600	738	4	100	360	225	16	16	347
NC65-200	80	65	37	200L	1017/FA	1202	1061,5	97,5	200	661,5	540	490	ø 20	100	42	300	600	738	4	100	360	225	16	16	375
NC65-250	80	65	30	200L	1021/FX	1312	1164	90	200	764	540	490	ø 20	100	42	300	600	738	4	100	470	250	16	16	392
NC65-250	80	65	37	200L	1021/FX	1312	1164	90	200	764	540	490	ø 20	100	42	300	600	738	4	100	470	250	16	16	420
NC65-250	80	65	45	225M	1022/FX	1349	1220	120	200	820	585	535	ø 20	120	42	345	675	775	4	100	470	250	16	16	510
NC65-250	80	65	55	250M	1032/GX	1444	1312	120	200	912	635	585	ø 20	120	42	370	745	870	4	100	470	250	16	16	555
NC65-250	80	65	75	280S	1125/HX	1574	1369	120	250	869	695	645	ø 20	140	42	420	815	1000	4	100	470	250	16	16	742

BGAN = Base and coupling  
\* = Indicatives values according to the type of motor installed.  
○ Motor in IE4 efficiency class according to EU REGULATION 2019/1781. Available in other efficiency classes for non-EU markets.

BGAN = Socle et accouplement  
\* = Valeurs indicatives en fonction de la marque du moteur utilisé.  
○ Moteur en classe de rendement IE4 conformément au RÈGLEMENT UE2019/1781. Disponibilités en différentes classes de rendement pour les marchés hors UE.

BGAN = Base e giunto  
\* = Valori indicativi in funzione della marca di motore utilizzato.  
○ Motore in classe di efficienza IE4 in conformità al REGOLAMENTO UE2019/1781. Disponibili in altre classi di efficienza per mercati extra UE.

Selection - dimensions and weights for base mounted electric pumps  
*Sélection - dimensions et poids des électropompes sur socle*  
 Selezione - dimensioni e pesi elettropompe su base

COUPLINGS WITH STANDARDIZED ENCLOSED ELECTRIC MOTORS  
*ACCOUPEMENTS AVEC MOTEURS ÉLECTRIQUES FERMÉS NORMALISÉS*  
 ACCOPIAMENTI CON MOTORI ELETTRICI CHIUSI NORMALIZZATI

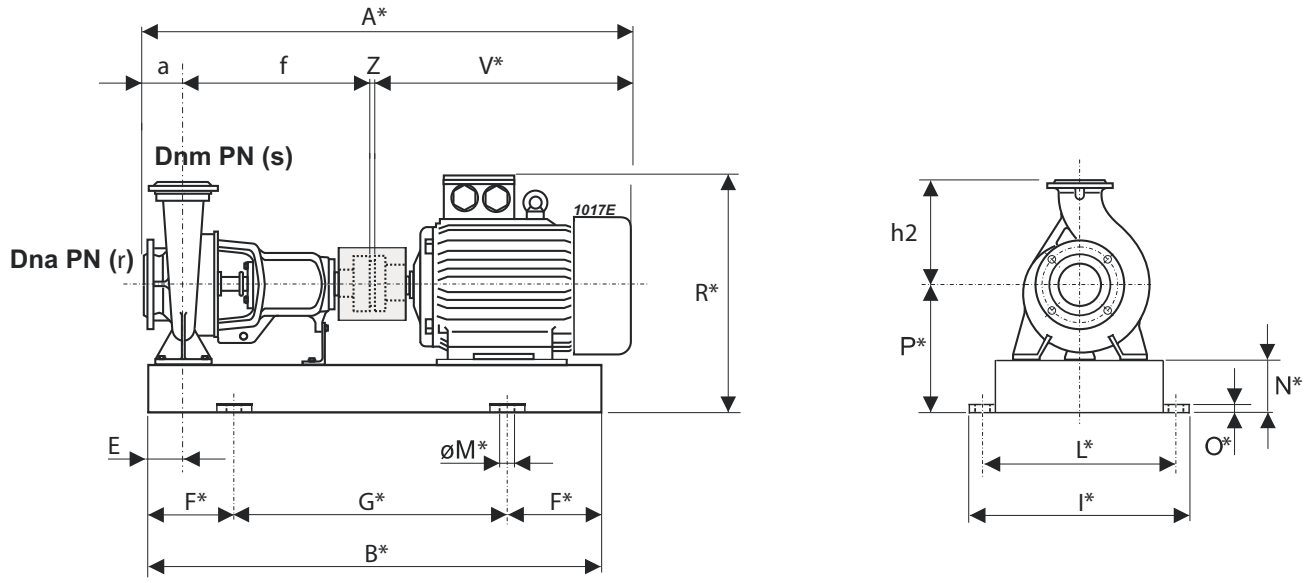

Pump Pompe		Motor Moteur		BGAN	A *	B *	E	F *	G *	I *	L *	M *	N *	O *	P *	R *	V *	Z	a	f	h2	r	s	Weight Poids Peso	
Type Type	DNa [mm]	DNm [mm]	Size Taille Grand.																						Type Type
NCH65-315	100	65	37	200L	2006/FX	1397	1224	90	200	824	530	480	∅ 20	120	42	345	645	738	4	125	530	280	16	16	457
NCH65-315	100	65	45	225M	2007/FX	1434	1250	90	200	850	585	535	∅ 20	120	42	345	675	775	4	125	530	280	16	16	516
NCH65-315	100	65	55	250M	2008/GX	1529	1372	120	250	872	635	585	∅ 20	120	42	370	745	870	4	125	530	280	16	16	615
NCH65-315	100	65	75	280S	2009/HX	1659	1439	130	250	939	695	645	∅ 20	140	42	420	815	1000	4	125	530	280	16	16	772
NCH65-315	100	65	90	280M	2010/HX	1710	1490	130	250	990	695	645	∅ 20	140	42	420	815	1051	4	125	530	280	16	16	824
NCH65-315	100	65	110	315S	2011/HX	1840	1536	130	250	1036	780	730	∅ 22	160	50	475	1030	1181	4	125	530	280	16	16	1229
NCH65-315	100	65	132	315M	2012/HX	1950	1646	130	250	1146	780	730	∅ 22	160	50	475	1030	1291	4	125	530	280	16	16	1358
NCH65-315	100	65	160	315L	2012/IX	1950	1646	130	250	1146	780	730	∅ 22	160	50	475	1030	1291	4	125	530	280	16	16	1499
NC80-160	100	80	11	160M	1014/DA	1116	909,5	72,5	150	609,5	450	400	∅ 20	100	42	280	531	627	4	125	360	225	16	16	234
NC80-160	100	80	15	160M	1014/DA	1116	909,5	72,5	150	609,5	450	400	∅ 20	100	42	280	531	627	4	125	360	225	16	16	245
NC80-160	100	80	18,5	160L	1015/DA	1116	953,5	72,5	150	653,5	450	400	∅ 20	100	42	280	531	627	4	125	360	225	16	16	247
NC80-160	100	80	22	180M	1016/EA	1154	963,5	72,5	150	663,5	500	450	∅ 20	100	42	280	550	665	4	125	360	225	16	16	298
NC80-160	100	80	30	200L	1017/FA	1227	1061,5	97,5	200	661,5	540	490	∅ 20	100	42	300	600	738	4	125	360	225	16	16	349
NC80-200	100	80	15	160M	1023/DX	1226	1019,5	72,5	150	719,5	475	425	∅ 20	100	42	280	531	627	4	125	470	250	16	16	257
NC80-200	100	80	18,5	160L	1024/DX	1226	1063,5	72,5	200	663,5	475	425	∅ 20	100	42	280	531	627	4	125	470	250	16	16	270
NC80-200	100	80	22	180M	1025/EX	1264	1073,5	72,5	200	673,5	500	450	∅ 20	100	42	280	550	665	4	125	470	250	16	16	324
NC80-200	100	80	30	200L	1026/FX	1337	1171,5	97,5	200	771,5	540	490	∅ 20	100	42	300	600	738	4	125	470	250	16	16	362
NC80-200	100	80	37	200L	1026/FX	1337	1171,5	97,5	200	771,5	540	490	∅ 20	100	42	300	600	738	4	125	470	250	16	16	390
NC80-200	100	80	45	225M	1124/FX	1374	1197,5	97,5	200	797,5	585	535	∅ 20	120	42	345	675	775	4	125	470	250	16	16	482
NC80-250	100	80	37	200L	1027/FX	1337	1164	90	200	764	530	480	∅ 20	100	42	300	600	738	4	125	470	280	16	16	416
NC80-250	100	80	45	225M	1028/FX	1374	1220	120	200	820	585	535	∅ 20	120	42	345	675	775	4	125	470	280	16	16	469
NC80-250	100	80	55	250M	1029/GX	1469	1312	120	200	912	635	585	∅ 20	120	42	370	745	870	4	125	470	280	16	16	565
NC80-250	100	80	75	280S	1030/HX	1599	1369	120	250	869	695	645	∅ 20	140	42	420	815	1000	4	125	470	280	16	16	674
NC100-160	125	100	22	180M	1031/EX	1264	1091	90	200	691	490	440	∅ 20	100	42	300	570	665	4	125	470	250	16	16	311
NC100-160	125	100	30	200L	1021/FX	1337	1164	90	200	764	540	490	∅ 20	100	42	300	600	738	4	125	470	250	16	16	382
NC100-160	125	100	37	200L	1021/FX	1337	1164	90	200	764	540	490	∅ 20	100	42	300	600	738	4	125	470	250	16	16	410
NC100-200	125	100	22	180M	1031/EX	1264	1091	90	200	691	490	440	∅ 20	100	42	300	570	665	4	125	470	280	16	16	325
NC100-200	125	100	30	200L	1021/FX	1337	1164	90	200	764	540	490	∅ 20	100	42	300	600	738	4	125	470	280	16	16	396
NC100-200	125	100	37	200L	1021/FX	1337	1164	90	200	764	540	490	∅ 20	100	42	300	600	738	4	125	470	280	16	16	355
NC100-200	125	100	45	225M	1022/FX	1374	1220	120	200	820	585	535	∅ 20	120	42	345	675	775	4	125	470	280	16	16	413
NC100-200	125	100	55	250M	1032/GX	1469	1312	120	200	912	635	585	∅ 20	120	42	370	745	870	4	125	470	280	16	16	559
NC100-200	125	100	75	280S	1125/HX	1599	1369	120	250	869	695	645	∅ 20	140	42	420	815	1000	4	125	470	280	16	16	746
NC100-250	125	100	45	225M	1033/FX	1389	1190	90	200	790	585	535	∅ 20	120	42	345	675	775	4	140	470	280	16	16	504
NC100-250	125	100	55	250M	1034/GX	1484	1312	120	200	912	635	585	∅ 20	120	42	370	745	870	4	140	470	280	16	16	601
NC100-250	125	100	75	280S	1035/HE	1614	1379	130	250	879	695	645	∅ 20	140	42	420	815	1000	4	140	470	280	16	16	737
NC100-250	125	100	90	280M	1036/HE	1665	1430	130	250	930	695	645	∅ 20	140	42	420	815	1051	4	140	470	280	16	16	770
NC100-250	125	100	110	315S	1126/IX	1795	1476	130	250	976	780	730	∅ 22	160	50	475	1030	1181	4	140	470	280	16	16	1191

BGAN = Base and coupling  
 \* = Indicatives values according to the type of motor installed.  
 ○ Motor in IE4 efficiency class according to EU REGULATION 2019/1781. Available in other efficiency classes for non-EU markets.

BGAN = Socle et accouplement  
 \* = Valeurs indicatives en fonction de la marque du moteur utilisé.  
 ○ Moteur en classe de rendement IE4 conformément au REGLEMENT UE2019/1781. Disponibili in différentes classes de rendement pour les marchés hors UE.

BGAN = Base e giunto  
 \* = Valori indicativi in funzione della marca di motore utilizzato.  
 ○ Motore in classe di efficienza IE4 in conformità al REGOLAMENTO UE2019/1781. Disponibili in altre classi di efficienza per mercati extra UE.

Selection - dimensions and weights for base mounted electric pumps  
Sélection - dimensions et poids des électropompes sur socle  
Selezione - dimensioni e pesi elettropompe su base

COUPLINGS WITH STANDARDIZED ENCLOSED ELECTRIC MOTORS  
ACCOUPLLEMENTS AVEC MOTEURS ÉLECTRIQUES FERMÉS NORMALISÉS  
ACCOPIAMENTI CON MOTORI ELETTRICI CHIUSI NORMALIZZATI

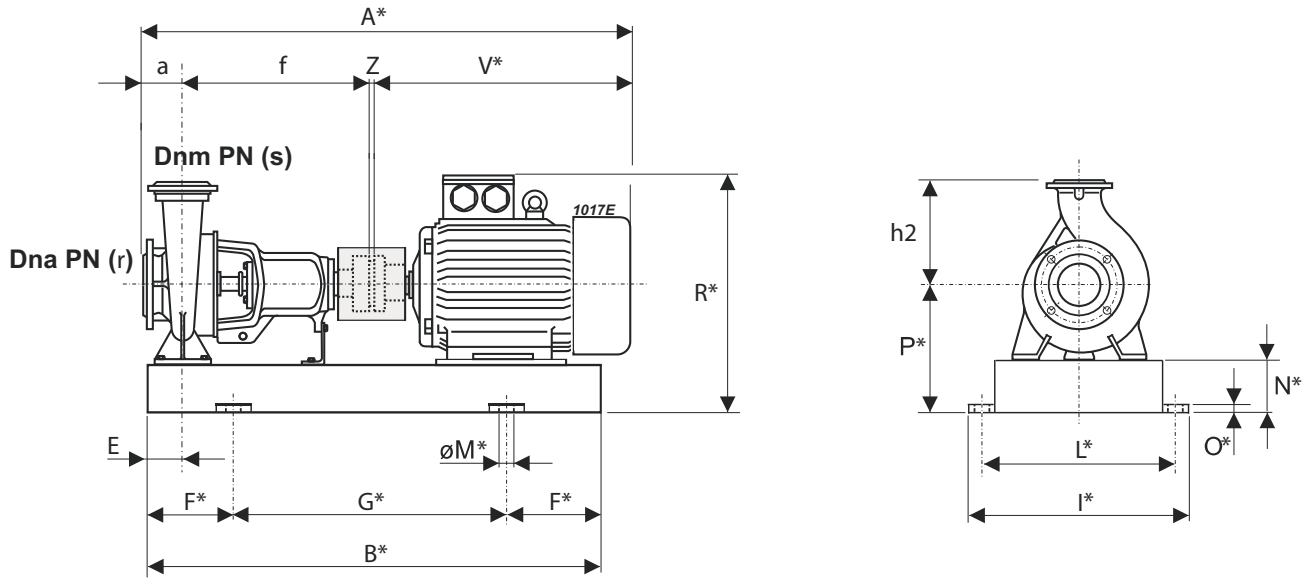

Pump Pompe Pompa		Motor Moteur Motore		BGAN	A*	B*	E	F*	G*	I*	L*	M*	N*	O*	P*	R*	V*	Z	a	f	h2	r	s	Weight Poids Peso	
Type Type Tipo	DNa [mm]	DNm [mm]	[kW]	Size Taille Grand.	Type Type Tipo	[mm]																	[kg]		
NCH100-315	125	100	55	250M	2013/GX	1544	1342	90	200	942	635	585	ø 20	120	42	370	745	870	4	140	530	315	16	16	629
NCH100-315	125	100	75	280S	2014/HX	1674	1419	120	250	919	695	645	ø 20	140	42	420	815	1000	4	140	530	315	16	16	778
NCH100-315	125	100	90	280M	2015/HX	1725	1470	120	250	970	695	645	ø 20	140	42	420	815	1051	4	140	530	315	16	16	831
NCH100-315	125	100	110	315S	2016/HX	1855	1536	130	250	1036	780	730	ø 22	160	50	475	1030	1181	4	140	530	315	16	16	1125
NCH100-315	125	100	132	315M	2017/HX	1965	1646	130	250	1146	780	730	ø 22	160	50	475	1030	1291	4	140	530	315	16	16	1328
NCH100-315	125	100	160	315L	2017/LX	1965	1646	130	250	1146	780	730	ø 22	160	50	475	1030	1291	4	140	530	315	16	16	1405
NCH100-315	125	100	200	315L	2017/IE4/LX	2055	1736	130	300	1136	780	730	ø 22	160	50	475	1030	1381	4	140	530	315	16	16	1485
NC125-200	150	125	55	250M	1094/GX	1484	1282	90	200	882	635	585	ø 20	120	42	370	745	870	4	140	470	315	16	16	598
NC125-200	150	125	75	280S	1095/HE	1614	1359	120	250	859	695	645	ø 20	140	42	420	815	1000	4	140	470	315	16	16	748
NC125-200	150	125	90	280M	1107/HE	1665	1410	120	250	910	695	645	ø 20	140	42	420	815	1051	4	140	470	315	16	16	800
NCH125-250	150	125	55	250M	2013/GX	1544	1342	90	200	942	635	585	ø 20	120	42	370	745	870	4	140	530	355	16	16	634
NCH125-250	150	125	75	280S	2014/HX	1674	1419	120	250	919	695	645	ø 20	140	42	420	815	1000	4	140	530	355	16	16	783
NCH125-250	150	125	90	280M	2015/HX	1725	1470	120	250	970	695	645	ø 20	140	42	420	815	1051	4	140	530	355	16	16	836
NCH125-250	150	125	110	315S	2016/HX	1855	1536	130	250	1036	780	730	ø 22	160	50	475	1030	1181	4	140	530	355	16	16	1130
NCH125-250	150	125	132	315M	2017/HX	1965	1646	130	250	1146	780	730	ø 22	160	50	475	1030	1291	4	140	530	355	16	16	1333
NCH125-250	150	125	160	315L	2017/LX	1965	1646	130	250	1146	780	730	ø 22	160	50	475	1030	1291	4	140	530	355	16	16	1410
NCH125-250	150	125	200	315L	2017/IE4/LX	2055	1736	130	300	1136	780	730	ø 22	160	50	475	1030	1381	4	140	530	355	16	16	1490

BGAN = Base and coupling

\* = Indicatives values according to the type of motor installed.

○ Motor in IE4 efficiency class according to EU REGULATION 2019/1781. Available in other efficiency classes for non-EU markets.

BGAN = Socle et accouplement

\* = Valeurs indicatives en fonction de la marque du moteur utilisé.

○ Moteur en classe de rendement IE4 conformément au RÉGLEMENT UE2019/1781. Disponibilité en différentes classes de rendement pour les marchés hors UE.

BGAN = Base e giunto

\* = Valori indicativi in funzione della marca di motore utilizzato.

○ Motore in classe di efficienza IE4 in conformità al REGOLAMENTO UE2019/1781. Disponibili in altre classi di efficienza per mercati extra UE.



Selection - dimensions and weights for base mounted electric pumps  
 Sélection - dimensions et poids des électropompes sur socle  
 Selezione - dimensioni e pesi elettropompe su base

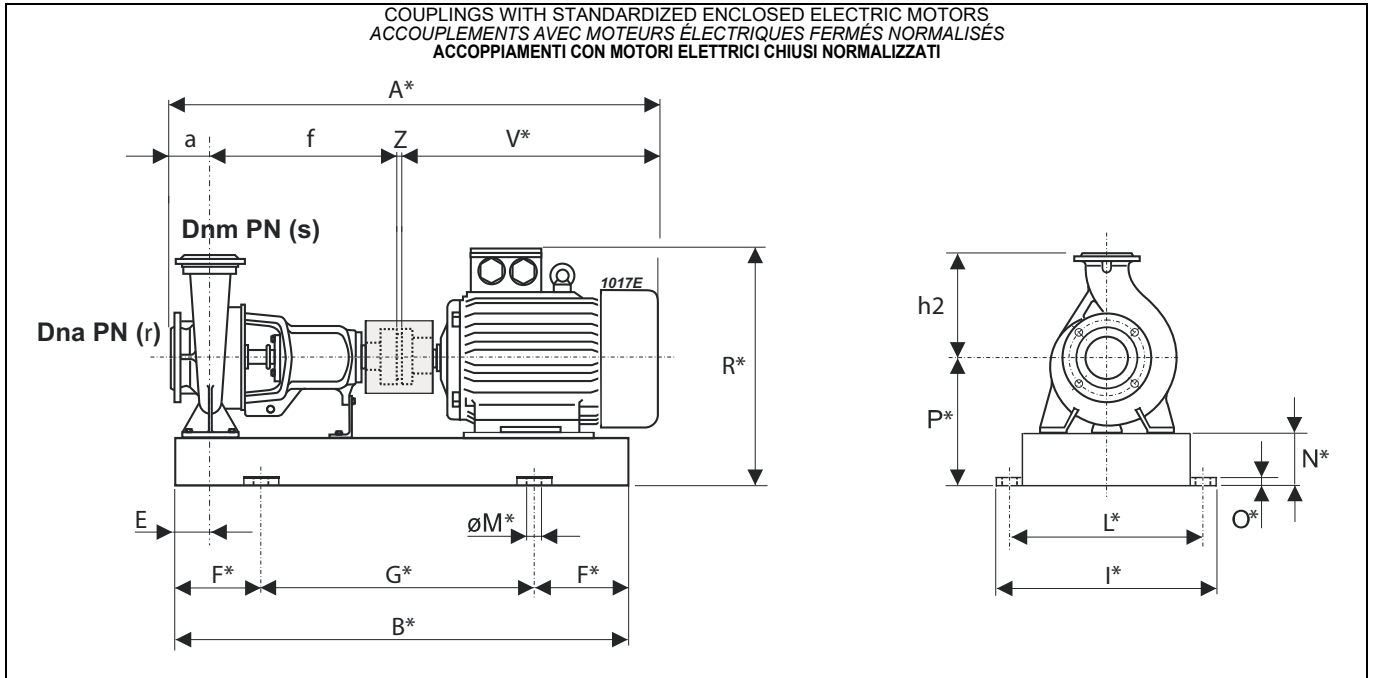

Pump Pompe Pompa			Motor Moteur Motore		BGAN	A*	B*	E	F*	G*	I*	L*	M*	N*	O*	P*	R*	V*	Z	a	f	h2	r	s	Weight Poids Peso	
Type Type Tipo	DNa [mm]	DNm [mm]	[kW]	Size Taille Grand.	Type Type Tipo	[mm]																				[kg]
NC32-125	50	32	1,1	90S	1002/CA	799	665	60	100	465	320	270	∅ 16	50	38	162	300	355	4	80	360	140	16	16	59	
NC32-125	50	32	1,5	90L	1003/CA	829	690	60	100	490	320	270	∅ 16	50	38	162	300	385	4	80	360	140	16	16	63	
NC32-160	50	32	0,75	80M	1040/CA	739	659	60	100	459	370	320	∅ 16	65	38	197	322	295	4	80	360	160	16	16	24307	
NC32-160	50	32	1,1	90S	1041/CA	799	665	60	100	465	370	320	∅ 16	65	38	197	335	355	4	80	360	160	16	16	71	
NC32-200	50	32	0,75	80M	1042/CA	739	649	60	100	449	370	320	∅ 16	80	38	240	365	295	4	80	360	180	16	16	83	
NC32-200	50	32	1,1	90S	1043/CA	799	665	60	100	465	370	320	∅ 16	80	38	240	378	355	4	80	360	180	16	16	85	
NC32-200	50	32	1,5	90L	1044/CA	829	690	60	100	490	370	320	∅ 16	80	38	240	378	385	4	80	360	180	16	16	88	
NC32-250	50	32	2,2	100L	1050/CA	869	737	72,5	100	537	450	400	∅ 20	100	42	280	430	405	4	100	360	225	16	16	131	
NC32-250	50	32	3	100L	1050/CA	869	737	72,5	100	537	450	400	∅ 20	100	42	280	430	405	4	100	360	225	16	16	135	
NC32-250	50	32	4	112M	1051/CA	904	744,5	72,5	100	544,5	450	400	∅ 20	100	42	280	452	440	4	100	360	225	16	16	131	
NC40-125	65	40	1,1	90S	1010/CA	799	665	60	100	465	340	290	∅ 16	50	38	162	300	355	4	80	360	140	16	16	61	
NC40-160	65	40	0,75	80M	1040/CA	739	659	60	100	459	370	320	∅ 16	65	38	197	322	295	4	80	360	160	16	16	24308	
NC40-160	65	40	1,1	90S	1041/CA	799	665	60	100	465	370	320	∅ 16	65	38	197	335	355	4	80	360	160	16	16	72	
NC40-200	65	40	0,75	80M	1047/CA	759	649	60	100	449	395	345	∅ 16	80	38	240	365	295	4	100	360	180	16	16	73	
NC40-200	65	40	1,1	90S	1048/CA	819	665	60	100	465	395	345	∅ 16	80	38	240	378	355	4	100	360	180	16	16	89	
NC40-200	65	40	1,5	90L	1049/CA	849	690	60	100	490	395	345	∅ 16	80	38	240	378	385	4	100	360	180	16	16	94	
NC40-250	65	40	2,2	100L	1050/CA	869	737	72,5	100	537	450	400	∅ 20	100	42	280	430	405	4	100	360	225	16	16	133	
NC40-250	65	40	3	100L	1050/CA	869	737	72,5	100	537	450	400	∅ 20	100	42	280	430	405	4	100	360	225	16	16	137	
NC40-250	65	40	4	112M	1051/CA	904	744,5	72,5	100	544,5	450	400	∅ 20	100	42	280	452	440	4	100	360	225	16	16	133	
NC40-315	65	40	4	112M	1053/DX	1039	854,5	72,5	150	554,5	475	425	∅ 20	100	42	300	472	440	4	125	470	225	16	16	178	
NC40-315	65	40	5,5	132S	1054/DX	1054	895,5	72,5	150	595,5	475	425	∅ 20	100	42	300	492	455	4	125	470	225	16	16	185	
NC40-315	65	40	7,5	132M	1055/DX	1089	933,5	72,5	150	633,5	475	425	∅ 20	100	42	300	492	490	4	125	470	225	16	16	195	
NC40-315	65	40	11	160M	1056/EX	1226	1019,5	72,5	150	719,5	475	425	∅ 20	100	42	300	551	627	4	125	470	225	16	16	270	
NC50-125	65	50	0,75	80M	1040/CA	759	659	60	100	459	370	320	∅ 16	65	38	197	322	295	4	100	360	160	16	16	24306	
NC50-160	65	50	0,75	80M	1047/CA	759	649	60	100	449	395	345	∅ 16	80	38	240	365	295	4	100	360	180	16	16	73	
NC50-160	65	50	1,1	90S	1048/CA	819	665	60	100	465	395	345	∅ 16	80	38	240	378	355	4	100	360	180	16	16	83	
NC50-160	65	50	1,5	90L	1049/CA	849	690	60	100	490	395	345	∅ 16	80	38	240	378	385	4	100	360	180	16	16	88	
NC50-200	65	50	1,1	90S	1048/CA	819	665	60	100	465	395	345	∅ 16	80	38	240	378	355	4	100	360	200	16	16	91	
NC50-200	65	50	1,5	90L	1049/CA	849	690	60	100	490	395	345	∅ 16	80	38	240	378	385	4	100	360	200	16	16	96	
NC50-200	65	50	2,2	100L	1052/CA	869	724,5	60	100	524,5	395	345	∅ 16	80	38	240	390	405	4	100	360	200	16	16	107	
NC50-250	65	50	2,2	100L	1050/CA	869	737	72,5	100	537	450	400	∅ 20	100	42	280	430	405	4	100	360	225	16	16	143	
NC50-250	65	50	3	100L	1050/CA	869	737	72,5	100	537	450	400	∅ 20	100	42	280	430	405	4	100	360	225	16	16	147	
NC50-250	65	50	4	112M	1051/CA	904	744,5	72,5	100	544,5	450	400	∅ 20	100	42	280	452	440	4	100	360	225	16	16	143	
NC50-315	65	50	4	112M	1132/DX	1039	854,5	72,5	150	554,5	475	425	∅ 20	120	42	345	517	440	4	125	470	280	16	16	195	
NC50-315	65	50	5,5	132S	1133/DX	1054	895,5	72,5	150	595,5	475	425	∅ 20	120	42	345	537	455	4	125	470	280	16	16	201	
NC50-315	65	50	7,5	132M	1134/DX	1089	933,5	72,5	150	633,5	475	425	∅ 20	120	42	345	537	490	4	125	470	280	16	16	211	
NC50-315	65	50	11	160M	1135/EX	1226	1029,5	72,5	150	729,5	475	425	∅ 20	120	42	345	596	627	4	125	470	280	16	16	325	
NC65-125	80	65	0,75	80M	1152/CA	759	661,5	72,5	100	461,5	410	360	∅ 16	80	38	240	365	295	4	100	360	180	16	16	84	
NC65-125	80	65	1,1	90S	1153/CA	819	677,5	72,5	100	477,5	410	360	∅ 16	80	38	240	378	355	4	100	360	180	16	16	85	

BGAN = Base and coupling      BGAN = Socle et accouplement      BGAN = Base e giunto  
 \* = Indicatives values according to the type of motor installed.      \* = Valeurs indicatives en fonction de la marque du moteur utilisé.      \* = Valori indicativi in funzione della marca di motore utilizzato.

Selection - dimensions and weights for base mounted electric pumps  
Sélection - dimensions et poids des électropompes sur socle  
Selezione - dimensioni e pesi elettropompe su base

COUPLINGS WITH STANDARDIZED ENCLOSED ELECTRIC MOTORS  
COUPLLEMENTS AVEC MOTEURS ÉLECTRIQUES FERMÉS NORMALISÉS  
ACCOPIAMENTI CON MOTORI ELETTRICI CHIUSI NORMALIZZATI

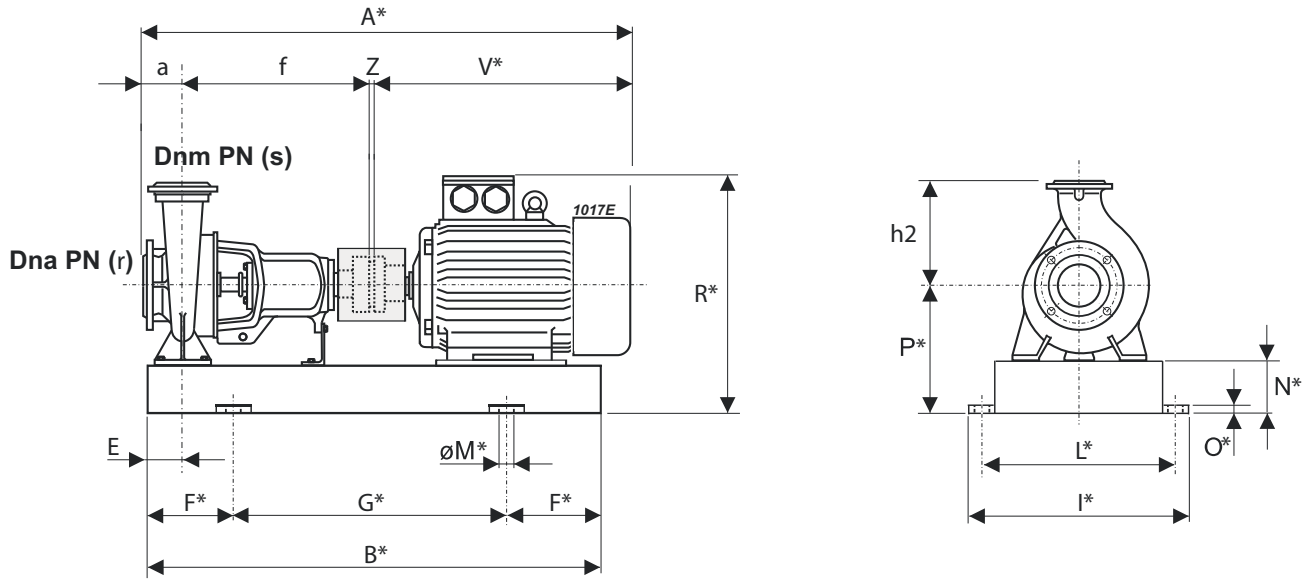

Pump Pompe Pompa		Motor Moteur Motore		BGAN	A*	B*	E	F*	G*	I*	L*	M*	N*	O*	P*	R*	V*	Z	a	f	h2	r	s	Weight Poids Peso	
Type Type Tipo	DNa [mm]	DNm [mm]	[kW]	Size Taille Grand.	Type Type Tipo	[mm]																			[kg]
NC65-160	80	65	0,75	80M	1057/CA	759	661,5	72,5	100	461,5	410	360	ø 16	80	38	240	365	295	4	100	360	200	16	16	88
NC65-160	80	65	1,1	90S	1153/CA	819	677,5	72,5	100	477,5	410	360	ø 16	80	38	240	378	355	4	100	360	200	16	16	89
NC65-160	80	65	1,5	90L	1059/CA	849	702,5	72,5	100	502,5	410	360	ø 16	80	38	240	378	385	4	100	360	200	16	16	94
NC65-160	80	65	2,2	100L	1060/CA	869	737	72,5	100	537	410	360	ø 16	80	38	240	390	405	4	100	360	200	16	16	100
NC65-200	80	65	1,5	90L	1061/CA	849	702,5	72,5	100	502,5	450	400	ø 20	100	42	280	418	385	4	100	360	225	16	16	110
NC65-200	80	65	2,2	100L	1050/CA	869	737	72,5	100	537	450	400	ø 20	100	42	280	430	405	4	100	360	225	16	16	124
NC65-200	80	65	3	100L	1050/CA	869	737	72,5	100	537	450	400	ø 20	100	42	280	430	405	4	100	360	225	16	16	128
NC65-200	80	65	4	112M	1051/CA	904	744,5	72,5	100	544,5	450	400	ø 20	100	42	280	452	440	4	100	360	225	16	16	124
NC65-250	80	65	3	100L	1062/DX	979	864,5	90	150	564,5	490	440	ø 20	100	42	300	450	405	4	100	470	250	16	16	163
NC65-250	80	65	4	112M	1063/DX	1014	872	90	150	572	490	440	ø 20	100	42	300	472	440	4	100	470	250	16	16	164
NC65-250	80	65	5,5	132S	1064/DX	1029	913	90	150	613	490	440	ø 20	100	42	300	492	455	4	100	470	250	16	16	174
NC65-250	80	65	7,5	132M	1065/DX	1064	951	90	150	651	490	440	ø 20	100	42	300	492	490	4	100	470	250	16	16	183
NC65-315	80	65	5,5	132S	1066/DX	1054	913	90	150	613	530	480	ø 20	120	42	345	537	455	4	125	470	280	16	16	215
NC65-315	80	65	7,5	132M	1067/DX	1089	951	90	150	651	530	480	ø 20	120	42	345	537	490	4	125	470	280	16	16	225
NC65-315	80	65	11	160M	1068/EX	1226	1047	90	150	747	530	480	ø 20	120	42	345	596	627	4	125	470	280	16	16	308
NC65-315	80	65	15	160L	1069/EX	1226	1091	90	200	691	530	480	ø 20	120	42	345	596	627	4	125	470	280	16	16	318
NC80-160	100	80	1,1	90S	1070/CA	844	677,5	72,5	100	477,5	450	400	ø 20	100	42	280	418	355	4	125	360	225	16	16	107
NC80-160	100	80	1,5	90L	1061/CA	874	702,5	72,5	100	502,5	450	400	ø 20	100	42	280	418	385	4	125	360	225	16	16	112
NC80-160	100	80	2,2	100L	1050/CA	894	737	72,5	100	537	450	400	ø 20	100	42	280	430	405	4	125	360	225	16	16	126
NC80-160	100	80	3	100L	1050/CA	894	737	72,5	100	537	450	400	ø 20	100	42	280	430	405	4	125	360	225	16	16	130
NC80-200	100	80	2,2	100L	1071/DX	1004	847	72,5	150	547	475	425	ø 20	100	42	280	430	405	4	125	470	250	16	16	150
NC80-200	100	80	3	100L	1071/DX	1004	847	72,5	150	547	475	425	ø 20	100	42	280	430	405	4	125	470	250	16	16	154
NC80-200	100	80	4	112M	1072/DX	1039	854,5	72,5	150	554,5	475	425	ø 20	100	42	280	452	440	4	125	470	250	16	16	156
NC80-200	100	80	5,5	132S	1073/DX	1054	895,5	72,5	150	595,5	475	425	ø 20	100	42	280	472	455	4	125	470	250	16	16	165
NC80-200	100	80	7,5	132M	1074/DX	1089	933,5	72,5	150	633,5	475	425	ø 20	100	42	280	472	490	4	125	470	250	16	16	174
NC80-250	100	80	5,5	132S	1075/DX	1054	913	90	150	613	530	480	ø 20	100	42	300	492	455	4	125	470	280	16	16	185
NC80-250	100	80	7,5	132M	1076/DX	1089	951	90	150	651	530	480	ø 20	100	42	300	492	490	4	125	470	280	16	16	197
NC80-250	100	80	11	160M	1077/EX	1226	1037	90	150	737	530	480	ø 20	100	42	300	551	627	4	125	470	280	16	16	282
NC80-250	100	80	15	160L	1078/EX	1226	1081	90	200	681	530	480	ø 20	100	42	300	551	627	4	125	470	280	16	16	301
NC80-315	100	80	7,5	132M	1079/DX	1089	951	90	150	651	530	480	ø 20	120	42	370	562	490	4	125	470	315	16	16	237
NC80-315	100	80	11	160M	1080/EX	1226	1047	90	150	747	530	480	ø 20	120	42	370	621	627	4	125	470	315	16	16	326
NC80-315	100	80	15	160L	1081/EX	1226	1091	90	200	691	530	480	ø 20	120	42	370	621	627	4	125	470	315	16	16	320
NC80-315	100	80	18,5	180M	1082/FX	1264	1101	90	200	701	530	480	ø 20	120	42	370	640	665	4	125	470	315	16	16	375
NC80-400	100	80	18,5	180M	1091/FY	1326	1163	90	200	763	570	520	ø 20	140	42	420	690	665	4	125	532	355	16	16	479
NC80-400	100	80	22	180L	1092/FY	1366	1201	90	200	801	570	520	ø 20	140	42	420	690	705	4	125	532	355	16	16	500
NC80-400	100	80	30	200L	1093/GY	1419	1236	90	200	836	570	520	ø 20	140	42	420	720	758	4	125	532	355	16	16	510

BGAN = Base and coupling

\* = Indicatives values according to the type of motor installed.

BGAN = Socle et accouplement

\* = Valeurs indicatives en fonction de la marque du moteur utilisé.

BGAN = Base e giunto

\* = Valori indicativi in funzione della marca di motore utilizzato.

Selection - dimensions and weights for base mounted electric pumps  
Sélection - dimensions et poids des électropompes sur socle  
Selezione - dimensioni e pesi elettropompe su base

COUPLINGS WITH STANDARDIZED ENCLOSED ELECTRIC MOTORS  
ACCOUPEMENTS AVEC MOTEURS ÉLECTRIQUES FERMÉS NORMALISÉS  
ACCOPIAMENTI CON MOTORI ELETTRICI CHIUSI NORMALIZZATI

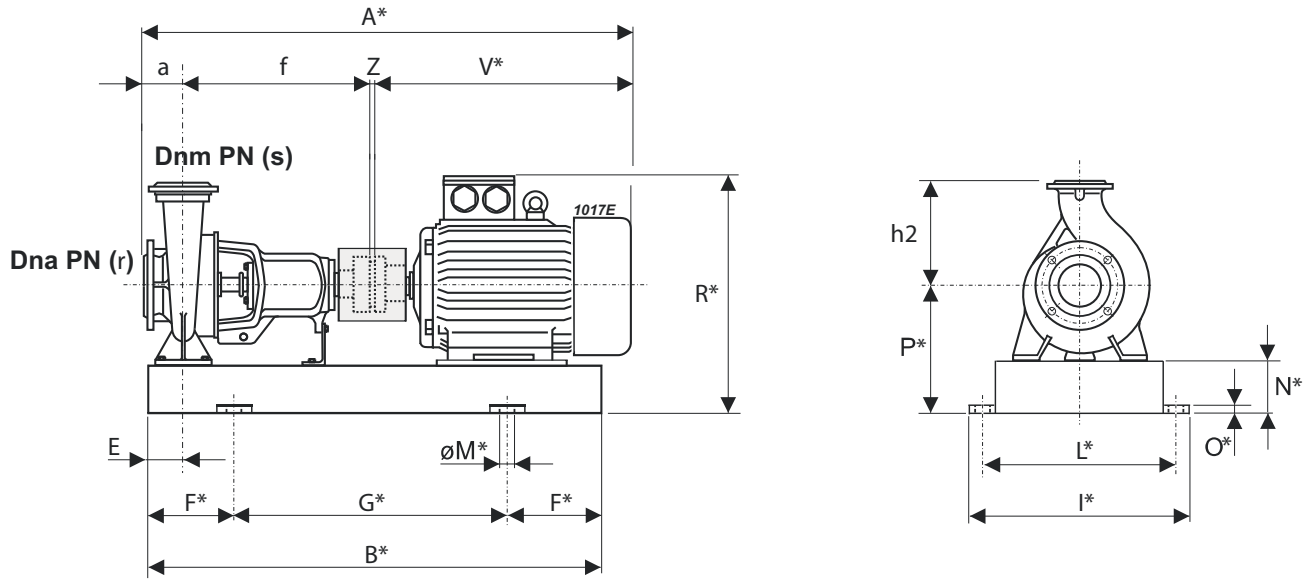

Pump Pompe Pompa			Motor Moteur Motore		BGAN	A	B	E	F	G	I	L	M	N	O	P	R	V	Z	a	f	h2	r	s	Weight Poids Peso
Type Type Tipo	DNa [mm]	DNm [mm]	Size Taille Grand.	Type Type Tipo	[mm]																				[kg]
NC100-160	125	100	3	100L	1062/DX	1004	864,5	90	150	564,5	490	440	ø 20	100	42	300	450	405	4	125	470	250	16	16	153
NC100-160	125	100	4	112M	1063/DX	1039	872	90	150	572	490	440	ø 20	100	42	300	472	440	4	125	470	250	16	16	154
NC100-160	125	100	5,5	132S	1064/DX	1054	913	90	150	613	490	440	ø 20	100	42	300	492	455	4	125	470	250	16	16	164
NC100-160	125	100	7,5	132M	1065/DX	1089	951	90	150	651	490	440	ø 20	100	42	300	492	490	4	125	470	250	16	16	173
NC100-200	125	100	3	100L	1062/DX	1004	864,5	90	150	564,5	490	440	ø 20	100	42	300	450	405	4	125	470	280	16	16	167
NC100-200	125	100	4	112M	1063/DX	1039	872	90	150	572	490	440	ø 20	100	42	300	472	440	4	125	470	280	16	16	168
NC100-200	125	100	5,5	132S	1064/DX	1054	913	90	150	613	490	440	ø 20	100	42	300	492	455	4	125	470	280	16	16	178
NC100-200	125	100	7,5	132M	1065/DX	1089	951	90	150	651	490	440	ø 20	100	42	300	492	490	4	125	470	280	16	16	187
NC100-250	125	100	5,5	132S	1066/DX	1069	913	90	150	613	530	480	ø 20	120	42	345	537	455	4	140	470	280	16	16	211
NC100-250	125	100	7,5	132M	1067/DX	1104	951	90	150	651	530	480	ø 20	120	42	345	537	490	4	140	470	280	16	16	221
NC100-250	125	100	11	160M	1068/EX	1241	1047	90	150	747	530	480	ø 20	120	42	345	596	627	4	140	470	280	16	16	304
NC100-250	125	100	15	160L	1069/EX	1241	1091	90	200	691	530	480	ø 20	120	42	345	596	627	4	140	470	280	16	16	314
NC100-315	125	100	11	160M	1080/EX	1241	1047	90	150	747	530	480	ø 20	120	42	370	621	627	4	140	470	315	16	16	340
NC100-315	125	100	15	160L	1081/EX	1241	1091	90	200	691	530	480	ø 20	120	42	370	621	627	4	140	470	315	16	16	334
NC100-315	125	100	18,5	180M	1082/FX	1279	1101	90	200	701	530	480	ø 20	120	42	370	640	665	4	140	470	315	16	16	389
NC100-315	125	100	22	180L	1083/FX	1319	1139	90	200	739	530	480	ø 20	120	42	370	640	705	4	140	470	315	16	16	420
NC100-400	125	100	22	180L	1084/FY	1379	1219	110	200	819	630	580	ø 20	140	42	420	690	705	4	140	530	355	16	16	450
NC100-400	125	100	30	200L	1085/GY	1432	1254	110	200	854	630	580	ø 20	140	42	420	720	758	4	140	530	355	16	16	534
NC100-400	125	100	37	225S	1086/GY	1467	1275	110	200	875	630	580	ø 20	140	42	420	750	793	4	140	530	355	16	16	618
NC100-400	125	100	45	225M	1087/HY	1492	1300	110	200	900	630	580	ø 20	140	42	420	750	818	4	140	530	355	16	16	660
NC100-400	125	100	55	250M	1088/HY	1554	1362	110	250	862	630	580	ø 20	140	42	420	795	880	4	140	530	355	16	16	748
NC125-200	150	125	7,5	132M	1079/DX	1104	951	90	150	651	530	480	ø 20	120	42	370	562	490	4	140	470	315	16	16	223
NC125-200	150	125	11	160M	1080/EX	1241	1047	90	150	747	530	480	ø 20	120	42	370	621	627	4	140	470	315	16	16	312
NC125-200	150	125	15	160L	1081/EX	1241	1091	90	200	691	530	480	ø 20	120	42	370	621	627	4	140	470	315	16	16	306
NC125-200	150	125	18,5	180M	1082/FX	1279	1101	90	200	701	530	480	ø 20	120	42	370	640	665	4	140	470	315	16	16	361
NC125-200	150	125	22	180L	1083/FX	1319	1139	90	200	739	530	480	ø 20	120	42	370	640	705	4	140	470	315	16	16	392
NC125-250	150	125	11	160M	1080/EX	1241	1047	90	150	747	530	480	ø 20	120	42	370	621	627	4	140	470	355	16	16	331
NC125-250	150	125	15	160L	1081/EX	1241	1091	90	200	691	530	480	ø 20	120	42	370	621	627	4	140	470	355	16	16	325
NC125-250	150	125	18,5	180M	1082/FX	1279	1101	90	200	701	530	480	ø 20	120	42	370	640	665	4	140	470	355	16	16	380
NC125-250	150	125	22	180L	1083/FX	1319	1139	90	200	739	530	480	ø 20	120	42	370	640	705	4	140	470	355	16	16	411
NC125-315	150	125	15	160L	1090/EY	1301	1171	110	200	771	630	580	ø 20	140	42	420	671	627	4	140	530	355	16	16	481
NC125-315	150	125	18,5	180M	1154/FY	1339	1181	110	200	781	630	580	ø 20	140	42	420	690	665	4	140	530	355	16	16	494
NC125-315	150	125	22	180L	1084/FY	1379	1219	110	200	819	630	580	ø 20	140	42	420	690	705	4	140	530	355	16	16	439
NC125-315	150	125	30	200L	1085/GY	1432	1254	110	200	854	630	580	ø 20	140	42	420	720	758	4	140	530	355	16	16	523
NC125-315	150	125	37	225S	1086/GY	1467	1275	110	200	875	630	580	ø 20	140	42	420	750	793	4	140	530	355	16	16	607
NC125-315	150	125	45	225M	1087/HY	1492	1300	110	200	900	630	580	ø 20	140	42	420	750	818	4	140	530	355	16	16	649
NC125-400	150	125	45	225M	1096/HY	1492	1310	110	200	910	630	580	ø 22	160	50	475	805	818	4	140	530	400	16	16	676
NC125-400	150	125	55	250M	1097/HY	1554	1362	110	250	862	630	580	ø 22	160	50	475	850	880	4	140	530	400	16	16	831
NC125-400	150	125	75	280S	1098/IY	1687	1409	110	250	909	695	645	ø 22	160	50	475	870	1013	4	140	530	400	16	16	873

BGAN = Base and coupling  
\* = Indicatives values according to the type of motor installed.

BGAN = Socle et accouplement  
\* = Valeurs indicatives en fonction de la marque du moteur utilisé.

BGAN = Base e giunto  
\* = Valori indicativi in funzione della marca di motore utilizzato.

Motor in IE4 efficiency class according to EU REGULATION 2019/1781. Available in other efficiency classes for non-EU markets.

Moteur en classe de rendement IE4 conformément au RÉGLEMENT UE2019/1781. Disponibilit  en diff rentes classes de rendement pour les march s hors UE.

Motore in classe di efficienza IE4 in conformit  al REGOLAMENTO UE2019/1781. Disponibili in altre classi di efficienza per mercati extra UE.

Selection - dimensions and weights for base mounted electric pumps  
Sélection - dimensions et poids des électropompes sur socle  
Selezione - dimensioni e pesi elettropompe su base

COUPLINGS WITH STANDARDIZED ENCLOSED ELECTRIC MOTORS  
ACCOUPEMENTS AVEC MOTEURS ÉLECTRIQUES FERMÉS NORMALISÉS  
ACCOPIAMENTI CON MOTORI ELETTRICI CHIUSI NORMALIZZATI

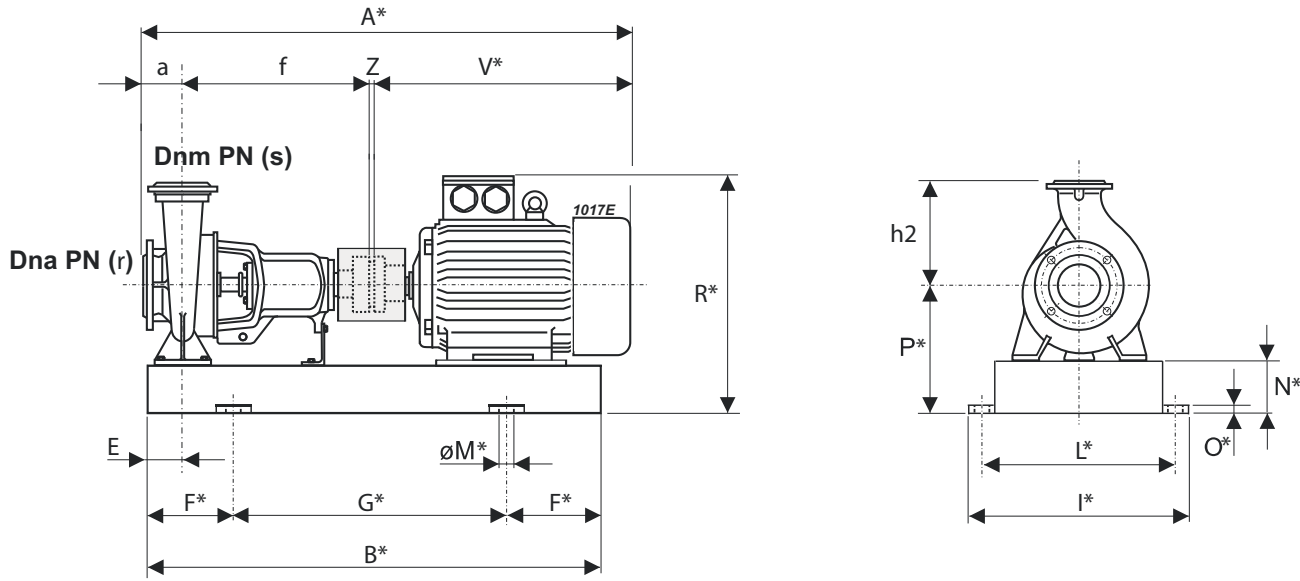

Pump Pompe Pompa		Motor Moteur Motore		BGAN	A*	B*	E	F*	G*	I*	L*	M*	N*	O*	P*	R*	V*	Z	a	f	h2	r	s	Weight Poids Peso	
Type Type Tipo	DNa [mm]	DNm [mm]	[kW]	Size Taille Grand.	Type Type Tipo	[mm]																			[kg]
NCH125-400	150	125	22	180L	2046/FY3	1379	1209	110	200	809	630	580	ø 22	160	50	475	745	705	4	140	530	400	16	16	487
NCH125-400	150	125	30	200L	2048/GY3	1432	1282	110	200	882	630	580	ø 22	160	50	475	775	758	4	140	530	400	16	16	550
NCH125-400	150	125	37	225S	2050/GY3	1467	1285	110	200	885	630	580	ø 22	160	50	475	805	793	4	140	530	400	16	16	638
NCH125-400	150	125	45	225M	2049/HY4	1492	1310	110	200	910	630	580	ø 22	160	50	475	805	818	4	140	530	400	16	16	682
NCH125-400	150	125	55	250M	2051/HY4	1554	1362	110	250	862	630	580	ø 22	160	50	475	850	880	4	140	530	400	16	16	779
NCH125-400	150	125	75	280S	2057/LY4	1687	1409	110	250	909	695	645	ø 22	160	50	475	870	1013	4	140	530	400	16	16	801
NCH125-400	150	125	90	280M	2052/IY4	1738	1460	110	250	960	695	645	ø 22	160	50	475	870	1064	4	140	530	400	16	16	957
NCH125-500	150	125	55	250M	2033/HY4	1714	1512	110	250	1012	680	630	ø 22	180	50	535	910	880	4	160	670	450	16	16	976
NCH125-500	150	125	75	280S	2035/IY4	1847	1559	110	250	1059	680	630	ø 22	180	50	535	930	1013	4	160	670	450	16	16	1019
NCH125-500	150	125	90	280M	2036/IY4	1898	1610	110	250	1110	680	630	ø 22	180	50	535	930	1064	4	160	670	450	16	16	1180
NCH125-500	150	125	110	315S	2025/LY4	2045	1666	110	300	1066	780	730	ø 22	180	50	535	1090	1211	4	160	670	450	16	16	1386
NCH125-500	150	125	132	315M	2037/LY4	2155	1725	110	300	1125	780	730	ø 22	180	50	535	1090	1321	4	160	670	450	16	16	1499
NCH125-500	150	125	160	315L	2037/MY5	2155	1776	110	300	1176	780	730	ø 22	180	50	535	1090	1321	4	160	670	450	16	16	1649
NC150-200	200	150	11	160M	1129/EX	1286	1092	110	200	692	680	630	ø 20	140	42	420	671	627	4	160	495	400	16	16	497
NC150-200	200	150	15	160L	1130/EX	1286	1136	110	200	736	680	630	ø 20	140	42	420	671	627	4	160	495	400	16	16	511
NC150-200	200	150	18,5	180M	1131/FY	1324	1146	110	200	746	680	630	ø 20	140	42	420	690	665	4	160	495	400	16	16	498
NC150-200	200	150	22	180L	1099/FX	1364	1184	110	200	784	680	630	ø 20	140	42	420	690	705	4	160	495	400	16	16	542
NC150-250	200	150	18,5	180M	1136/FY	1359	1181	110	200	781	580	530	ø 20	120	42	370	640	665	4	160	530	355	16	16	425
NC150-250	200	150	22	180L	1137/FY	1399	1219	110	200	819	580	530	ø 20	120	42	370	640	705	4	160	530	355	16	16	446
NC150-250	200	150	30	200L	1151/GY	1452	1244	110	200	844	580	530	ø 20	120	42	370	670	758	4	160	530	355	16	16	502
NC150-315	200	150	22	180L	1138/FY	1399	1219	110	200	819	680	630	ø 20	140	42	420	690	705	4	160	530	400	16	16	532
NC150-315	200	150	30	200L	1100/GX	1452	1254	110	200	854	680	630	ø 20	140	42	420	720	758	4	160	530	400	16	16	491
NC150-315	200	150	37	225S	1101/GX	1487	1275	110	200	875	680	630	ø 20	140	42	420	750	793	4	160	530	400	16	16	623
NC150-315	200	150	45	225M	1102/HY	1512	1300	110	200	900	680	630	ø 20	140	42	420	750	818	4	160	530	400	16	16	636
NC150-315	200	150	55	250M	1103/HY	1574	1362	110	250	862	680	630	ø 20	140	42	420	795	880	4	160	530	400	16	16	817
NC150-400	200	150	45	225M	1139/HY	1512	1310	110	200	910	680	630	ø 22	160	50	475	805	818	4	160	530	450	16	16	729
NC150-400	200	150	55	250M	1140/HY	1574	1362	110	250	862	680	630	ø 22	160	50	475	850	880	4	160	530	450	16	16	808
NC150-400	200	150	75	280S	1104/IY	1707	1409	110	250	909	680	630	ø 22	160	50	475	870	1013	4	160	530	450	16	16	861
NC150-400	200	150	90	280M	1105/IY	1758	1460	110	250	960	680	630	ø 22	160	50	475	870	1064	4	160	530	450	16	16	1113
NC150-400	200	150	110	315S	1106/LY	1905	1536	110	250	1036	780	730	ø 22	160	50	475	1030	1211	4	160	530	450	16	16	1209
NCH150-500	200	150	45	225M	2018/GY2	1652	1521	127	250	1021	680	630	ø 22	200	50	600	930	818	4	160	670	500	16	16	976
NCH150-500	200	150	55	250M	2019/HY2	1714	1578	127	250	1078	680	630	ø 22	200	50	600	975	880	4	160	670	500	16	16	1083
NCH150-500	200	150	75	280S	2020/IY2	1847	1576	127	250	1076	680	630	ø 22	200	50	600	995	1013	4	160	670	500	16	16	1192
NCH150-500	200	150	90	280M	2021/IY2	1898	1627	127	250	1127	680	630	ø 22	200	50	600	995	1064	4	160	670	500	16	16	1248
NCH150-500	200	150	110	315S	2022/LY2	2045	1703	127	300	1103	780	730	ø 22	200	50	600	1155	1211	4	160	670	500	16	16	1473
NCH150-500	200	150	132	315M	2023/MY2	2155	1813	127	300	1213	780	730	ø 22	200	50	600	1155	1321	4	160	670	500	16	16	1530
NCH150-500	200	150	160	315L	2023/MY2	2155	1813	127	300	1213	780	730	ø 22	200	50	600	1155	1321	4	160	670	500	16	16	1680
NCH150-500	200	150	200	315L	2023/IE4/MY2	2245	1916	127	300	1316	780	730	ø 22	200	50	600	1155	1411	4	160	670	500	16	16	1830

BGAN = Base and coupling

\* = Indicatives values according to the type of motor installed.

BGAN = Socle et accouplement

\* = Valeurs indicatives en fonction de la marque du moteur utilisé.

BGAN = Base e giunto

\* = Valori indicativi in funzione della marca di motore utilizzato.

○ Motor in IE4 efficiency class according to EU REGULATION 2019/1781. Available in other efficiency classes for non-EU markets.

○ Moteur en classe de rendement IE4 conformément au RÈGLEMENT UE2019/1781. Disponible en différentes classes de rendement pour les marchés hors UE.

○ Motore in classe di efficienza IE4 in conformità al REGOLAMENTO UE2019/1781. Disponibili in altre classi di efficienza per mercati extra UE.

Selection - dimensions and weights for base mounted electric pumps  
 Sélection - dimensions et poids des électropompes sur socle  
 Selezione - dimensioni e pesi elettropompe su base

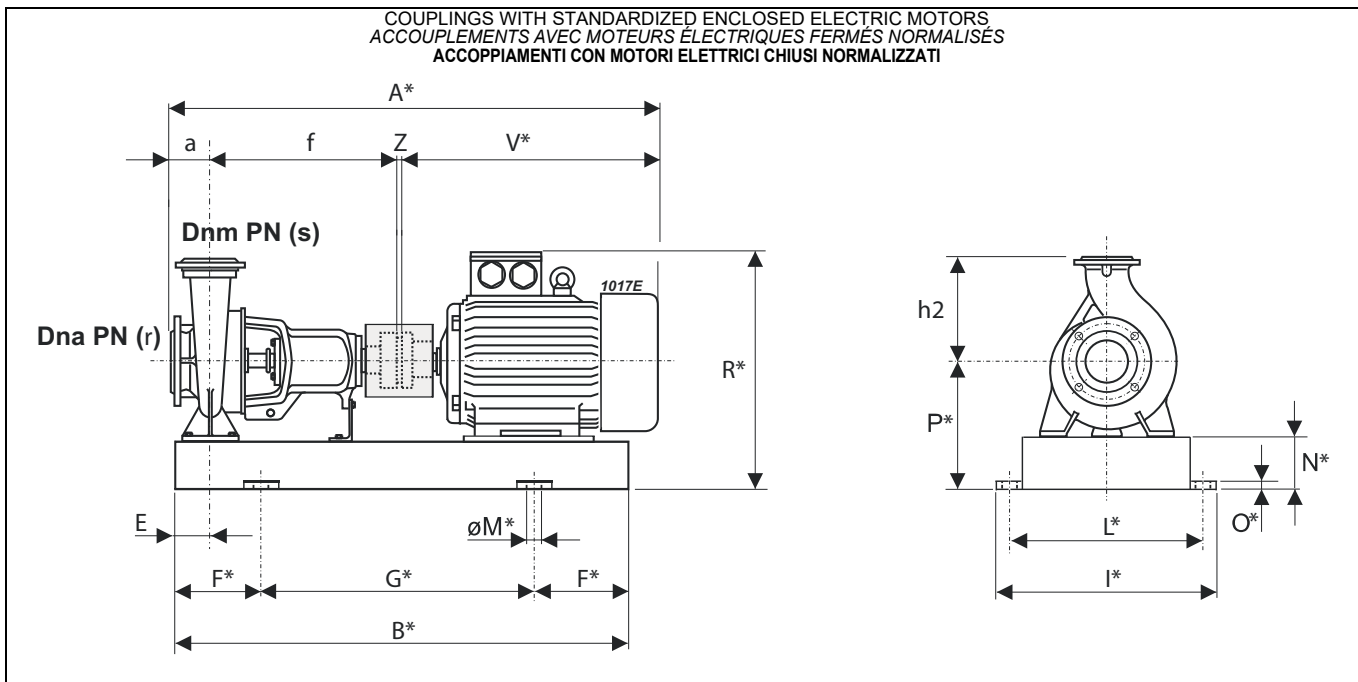

Pump Pompe Pompa			Motor Moteur Motore		BGAN	A	B	E	F	G	I	L	M	N	O	P	R	V	Z	a	f	h2	r	s	Weight Poids Peso
Type Type Tipo	DNa	DNm	Size Taille Grand.	Type Type Tipo	[mm]																			[kg]	
	[mm]	[mm]	[kW]																						
NC200-250	250	200	30	200L	1108/GY	1495	1305	110	200	905	680	630	ø 22	160	50	475	775	758	4	180	553	450	16	16	621
NC200-250	250	200	37	225S	1109/GY	1530	1308	110	200	908	680	630	ø 22	160	50	475	805	793	4	180	553	450	16	16	694
NC200-250	250	200	45	225M	1141/HY	1555	1333	110	200	933	680	630	ø 22	160	50	475	805	818	4	180	553	450	16	16	703
NC200-250	250	200	55	250M	1110/HY	1617	1385	110	250	885	680	630	ø 22	160	50	475	850	880	4	180	553	450	16	16	819
NC200-315	250	200	30	200L	1111/GY2	1612	1432	120	250	932	730	680	ø 22	160	50	475	775	758	4	180	670	480	16	16	664
NC200-315	250	200	37	225S	1112/GY2	1647	1435	120	250	935	730	680	ø 22	160	50	475	805	793	4	180	670	480	16	16	740
NC200-315	250	200	45	225M	1113/HY2	1672	1460	120	250	960	730	680	ø 22	160	50	475	805	818	4	180	670	480	16	16	776
NC200-315	250	200	55	250M	1114/HY2	1734	1512	120	250	1012	730	680	ø 22	160	50	475	850	880	4	180	670	480	16	16	861
NC200-315	250	200	75	280S	1115/IY2	1867	1559	120	250	1059	730	680	ø 22	160	50	475	870	1013	4	180	670	480	16	16	926
NC200-400	250	200	75	280S	1116/IY2	1867	1584	145	250	1084	730	680	ø 22	160	50	495	890	1013	4	180	670	480	16	16	963
NC200-400	250	200	90	280M	1117/IY2	1918	1635	145	250	1135	730	680	ø 22	160	50	495	890	1064	4	180	670	480	16	16	1166
NC200-400	250	200	110	315S	1118/LY2	2065	1711	145	300	1111	780	730	ø 22	160	50	495	1050	1211	4	180	670	480	16	16	1250
NC200-400	250	200	132	315M	1120/LY2	2175	1770	145	300	1170	780	730	ø 22	160	50	495	1050	1321	4	180	670	480	16	16	1395
NCH200-500	250	200	90	280M	2027/IY4	2178	1885	170	300	1285	890	840	ø 22	200	50	600	995	1064	4	225	885	580	16	16	1489
NCH200-500	250	200	110	315S	2028/LY4	2325	1961	170	350	1261	890	840	ø 22	200	50	600	1155	1211	4	225	885	580	16	16	1701
NCH200-500	250	200	132	315M	2029/LY4	2435	2071	170	350	1371	890	840	ø 22	200	50	600	1155	1321	4	225	885	580	16	16	1815
NCH200-500	250	200	160	315L	2029/MY5	2435	2071	170	350	1371	890	840	ø 22	200	50	600	1155	1321	4	225	885	580	16	16	1965
NCH200-500	250	200	200	315L	2029/IE4/MY5	2525	2161	170	350	1461	890	840	ø 22	200	50	600	1155	1411	4	225	885	580	16	16	2030
NCH200-500	250	200	250	355M	2026/NY5	2670	2215	170	350	1515	890	840	ø 22	200	50	600	1201	1556	4	225	885	580	16	16	2442
NCH200-500	250	200	315	355L	2026/PY5	2670	2215	170	350	1515	890	840	ø 22	200	50	600	1201	1556	4	225	885	580	16	16	2632
NC250-315	300	250	30	200L	1142/GY2	1673	1488	135	250	988	790	740	ø 22	180	50	535	835	758	4	220	691	520	16	16	776
NC250-315	300	250	37	225S	1143/GY2	1708	1505	135	250	1005	790	740	ø 22	180	50	535	865	793	4	220	691	520	16	16	809
NC250-315	300	250	45	225M	1144/HY2	1733	1530	135	250	1030	790	740	ø 22	180	50	535	865	818	4	220	691	520	16	16	854
NC250-315	300	250	55	250M	1145/HY2	1795	1558	135	250	1058	790	740	ø 22	180	50	535	910	880	4	220	691	520	16	16	1025
NC250-315	300	250	75	280S	1146/IY2	1928	1605	135	250	1105	790	740	ø 22	180	50	535	930	1013	4	220	691	520	16	16	946
NC250-400	300	250	75	280S	1147/IY2	1919	1596	135	250	1096	790	740	ø 22	200	50	600	995	1013	4	220	682	560	16	16	1207
NC250-400	300	250	90	280M	1148/IY2	1970	1647	135	250	1147	790	740	ø 22	200	50	600	995	1064	4	220	682	560	16	16	1213
NC250-400	300	250	110	315S	1149/LY2	2117	1723	135	300	1123	790	740	ø 22	200	50	600	1155	1211	4	220	682	560	16	16	1499
NC250-400	300	250	132	315M	1119/LY2	2227	1833	135	300	1233	790	740	ø 22	200	50	600	1155	1321	4	220	682	560	16	16	1500
NC250-400	300	250	160	315L	1119/LY2	2227	1833	135	300	1233	790	740	ø 22	200	50	600	1155	1321	4	220	682	560	16	16	1650
NC250-400	300	250	200	315L	1119/IE4/LY2	2317	1923	135	300	1323	790	740	ø 22	200	50	600	1155	1411	4	220	682	560	16	16	1806
NCH250-250	300	250	75	280S	2054/IY4	2127	1799	135	300	1199	760	710	ø 22	180	50	535	930	1013	4	225	885	560	16	16	1136
NCH250-500	300	250	160	315L	2024/MY5	2435	2071	170	350	1371	890	840	ø 22	220	50	670	1225	1321	4	225	885	630	16	16	2075
NCH250-500	300	250	200	315L	2024/IE4/MY5	2525	2161	170	350	1461	890	840	ø 22	220	50	670	1225	1411	4	225	885	630	16	16	2163
NCH250-500	300	250	250	355M	2040/NY5	2670	2165	170	350	1465	890	840	ø 22	220	50	670	1271	1556	4	225	885	630	16	16	2605
NCH250-500	300	250	315	355L	2040/PY5	2670	2235	170	350	1535	890	840	ø 22	220	50	670	1271	1556	4	225	885	630	16	16	2795
NCH250-500	300	250	355	355L	2040/PY5	2670	2235	170	350	1535	890	840	ø 22	220	50	670	1271	1556	4	225	885	630	16	16	2810

BGAN = Base and coupling  
 \* = Indicatives values according to the type of motor installed.  
 ○ Motor in IE4 efficiency class according to EU REGULATION 2019/1781. Available in other efficiency classes for non-EU markets.

BGAN = Socle et accouplement  
 \* = Valeurs indicatives en fonction de la marque du moteur utilisé.  
 ○ Moteur en classe de rendement IE4 conformément au RÈGLEMENT UE2019/1781. Disponibilité en différentes classes de rendement pour les marchés hors UE.

BGAN = Base e giunto  
 \* = Valori indicativi in funzione della marca di motore utilizzato.  
 ○ Motore in classe di efficienza IE4 in conformità al REGOLAMENTO UE2019/1781. Disponibili in altre classi di efficienza per mercati extra UE.

Selection - dimensions and weights for base mounted electric pumps  
Sélection - dimensions et poids des électropompes sur socle  
Selezione - dimensioni e pesi elettropompe su base

COUPLINGS WITH STANDARDIZED ENCLOSED ELECTRIC MOTORS  
ACCOUPLMENTS AVEC MOTEURS ÉLECTRIQUES FERMÉS NORMALISÉS  
ACCOPIAMENTI CON MOTORI ELETTRICI CHIUSI NORMALIZZATI

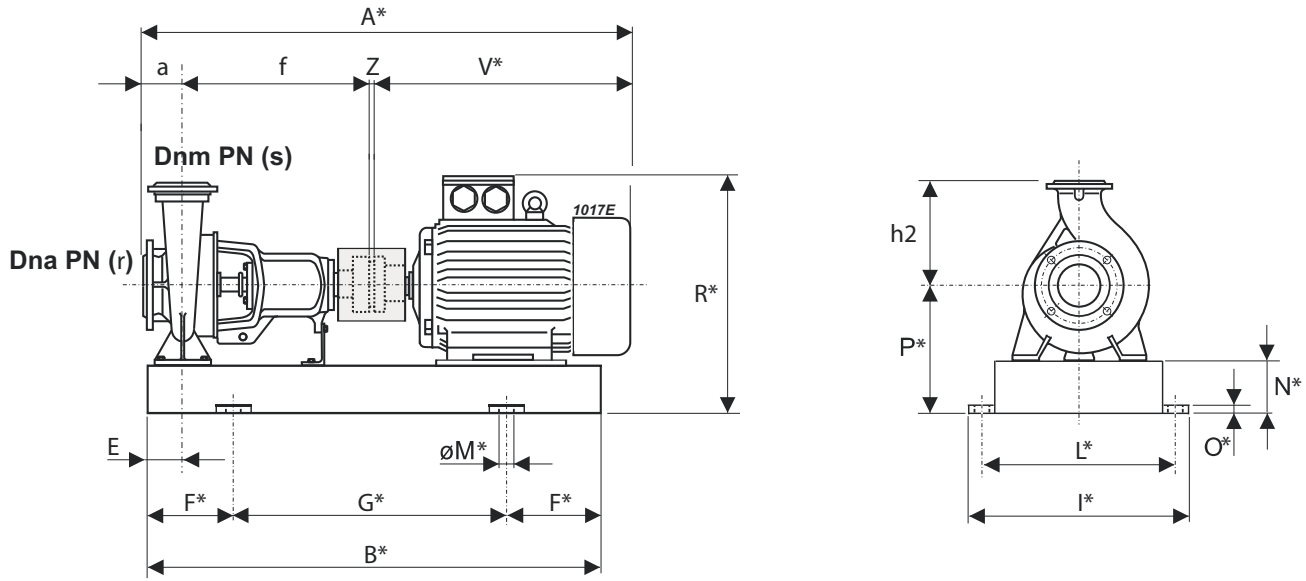

Pump Pompe Pompa		Motor Moteur Motore		BGAN	A*	B*	E	F*	G*	I*	L*	M*	N*	O*	P*	R*	V*	Z	a	f	h2	r	s	Weight Poids Peso	
Type Type Tipo	DNa [mm]	DNm [mm]	[kW]	Size Taille Grand.	Type Type Tipo	[mm]																			[kg]
NCHF250-500	300	250	160 ○	315L	2024/MY5	2435	2071	170	350	1371	890	840	ø 22	220	50	670	1225	1321	4	225	885	630	16	16	2075
NCHF250-500	300	250	200 ○	315L	2024/IE4/MY5	2525	2161	170	350	1461	890	840	ø 22	220	50	670	1225	1411	4	225	885	630	16	16	2163
NCHF250-500	300	250	250	355M	2040/NY5	2670	2165	170	350	1465	890	840	ø 22	220	50	670	1271	1556	4	225	885	630	16	16	2395
NCHF250-500	300	250	315	355L	2040/PY5	2670	2235	170	350	1535	890	840	ø 22	220	50	670	1271	1556	4	225	885	630	16	16	2585
NCHF250-500	300	250	355	355L	2040/PY5	2670	2235	170	350	1535	890	840	ø 22	220	50	670	1271	1556	4	225	885	630	16	16	2600

BGAN = Base and coupling  
\* = Indicatives values according to the type of motor installed.

BGAN = Socle et accouplement  
\* = Valeurs indicatives en fonction de la marque du moteur utilisé.

BGAN = Base e giunto  
\* = Valori indicativi in funzione della marca di motore utilizzato.

○ Motor in IE4 efficiency class according to EU REGULATION 2019/1781. Available in other efficiency classes for non-EU markets.

○ Moteur en classe de rendement IE4 conformément au RÉGLEMENT UE2019/1781. Disponibilité en différentes classes de rendement pour les marchés hors UE.

○ Motore in classe di efficienza IE4 in conformità al REGOLAMENTO UE2019/1781. Disponibili in altre classi di efficienza per mercati extra UE.

Selection - dimensions and weights for base mounted electric pumps  
 Sélection - dimensions et poids des électropompes sur socle  
 Selezione - dimensioni e pesi elettropompe su base

COUPLINGS WITH STANDARDIZED ENCLOSED ELECTRIC MOTORS  
 ACCOUPLEMENTS AVEC MOTEURS ÉLECTRIQUES FERMÉS NORMALISÉS  
 ACCOPIAMENTI CON MOTORI ELETTRICI CHIUSI NORMALIZZATI

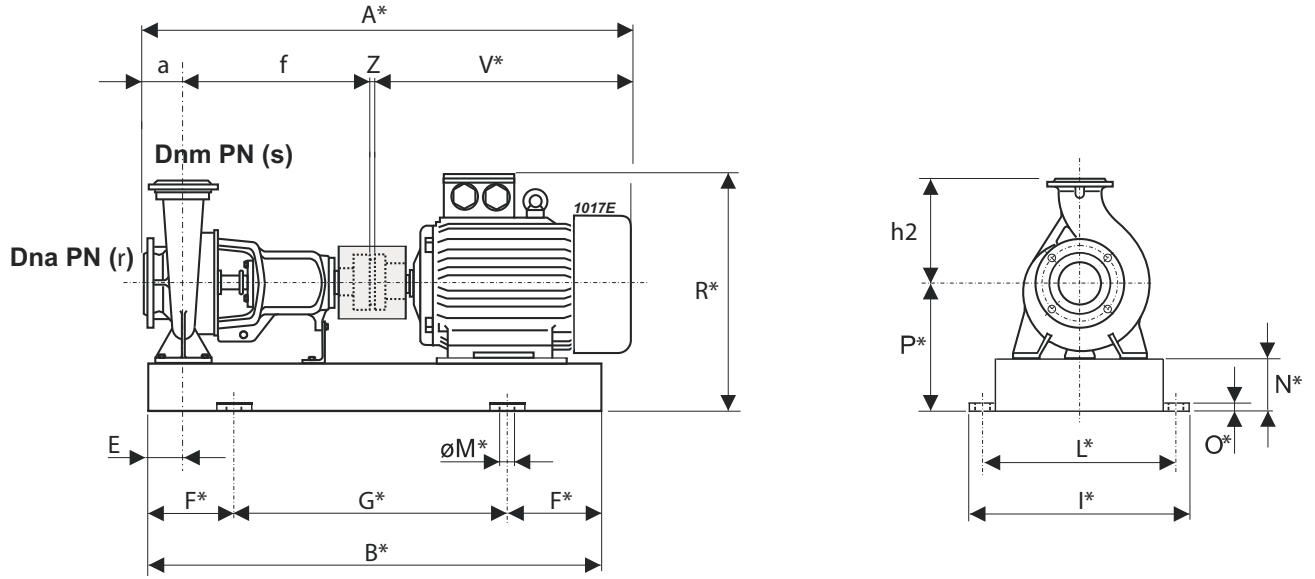

Pump Pompe Pompa			Motor Moteur Motore		BGAN	A *	B *	E	F *	G *	I *	L *	M *	N *	O *	P *	R *	V *	Z	a	f	h2	r	s	Weight Poids Peso	
Type Type Tipo	DNa [mm]	DNm [mm]	[kW]	Size Taille Grand.	Type Type Tipo	[mm]																				
NCH125-400	150	125	11	160L	2045/EY3	1301	1161	110	200	761	630	580	ø 22	160	50	475	726	627	4	140	530	400	16	16	428	
NCH125-400	150	125	15	180L	2046/FY3	1379	1209	110	200	809	630	580	ø 22	160	50	475	745	705	4	140	530	400	16	16	482	
NCH125-400	150	125	18,5	200L	2048/FY3	1432	1282	110	200	882	630	580	ø 22	160	50	475	775	758	4	140	530	400	16	16	524	
NCH125-400	150	125	22	200L	2048/GY3	1432	1282	110	200	882	630	580	ø 22	160	50	475	775	758	4	140	530	400	16	16	540	
NCH125-400	150	125	30	225M	2049/HY4	1492	1310	110	200	910	630	580	ø 22	160	50	475	805	818	4	140	530	400	16	16	659	
NCH125-500	150	125	15	180L	2038/FY3	1539	1404	110	250	904	680	630	ø 22	180	50	535	805	705	4	160	670	450	16	16	700	
NCH125-500	150	125	18,5	200L	2039/FY3	1592	1442	110	250	942	680	630	ø 22	180	50	535	835	758	4	160	670	450	16	16	740	
NCH125-500	150	125	22	200L	2039/GY3	1592	1442	110	250	942	680	630	ø 22	180	50	535	835	758	4	160	670	450	16	16	756	
NCH125-500	150	125	30	225M	2034/HY4	1652	1484	110	250	984	680	630	ø 22	180	50	535	865	818	4	160	670	450	16	16	837	
NCH125-500	150	125	37	250M	2033/HY4	1714	1512	110	250	1012	680	630	ø 22	180	50	535	910	880	4	160	670	450	16	16	907	
NCH125-500	150	125	45	280S	2035/IY4	1854	1559	110	250	1059	680	630	ø 22	180	50	535	925	1020	4	160	670	450	16	16	1090	
NCH200-500	250	200	30	225M	2031/HY4	1932	1779	170	300	1179	890	840	ø 22	200	50	600	930	818	4	225	885	580	16	16	1103	
NCH200-500	250	200	37	250M	2032/HY4	1994	1836	170	300	1236	890	840	ø 22	200	50	600	975	880	4	225	885	580	16	16	1161	
NCH200-500	250	200	45	280S	2030/IY4	2134	1834	170	300	1234	890	840	ø 22	200	50	600	990	1020	4	225	885	580	16	16	1398	
NCH200-500	250	200	55	280M	2027/IY4	2184	1885	170	300	1285	890	840	ø 22	200	50	600	990	1070	4	225	885	580	16	16	1481	
NCH200-500	250	200	75	315S	2028/LY4	2325	1961	170	350	1261	890	840	ø 22	200	50	600	1155	1211	4	225	885	580	16	16	1686	
NCH200-500	250	200	90	315M	2029/LY4	2435	2071	170	350	1371	890	840	ø 22	200	50	600	1155	1321	4	225	885	580	16	16	1815	
NCH250-250	300	250	18,5	200L	2055/HY4	1872	1682	135	300	1082	760	710	ø 22	180	50	535	835	758	4	225	885	560	16	16	721	
NCH250-250	300	250	22	200L	2055/HY4	1872	1682	135	300	1082	760	710	ø 22	180	50	535	835	758	4	225	885	560	16	16	737	
NCH250-500	300	250	45	280S	2042/IY4	2134	1887	170	300	1287	890	840	ø 22	220	50	670	1060	1020	4	225	885	630	16	16	1451	
NCH250-500	300	250	55	280M	2043/IY4	2184	1938	170	300	1338	890	840	ø 22	220	50	670	1060	1070	4	225	885	630	16	16	1535	
NCH250-500	300	250	75	315S	2044/LY4	2325	1961	170	350	1261	890	840	ø 22	220	50	670	1225	1211	4	225	885	630	16	16	1812	
NCH250-500	300	250	90	315M	2041/LY4	2435	2071	170	350	1320	890	840	ø 22	220	50	670	1225	1321	4	225	885	630	16	16	1925	
NCH250-500	300	250	110	315L	2024/MY5	2435	2071	170	350	1371	890	840	ø 22	220	50	670	1225	1321	4	225	885	630	16	16	1995	
NCHF250-500	300	250	45	280S	2042/IY4	2134	1887	170	300	1287	890	840	ø 22	220	50	670	1060	1020	4	225	885	630	16	16	1241	
NCHF250-500	300	250	55	280M	2043/IY4	2184	1938	170	300	1338	890	840	ø 22	220	50	670	1060	1070	4	225	885	630	16	16	1325	
NCHF250-500	300	250	75	315S	2044/LY4	2325	1961	170	350	1261	890	840	ø 22	220	50	670	1225	1211	4	225	885	630	16	16	1812	
NCHF250-500	300	250	90	315M	2041/LY4	2435	2071	170	350	1320	890	840	ø 22	220	50	670	1225	1321	4	225	885	630	16	16	1925	
NCHF250-500	300	250	110	315L	2024/MY5	2435	2071	170	350	1371	890	840	ø 22	220	50	670	1225	1321	4	225	885	630	16	16	1995	

BGAN = Base and coupling      BGAN = Socle et accouplement      BGAN = Base e giunto  
 \* = Indicatives values according to the type of motor installed.      \* = Valeurs indicatives en fonction de la marque du moteur utilisé.      \* = Valori indicativi in funzione della marca di motore utilizzato.  
 ○ Motor in IE4 efficiency class according to EU REGULATION      ○ Moteur en classe de rendement IE4 conformément au RÈGLEM-      ○ Motore in classe di efficienza IE4 in conformità al REGOLAMENTO  
 2019/1781. Available in other efficiency classes for non-EU mar-      ENT UE2019/1781. Disponibilit  en diff rentes classes de rende-      UE2019/1781. Disponibili in altre classi di efficienza per mercati extra  
 kets.      ment pour les march s hors UE.      UE.

Flanges (UNI EN 1092-2)  
 Brides (UNI EN 1092-2)  
 Flange (UNI EN 1092-2)

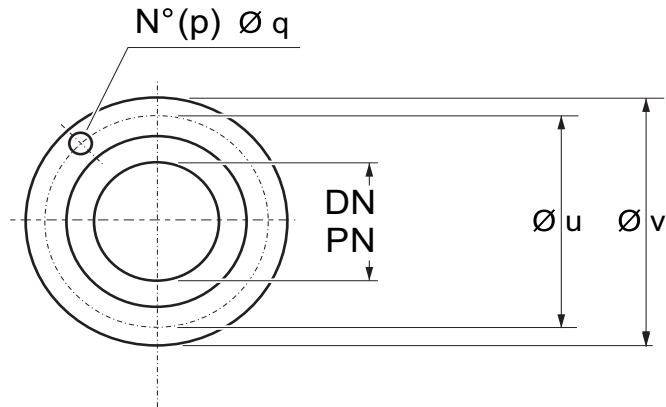

Port $\varnothing$ $\varnothing$ Orifice $\varnothing$ Bocca		Holes Trous Fori		$\varnothing u$	$\varnothing v$
DN	PN	p	q	[mm]	
[mm]	[bar]	No	$\varnothing$ [mm]		
32	16	4	18	100	140
40	16	4	18	110	150
50	16	4	18	125	165
50	25	4	18	125	165
65	16	4	18	145	185
80	16	8	18	160	200
100	16	8	18	180	220
125	16	8	18	210	250
150	16	8	22	240	285
200	16	12	22	295	340
250	16	12	26	355	405
300	16	12	26	410	460





**caprari**

The dimensions have an indicative value. Executive drawing will be supplied on request upon order.  
CAPRARI S.p.A. reserves the right to make changes to improve its products at any time and without any notice

*Les dimensions sont fournies à titre indicatif. Le plan bon pour exécution sera fourni sur demande au moment de la commande.  
CAPRARI S.p.A. se réserve la faculté d'apporter des modifications visant à améliorer ses propres produits à tout moment et sans aucun préavis.*

**Le dimensioni hanno valore indicativo. Il disegno esecutivo sarà fornito su richiesta in fase d'ordine.  
CAPRARI S.p.A. si riserva facoltà di apportare modifiche atte a migliorare i propri prodotti in qualsiasi momento e senza preavviso alcuno.**