

NCD 2P40-200

2900 n [min⁻¹]

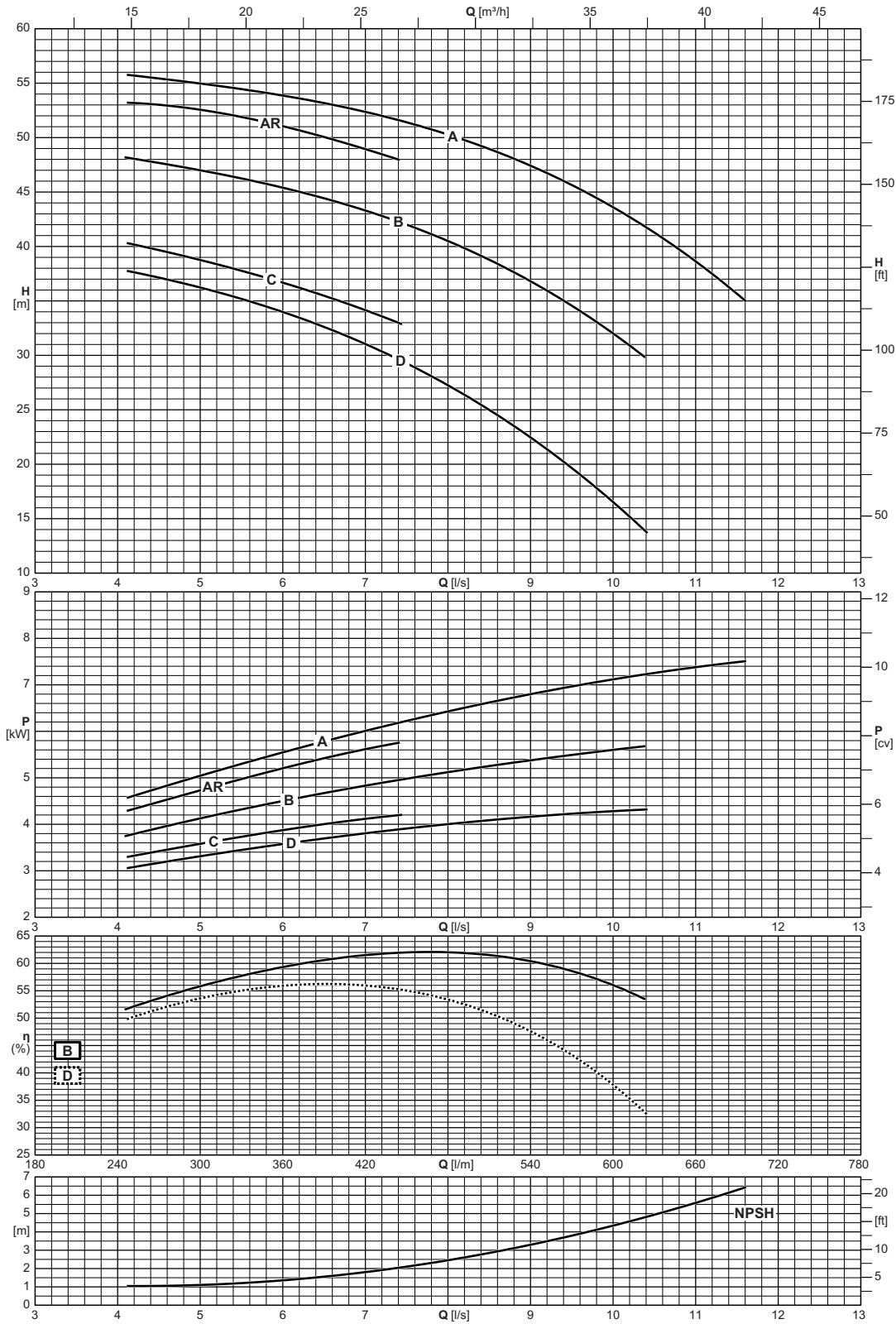

Operating data
Caracteristiques de fonctionnement
Caratteristiche di funzionamento



Type Type Tipo	Inlet maximum pressure Pression maximale en aspiration Pressione massima in aspirazione
NCD2P40-200	[bar] 10

Overall dimensions and weights
 Dimensions d'encombrement et poids
 Dimensioni di ingombro e pesi

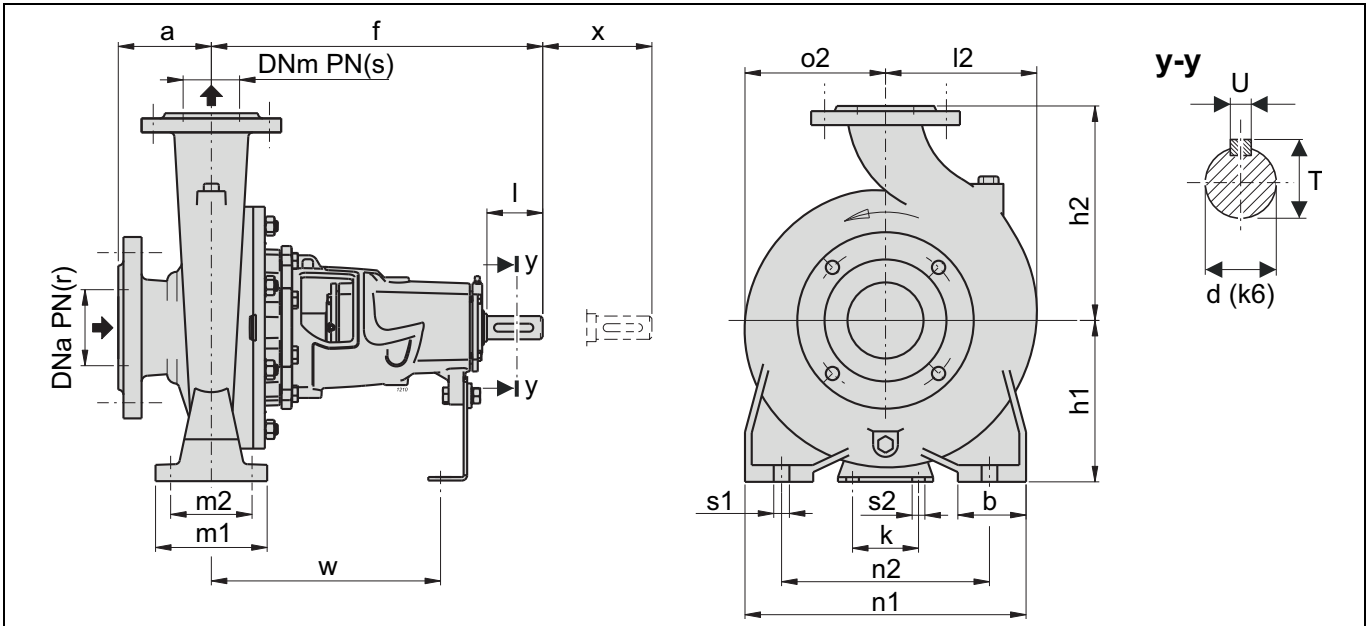

Type Type Tipo	Weight Poids Peso [kg]	Dimensions pump Dimensions pompe Dimensioni pompa										Duck foot pedestal dimensions Dimensiones pieds de soutien Dimensioni piedi di appoggio							Shaft projection Saillie d'arbre Sporgenza d'albero				
		DNa	DNm	r	s	a	f	h1	h2	l2	o2	b	m1	m2	n1	n2	k	w	s1	s2	d	l	T
		[mm]																					
NCD(S)2P32-125	26	50	32	10	10	80	360	112	140	97	93	50	100	70	190	140	110	260	ø 14	ø 14	24	50	50
NCD(S)2P32-160	33	50	32	10	10	80	360	132	160	120	120	50	100	70	240	190	110	260	ø 14	ø 14	24	50	50
NCD(S)2P32L-160	31	50	32	10	10	80	360	132	160	120	120	50	100	70	240	190	110	260	ø 14	ø 14	24	50	50
NCD(S)2P32L-200	40	50	32	10	10	80	360	160	180	140	140	50	100	70	265	212	110	260	ø 14	ø 14	24	50	50
NCD(S)2P32-200	38	50	32	10	10	80	360	160	180	140	140	50	100	70	240	190	110	260	ø 14	ø 14	24	50	50
NCD(S)2P40-125	28	65	40	10	10	80	360	112	140	113	100	50	100	70	210	160	110	260	ø 14	ø 14	24	50	65
NCD(S)2P40-160	33	65	40	10	10	80	360	132	160	119	119	50	100	70	240	190	110	260	ø 14	ø 14	24	50	65
NCD(S)2P40-200	40	65	40	10	10	100	360	160	180	140	140	50	100	70	265	212	110	260	ø 14	ø 14	24	50	65
NCD(S)2P40-250	55	65	40	10	10	100	360	180	225	175	175	65	125	95	320	250	110	260	ø 14	ø 14	24	50	65
NCD(S)2P50-125	34	65	50	10	10	100	360	132	160	137	121	50	100	70	240	190	110	260	ø 14	ø 14	24	50	65
NCD(S)2P50-160	33	65	50	10	10	100	360	160	180	141	127	50	100	70	265	212	110	260	ø 14	ø 14	24	50	65
NCD(S)2P50-200	44	65	50	10	10	100	360	160	200	153	140	50	100	70	265	212	110	260	ø 14	ø 14	24	50	65
NCD(S)2P50-250	57	65	50	10	10	100	360	180	225	175	175	65	125	95	320	250	110	260	ø 14	ø 14	24	50	65
NCD(S)2P65-125	38	80	65	10	10	100	360	160	180	155	134	65	125	95	280	212	110	260	ø 14	ø 14	24	50	80
NCD(S)2P65-160	40	80	65	10	10	100	360	160	200	172	150	65	125	95	280	212	110	260	ø 14	ø 14	24	50	80
NCD(S)2P65-200	48	80	65	10	10	100	360	180	225	175	155	65	125	95	320	250	110	260	ø 14	ø 14	24	50	80
NCD(S)2P65-250	88	80	65	10	10	100	470	200	250	190	175	80	160	120	360	280	110	340	ø 18	ø 14	24	50	80
NCD(S)2P80-160	48	100	80	10	10	125	360	180	225	193	165	65	125	95	320	250	110	260	ø 14	ø 14	24	50	100
NCD(S)2P80-200	80	100	80	10	10	125	470	180	250	194	170	65	125	95	345	280	110	340	ø 14	ø 14	32	80	100
NCD(S)2P80-250	92	100	80	10	10	125	470	200	280	210	191	80	160	120	400	315	110	340	ø 18	ø 14	32	80	100
NCD(S)2P100-200	83	125	100	10	10	125	470	200	280	212	180	80	160	120	360	280	110	340	ø 18	ø 14	32	80	125
NCD(S)2P100-250	103	125	100	10	10	140	470	225	280	233	205	80	160	120	400	315	110	340	ø 18	ø 14	32	80	125
NCD(S)4P32-125	25	50	32	10	10	80	360	112	140	97	93	50	100	70	190	140	110	260	ø 14	ø 14	24	50	50
NCD(S)4P32-160	33	50	32	10	10	80	360	132	160	120	120	50	100	70	240	190	110	260	ø 14	ø 14	24	50	50
NCD(S)4P32-200	37	50	32	10	10	80	360	160	180	140	140	50	100	70	240	190	110	260	ø 14	ø 14	24	50	50
NCD(S)4P40-160	33	65	40	10	10	80	360	132	160	119	119	50	100	70	240	190	110	260	ø 14	ø 14	24	50	65
NCD(S)4P40-200	40	65	40	10	10	100	360	160	180	140	140	50	100	70	265	212	110	260	ø 14	ø 14	24	50	65
NCD(S)4P40-250	55	65	40	10	10	100	360	180	225	175	175	65	125	95	320	250	110	260	ø 14	ø 14	24	50	65
NCD(S)4P50-125	34	65	50	10	10	100	360	132	160	137	121	50	100	70	240	190	110	260	ø 14	ø 14	24	50	65
NCD(S)4P50-160	33	65	50	10	10	100	360	160	180	141	127	50	100	70	265	212	110	260	ø 14	ø 14	24	50	65
NCD(S)4P50-200	44	65	50	10	10	100	360	160	200	153	140	50	100	70	265	212	110	260	ø 14	ø 14	24	50	65
NCD(S)4P50-250	57	65	50	10	10	100	360	180	225	175	175	65	125	95	320	250	110	260	ø 14	ø 14	24	50	65
NCD(S)4P65-125	38	80	65	10	10	100	360	160	180	155	134	65	125	95	280	212	110	260	ø 14	ø 14	24	50	80
NCD(S)4P65-160	40	80	65	10	10	100	360	160	200	172	150	65	125	95	280	212	110	260	ø 14	ø 14	24	50	80
NCD(S)4P65-200	48	80	65	10	10	100	360	180	225	175	155	65	125	95	320	250	110	260	ø 14	ø 14	24	50	80
NCD(S)4P65-250	89	80	65	10	10	100	470	200	250	190	175	80	160	120	360	280	110	340	ø 18	ø 14	24	50	80
NCD(S)4P65-315	131	80	65	10	10	125	470	225	280	220	220	80	160	120	400	315	110	340	ø 18	ø 14	32	80	80
NCD(S)4P80-160	48	100	80	10	10	125	360	180	225	193	165	65	125	95	320	250	110	260	ø 14	ø 14	24	50	100
NCD(S)4P80-200	80	100	80	10	10	125	470	180	250	194	170	65	125	95	345	280	110	340	ø 14	ø 14	32	80	100
NCD(S)4P80-250	92	100	80	10	10	125	470	200	280	210	191	80	160	120	400	315	110	340	ø 18	ø 14	32	80	100
NCD(S)4P80-315	128	100	80	10	10	125	470	250	315	232	220	80	160	120	400	315	110	340	ø 18	ø 14	32	80	100
NCD(S)4P80-400	184	100	80	10	10	125	530	280	355	268	268	80	160	120	435	355	110	370	ø 18	ø 14	42	110	100
NCD(S)4P100-200	83	125	100	10	10	125	470	200	280	212	180	80	160	120	360	280	110	340	ø 18	ø 14	32	80	125
NCD(S)4P100-250	103	125	100	10	10	140	470	225	280	233	205	80	160	120	400	315	110	340	ø 18	ø 14	32	80	125
NCD(S)4P100-315	138	125	100	10	10	140	470	250	315	250	230	80	160	120	400	315	110	340	ø 18	ø 14	32	80	125

Selection - dimensions and weights for base mounted electric pumps
 Sélection - dimensions et poids des électropompes sur socle
 Selezione - dimensioni e pesi elettropompe su base

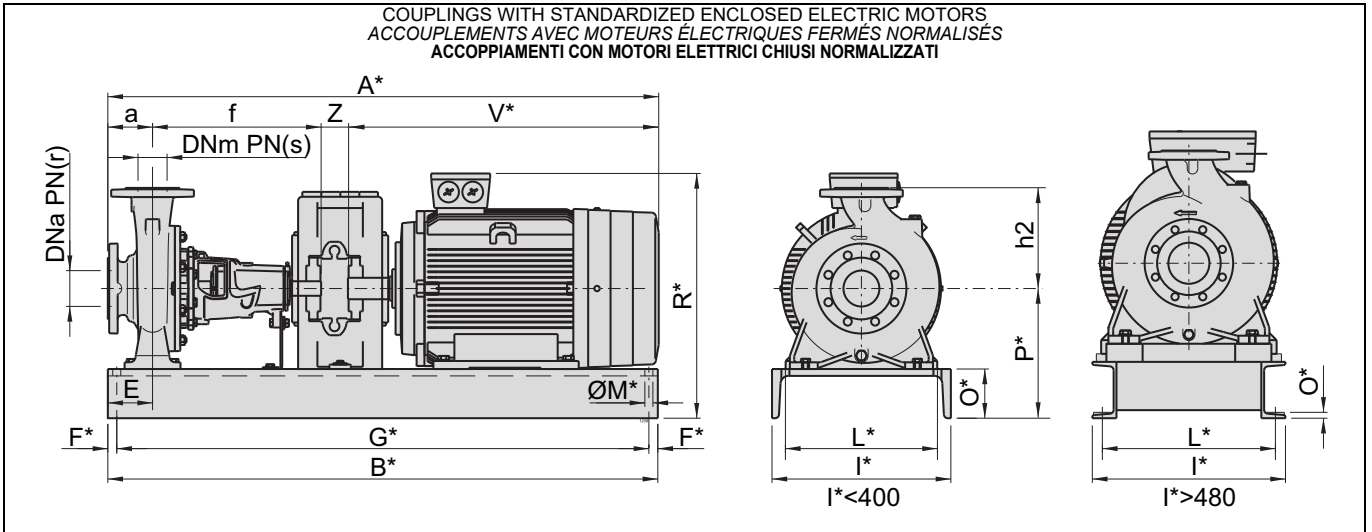

Pump Pompe Pompa		Motor Moteur Motore		Weight Poids Peso	BGAD	A *	B *	E	F *	G *	I *	L *	M *	O *	P *	R *	V *	Z	a	f	h2	r	s		
Type Type Tipo	DNa [mm]	DNm [mm]	[kW]	Size Taille Grand.	[kg]	Type Type Tipo	[mm]																		
NCD2P32-125	50	32	1,1	80M2	68	1002	773	780	90	15	750	240	180	∅ 14	85	197	322	295	38	80	360	140	10	10	
NCD2P32-125	50	32	1,5	90S2	72	1003	833	780	90	15	750	240	180	∅ 14	85	197	335	355	38	80	360	140	10	10	
NCD2P32-160	50	32	2,2	90L2	81	1004	863	780	90	15	750	240	180	∅ 14	85	217	355	385	38	80	360	160	10	10	
NCD2P32-160	50	32	3	100L2	107	1006	894	880	90	15	850	300	240	∅ 14	100	232	382	405	49	80	360	160	10	10	
NCD2P32L-160	50	32	4	112M2	107	1007	929	880	90	15	850	300	240	∅ 14	100	232	404	440	49	80	360	160	10	10	
NCD2P32-200	50	32	4	112M2	115	1012	929	880	90	15	850	300	240	∅ 14	100	260	432	440	49	80	360	180	10	10	
NCD2P32-200	50	32	5,5	132S2	151	1013	943	1020	100	15	990	350	290	∅ 14	100	260	452	455	48	80	360	180	10	10	
NCD2P32L-200	50	32	7,5	132S2	158	1013	943	1020	100	15	990	350	290	∅ 14	100	260	452	455	48	80	360	180	10	10	
NCD2P40-125	65	40	2,2	90L2	77	1015	863	780	90	15	750	240	180	∅ 14	85	197	335	385	38	80	360	140	10	10	
NCD2P40-160	65	40	4	112M2	109	1007	929	880	90	15	850	300	240	∅ 14	100	232	404	440	49	80	360	160	10	10	
NCD2P40-160	65	40	5,5	132S2	142	1017	943	1020	90	15	990	350	290	∅ 14	100	232	424	455	48	80	360	160	10	10	
NCD2P40-200	65	40	7,5	132S2	158	1019	963	1020	100	15	990	350	290	∅ 14	100	260	452	455	48	100	360	180	10	10	
NCD2P40-250	65	40	15	160M2	266	1021	1105	1020	100	15	990	350	290	∅ 14	100	280	531	627	18	100	360	225	10	10	
NCD2P50-125	65	50	4	112M2	110	1007	949	880	90	15	850	300	240	∅ 14	100	232	404	440	49	100	360	160	10	10	
NCD2P50-160	65	50	7,5	132S2	152	1019	963	1020	100	15	990	350	290	∅ 14	100	260	452	455	48	100	360	180	10	10	
NCD2P50-200	65	50	11	160M2	233	1024	1105	1020	100	15	990	350	290	∅ 14	100	260	511	627	18	100	360	200	10	10	
NCD2P50-250	65	50	18,5	160L2	280	1021	1105	1020	100	15	990	350	290	∅ 14	100	280	531	627	18	100	360	225	10	10	
NCD2P65-125	80	65	7,5	132S2	157	1019	963	1020	100	15	990	350	290	∅ 14	100	260	452	455	48	100	360	180	10	10	
NCD2P65-160	80	65	15	160M2	241	1024	1105	1020	100	15	990	350	290	∅ 14	100	260	511	627	18	100	360	200	10	10	
NCD2P65-200	80	65	22	180M2	315	1026	1185	1140	100	15	1110	350	290	∅ 14	100	280	550	665	60	100	360	225	10	10	
NCD2P65-250	80	65	37	200L2	470	1031	1365	1360	130	20	1320	400	340	∅ 18	110	310	610	738	57	100	470	250	10	10	
NCD2P80-160	100	80	18,5	160L2	270	1021	1130	1020	100	15	990	350	290	∅ 14	100	280	531	627	18	125	360	225	10	10	
NCD2P80-250	100	80	55	250M2	611	1042	1492	1250	95	205	840	480	430	∅ 24	16	415	790	870	27	125	470	280	10	10	
NCD2P100-200	125	100	45	225M2	507	1050	1427	1250	95	205	840	480	430	∅ 24	16	385	715	775	57	125	470	280	10	10	
NCD2P100-250	125	100	75	280S2	834	1052	1637	1400	95	230	940	510	450	∅ 24	17,5	505	900	1000	27	140	470	280	10	10	

BGAD = Base and coupling BGAD = Socle et accouplement BGAD = Base e giunto
 * = Indicatives values according to the type of motor installed. * = Valeurs indicatives en fonction de la marque du moteur utilisé. * = Valori indicativi in funzione della marca di motore utilizzato.
 ○ Motor in IE4 efficiency class according to EU REGULATION 2019/1781. Available in other efficiency classes for non-EU markets. ○ Moteur en classe de rendement IE4 conformément au RÈGLEMENT UE2019/1781. Disponibilité en différentes classes de rendements pour les marchés hors UE. ○ Motore in classe di efficienza IE4 in conformità al REGOLAMENTO UE2019/1781. Disponibili in altre classi di efficienza per mercati extra UE.