

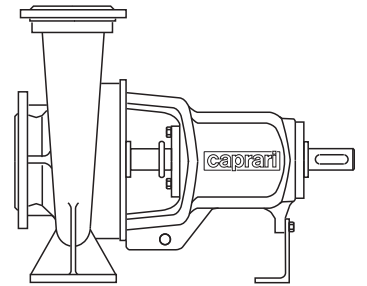

NORM SINGLE-STAGE
PUMPS -EN733 (DIN 24255)
*POMPES MONOCELLULAIRES
NORMALISEES - EN733 (DIN 24255)*
**POMPE MONOGIRANTI
NORMALIZZATE - EN733
(DIN 24255)**

NCD



caprari

pumping power



	Page - Page - Pagina
• Technical data <i>Données techniques</i> Dati tecnici	3
• Pump coding <i>Identification du sigle</i> Esemplificazione sigla	4
• Performance ranges <i>Champs de performances</i> Campi di prestazione	5
• Operating limits <i>Limites de fonctionnement</i> Limiti di funzionamento	6
• Pump construction and materials <i>Construction de la pompe et matériels</i> Costruzione pompa e materiali	7
• Technical data standardized enclosed electric motors - 50Hz <i>Données techniques moteurs électriques fermés - 50Hz</i> Dati tecnici motore elettrico chiuso normalizzato - 50Hz	8
• Performances curves at 1450 n [min-1] <i>Caractéristiques de fonctionnement à 1450 n [min-1]</i> Caratteristiche di funzionamento a 1450 n [min-1]	9
• Performances curves at 1750 n [min-1] <i>Caractéristiques de fonctionnement à 1750 n [min-1]</i> Caratteristiche di funzionamento a 1750 n [min-1]	38
• Performances curves at 2900 n [min-1] <i>Caractéristiques de fonctionnement à 2900 n [min-1]</i> Caratteristiche di funzionamento a 2900 n [min-1]	65
• Performances curves at 3450 n [min-1] <i>Caractéristiques de fonctionnement à 3450 n [min-1]</i> Caratteristiche di funzionamento a 3450 n [min-1]	87
• Overall dimensions and weights <i>Dimensions d'encombrement et poids</i> Dimensioni di ingombro e pesi	109
• Selection - Dimensions and weights for base mounted electric pumps 2P / 50Hz <i>Sélection - Dimensions et poids des électropompes sur socle 2P / 50Hz</i> Selezione - Dimensioni e pesi elettropompe su base 2P / 50Hz	111
• Selection - Dimensions and weights for base mounted electric pumps 2P / 60Hz <i>Sélection - Dimensions et poids des électropompes sur socle 2P / 60Hz</i> Selezione - Dimensioni e pesi elettropompe su base 2P / 60Hz	112
• Selection - Dimensions and weights for base mounted electric pumps 4P / 50Hz <i>Sélection - Dimensions et poids des électropompes sur socle 4P / 50Hz</i> Selezione - Dimensioni e pesi elettropompe su base 4P / 50Hz	113
• Selection - Dimensions and weights for base mounted electric pumps 4P / 60Hz <i>Sélection - Dimensions et poids des électropompes sur socle 4P / 60Hz</i> Selezione - Dimensioni e pesi elettropompe su base 4P / 60Hz	114
Flanges (UNI EN 1092-2) - <i>Brides (UNI EN 1092-2)</i> - Flange (UNI EN 1092-2)	115

GENERAL INFORMATION

Single-stage horizontal shaft pumps with main dimensions and characteristics conforming to EN733 (DIN 24255) standards.

- Pump casing: volute type with flanged delivery port.
- Impeller: high efficiency closed type with balanced axial thrust.
Available in either cast iron or bronze.
- Shaft and supports:
the AISI 430 stainless steel shaft (fully protected against contact with the pumped water) is guided and supported by two ball bearings housed in the connecting support that are permanently lubricated with high quality grease to guarantee longer life.
- Seal:
the mechanical type, housed in the connecting support and easily replaceable.
- Coupling to the motor
the NCD series pumps can be coupled to IP 55 standard electric motors with B3 motor mounting. The pumps can be coupled to high-efficiency motors. The BACK PULL OUT constructional concept, connection to the motor with a flexible coupling and spacer, available on request, allow the wet end to be disassembled from the rear for inspection purposes and repairs without disconnecting the motor or the pump casing from the piping.
- Direction of rotation:
clockwise viewed from drive side.
- Port positioning: axial for suction / radial delivery port pointing upwards.

APPLICATIONS

The NCD series standardized pumps have been designed for several applications, such as fire-fighting, industrial water supply, industrial uses, anti-frost protection, irrigation, medium and large heating and air conditioning systems and water supply for both civil and industrial uses.

LIMITS

- Max. temperature of pumped liquid: +90°C (special versions on request +140°C)
- Min. temperature of pumped liquid: -10°C.
- Max operating time with closed discharge and liquid at 90°C: 30 sec.
- Nominal pressure 10/16 bar (with flanging conforming to UNI 2223 PN16/PN25).
- The pumps can operate with all fluids chemically and mechanically compatible with the pump materials.

Special versions can be supplied on request.

CARACTÉRISTIQUES

Pompes monocellulaires à axe horizontal avec caractéristiques et dimensions principales normalisées EN733 (DIN 24255).

- *Corps de pompe : type à volute avec orifice de refoulement à bride.*
- *Roue : de type fermé à haut rendement, avec équilibrage e la poussée axiale. Disponible en fonte ou en bronze.*
- *Arbre et paliers:
l'arbre en acier inoxydable AISI 430, (totalement protégé du contact avec l'eau pompée) est guidé et soutenu par deux roulements à billes logés dans le palier de liaison à lubrification permanente par de la graisse haute qualité, en garantie d'une très longue durée.*
- *Garniture:
de type mécanique logée dans le palier de liaison et facile à remplacer.*
- *Accouplement au moteur
les pompes série NCD peuvent être accouplées à des moteurs électriques suivant le standard IP 55 dans la forme de construction B3; la pompe peut être accouplée à des moteurs à haut rendement. Le principe de fabrication «BACK PULL OUT» ainsi que l'accouplement au moteur par joint élastique et entretoise d'espacement sur demande permettent de démonter la partie hydraulique par l'arrière pour les contrôles techniques ou la réparation, sans débrancher le moteur et le corps de la pompe des tuyauteries.*
- *Sens de rotation :*
horaire vu côté commande.
- *Orientation des orifices : aspiration axiale / orifice de refoulement radiale tourné vers le haut.*

APPLICATIONS

Les pompes normalisées série NCD ont été conçues pour de nombreux secteurs d'activité : anti-incendie, réseaux industriels de distribution d'eau, anti-gel, irrigation, installations moyennes et grandes de chauffage et de conditionnement, alimentation en eau potable à usage civil et industriel.

LIMITES D'EMPLOI

- *Température max. du liquide pompé : +90°C (des versions spéciales sur demande +140°C)*
- *Température min. du liquide pompé : -10°C*
- *Temps max. de fonctionnement à refoulement fermé avec liquide à 90°C: 30 s.*
- *Pression nominale 10/16 bar (avec brides normalisées UNI 2223 PN16/PN25).*
- *Possibilité de véhiculer de nombreux liquides chimiquement et mécaniquement agressifs, compatibles avec les matériaux constitutifs des pompes.*

Des versions spéciales peuvent être fournies sur demande.

CARATTERISTICHE

Pompe monogiranti ad asse orizzontale con caratteristiche e dimensioni principali secondo le norme EN733 (DIN 24255).

- **Corpo pompa:** del tipo a voluta con bocca premente flangiata.
- **Girante:** del tipo chiuso ad elevato rendimento, con equilibratura della spinta assiale.
Disponibile in ghisa o bronzo.
- **Albero e supporti:**
l'albero in acciaio inossidabile AISI 430, (totalmente protetto dal contatto con l'acqua pompata) è guidato e sostenuto da due cuscinetti a sfere alloggiati nel supporto di collegamento e lubrificati a grasso permanente di alta qualità a garanzia di una più lunga durata.
- **Tenuta:**
di tipo meccanico alloggiata nel supporto di collegamento e facilmente sostituibile.
- **Accoppiamento al motore**
le pompe serie NCD, possono essere accoppiate a motori elettrici standard IP 55 in forma costruttiva B3; le pompe possono essere accoppiate a motori ad alto rendimento.
Il concetto costruttivo BACK PULL OUT e l'accoppiamento al motore con giunto elastico e distanziale spaziatore su richiesta consentono lo smontaggio posteriore della parte idraulica per l'ispezione o la riparazione, senza sconnettere il motore ed il corpo pompa dalle tubazioni.
- **Senso di rotazione:**
orario visto dal lato comando.
- **Orientamento bocche:** aspirante assiale / premente radiale rivolta verso l'alto.

APPLICAZIONI

Le pompe normalizzate serie NCD sono state studiate per i settori di utilizzo quali antincendio, acquedottistica, industriale, antibrina, irrigazione, impianti di riscaldamento e condizionamento di medie e grandi dimensioni e approvvigionamento idrico sia ad uso civile che industriale.

LIMITI D'IMPIEGO

- **Temperatura max. liquido sollevato:** +90°C. (esecuzione su richiesta +140°C.)
- **Temperatura min. liquido sollevato:** -10°C.
- **Tempo max di funzionamento a bocca chiusa con liquido a 90°C:** 30 sec.
- **Pressione nominale 10/16 bar (con flangiature secondo UNI 2223 PN16/PN25).**
- **Possibilità di veicolamento di tutti quei liquidi chimicamente e meccanicamente compatibili con i materiali costruttivi delle pompe.**

Su richiesta possono essere fornite esecuzioni speciali.

PUMP CODING
IDENTIFICATION DU SIGLE
ESEMPLIFICAZIONE SIGLA

Code - Désignation - Sigla
NCD4P50-250

Series NCD (with Cast Iron impeller)
Séries NCD (Avec roue en fonte grise)
Serie NCD (con girante in ghisa)

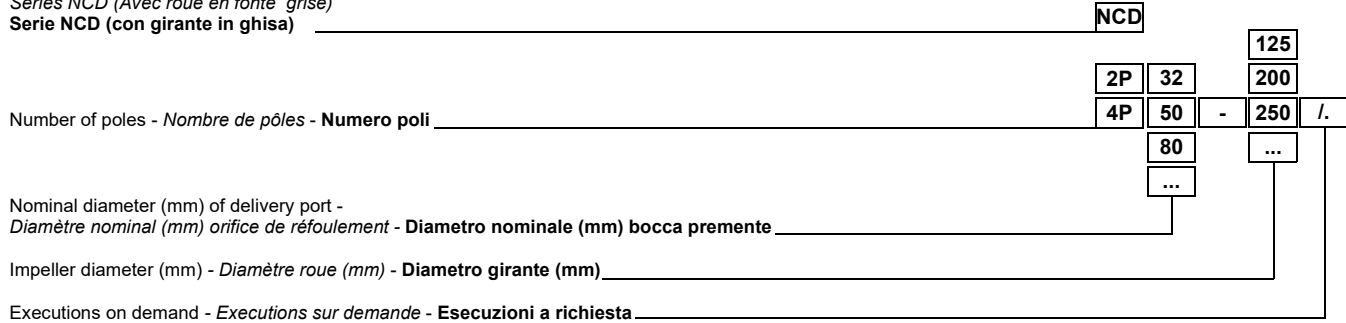

MECHANICAL SEAL

ÉTANCHÉITÉ MÉCANIQUE

TENUTA MECCANICA

Component / Particulier / Particolare				
Type Type Tipo	Ressort Spring Molla	Joints Gaskets Guarnizioni	Static seat Grain fixe Anello fisso	Rotatic seat Grain tournant Anello rotante
Material/ Matériel / Materiale				
Standard	AISI 316	EPDM	SILICON CARBIDE CARBURE DE SILICIUM CARBURO DI SILICIO	SILICON CARBIDE CARBURE DE SILICIUM CARBURO DI SILICIO

PUMPED LIQUID

Conforming to : DIN 24960 - ISO 3069.

TOLERANCES

Service conditions have been measured with cold water (15°C - 59°F) at 1 bar atmospheric pressure. These tolerances are guaranteed with standard assembly line pumps built according to UNI/ISO 9906 Grade 3B. Catalogue data are for liquids with a density of 1 kg/dm³, and kinematic viscosity not exceeding 1 mm²/s.

LIQUIDE À POMPER

Normalisé : DIN 24960 - ISO 3069.

TOLERANCES

Les caractéristiques de fonctionnement ont été mesurées avec de l'eau froide (15°C) à la pression atmosphérique (1bar). Comme il s'agit de pompes construites en séries, elles sont garanties selon les normes UNI/ISO 9906 Niveau 3B. Les données du catalogue se réfèrent à des liquides ayant une densité de 1 kg/dm³ et une viscosité cinématique qui ne dépasse pas 1 mm²/s.

LIQUIDO DA SOLLEVARE

Secondo le norme : DIN 24960 - ISO 3069.

TOLLERANZE

Le caratteristiche di funzionamento sono state rilevate con acqua fredda (15°C) alla pressione atmosferica (1bar) e vengono garantite, trattandosi di pompe costruite in serie, secondo le norme UNI/ISO 9906 grado 3B. I dati di catalogo si riferiscono a liquidi con densità di 1kg/dm³ e con viscosità cinematica non superiore a 1mm²/s.

Performance ranges
Champs de performance
Campi di prestazione

Performance curves at 50Hz / Caractéristiques de fonctionnement à 50Hz / Caratteristiche di funzionamento a 50Hz

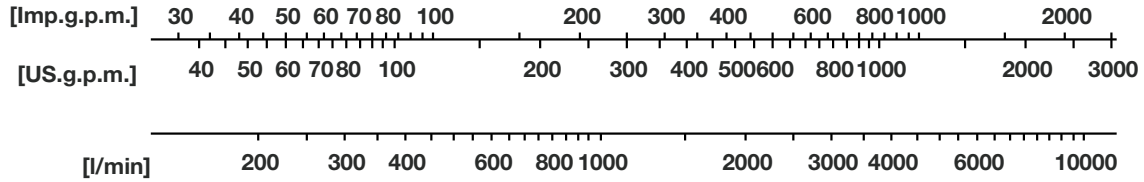
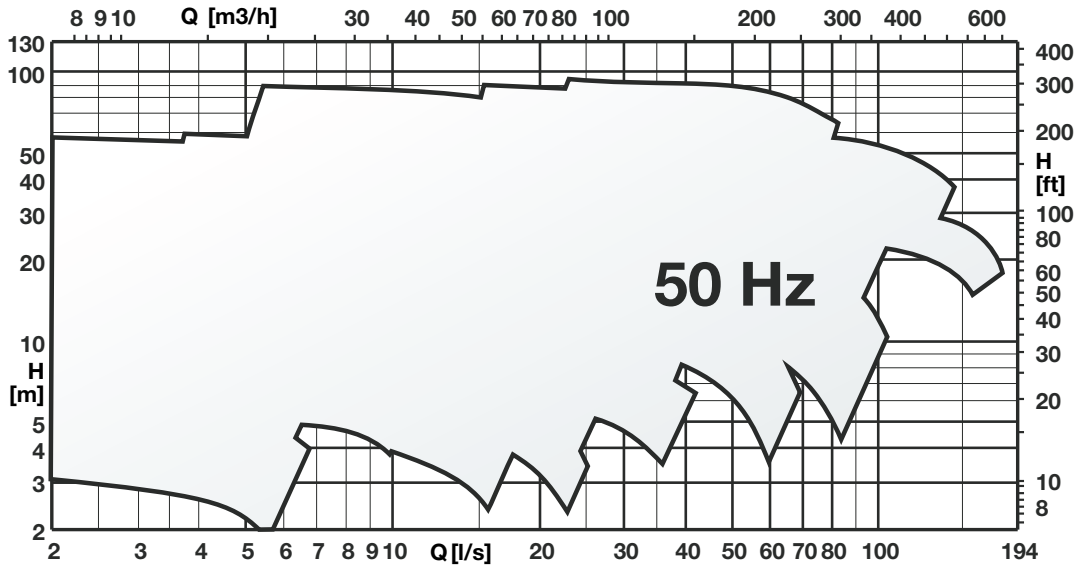

Performance curves at 60Hz / Caractéristiques de fonctionnement à 60Hz / Caratteristiche di funzionamento a 60Hz

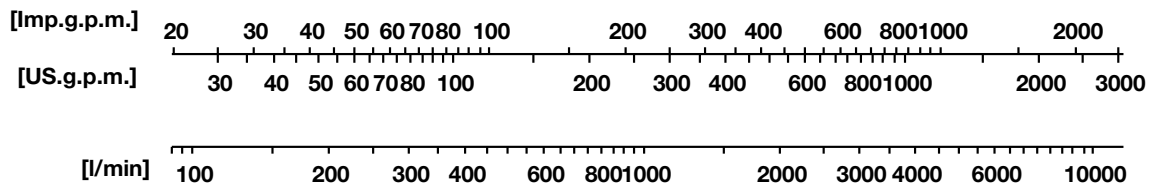
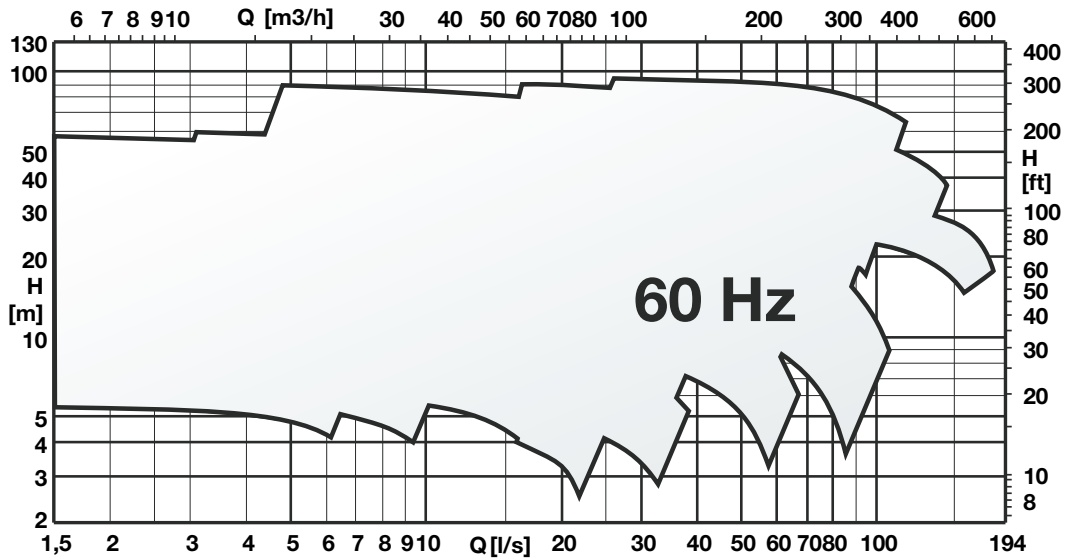

*Parameters not covered by EN733 (DIN24255): see performance fields / *Tailles non prévues en EN733 (DIN24255): Voir plages de performance / Grandezze non previste in EN733 (DIN24255): vedi campi di prestazione*

OPERATING LIMITS / *LIMITES DE FONCTIONNEMENT* / **LIMITI DI FUNZIONAMENTO**

Maximum speed <i>Vitesse maximum</i> Velocità massima	[min ⁻¹]	Maximum speed <i>Vitesse maximum</i> Velocità massima	[min ⁻¹]		
NCD4P32-125	1450	NCD2P32-125	2900		
NCD4P32-160					
NCD4P32-200					
NCD4P40-160					
NCD4P40-200					
NCD4P40-250					
NCD4P50-125					
NCD4P50-160					
NCD4P50-200					
NCD4P50-250					
NCD4P65-125					
NCD4P65-160					
NCD4P65-200					
NCD4P65-250					
NCD4P65-315					
NCD4P80-160					
NCD4P80-200					
NCD4P80-250					
NCD4P80-315					
NCD4P80-400					
NCD4P100-200					
NCD4P100-250					
NCD4P100-315					
NCD4P100-400					
NCD4P125-250					
NCD4P125-315					
NCD4P125-400					
NCD4P150-315					
NCD4P150-400					
NCDS4P32-160		1750		NCDS2P32-125	3450
NCDS4P32-200					
NCDS4P40-160					
NCDS4P40-200					
NCDS4P40-250					
NCDS4P50-160					
NCDS4P50-200					
NCDS4P50-250					
NCDS4P65-125					
NCDS4P65-160					
NCDS4P65-200					
NCDS4P65-250					
NCDS4P65-315					
NCDS4P80-160					
NCDS4P80-200					
NCDS4P80-250					
NCDS4P80-315					
NCDS4P80-400					
NCDS4P100-200					
NCDS4P100-250					
NCDS4P100-315					
NCDS4P100-400					
NCDS4P125-250					
NCDS4P125-315					
NCDS4P125-400					
NCDS4P150-315					
NCDS4P150-400					

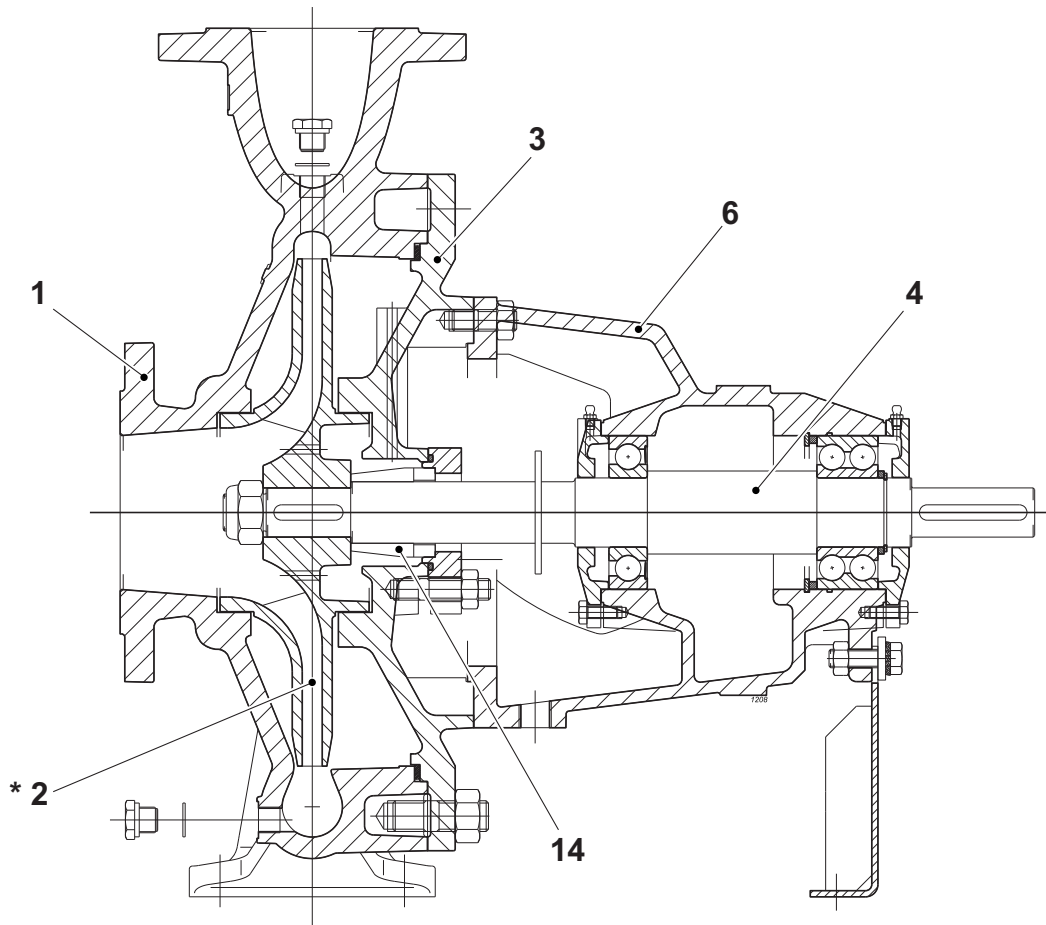

Pos.	Parts	Materials	Nomenclature	Matériaux	Nomenclatura	Materiale
1	Pump casing	Cast iron	Corps de pomp	Fonte grise	Corpo pompa	Ghisa grigia
2*	Impeller	Cast iron	Roue	Fonte grise	Girante	Ghisa grigia
3	Lantern bracket	Cast iron	Lanterne-support	Fonte grise	Supporto di collegamento	Ghisa grigia
4	Shaft	Stainless steel	Arbre	Acier inox	Albero	Acciaio inox
6	Support	Cast iron	Support	Fonte grise	Supporto	Ghisa grigia
14	Mechanical seal	Carbon/Ceramic/ Rubber	Garniture mécanique	Charbon/Céramique/ Caoutchouc	Tenuta meccanica	Carbone/Ceramica/ Gomma

Screws and nuts in stainless steel.

* The sizes 32-125, 32-160, 32L-200 and 40-200 have a bronze impeller.

Vis et écrous en acier inox.

* Les tailles 32-125, 32-160, 32L-200 et 40-200 ont une roue en bronze.

Viti e dadi in acciaio inox

* Le grandezze 32-125, 32-160, 32L-200 e 40-200 hanno la girante in bronzo.

Technical data standardized enclosed electric motors (Indicatives values according to the type of motor installed)
 Données techniques moteurs électriques fermés normalisés (Valeurs indicatives en fonction de la marque du moteur utilisé)
 Dati tecnici motore elettrico chiuso normalizzato (Valori indicativi in funzione della marca di motore utilizzato)

Motor power Puiss. moteur Potenza motore	2 Poles 50 Hz 2 Pôles 50 Hz 2 Poli 50 Hz			4 Poles 50 Hz 4 Pôles 50 Hz 4 Poli 50 Hz		
	Max. number starts/hour* Nombre maxi. de démarrages/heure Numero massimo di avviamenti/ora	Voltage variation Variation de tension Variazione di tensione	Dinamic momentum J Momentum dynamique J Momento dinamico J	Max. number starts/hour* Nombre maxi. de démarrages/heure Numero massimo di avviamenti/ora	Voltage variation Variation de tension Variazione di tensione	Dinamic momentum J Momentum dynamique J Momento dinamico J
[kW]		[%]	[kg m²]		[%]	[kg m²]
0,75	3	± 10 (400V)	0,001	3	± 10 (400V)	0,003
1,1	3	± 10 (400V)	0,002	3	± 10 (400V)	0,004
1,5	3	± 10 (400V)	0,002	3	± 10 (400V)	0,005
2,2	3	± 10 (400V)	0,003	3	± 10 (400V)	0,01
3	3	± 10 (400V)	0,005	3	± 10 (400V)	0,013
4	3	± 10 (400V)	0,008	3	± 10 (400V)	0,02
5,5	3	± 10 (400V)	0,014	3	± 10 (400V)	0,035
7,5	3	± 10 (400V)	0,017	3	± 10 (400V)	0,047
11	3	± 10 (400V)	0,051	3	± 10 (400V)	0,107
15	3	± 10 (400V)	0,064	3	± 10 (400V)	0,129
18,5	3	± 10 (400V)	0,076	3	± 10 (400V)	0,19
22	3	± 10 (400V)	0,117	3	± 10 (400V)	0,226
30	3	± 10 (400V)	0,174	3	± 10 (400V)	0,361
37	3	± 10 (400V)	0,205	3	± 10 (400V)	0,63
45	3	± 10 (400V)	0,302	3	± 10 (400V)	0,738
55	3	± 10 (400V)	0,408	3	± 10 (400V)	1,024
75 ○	3	± 10 (400V)	0,677	3	± 10 (400V)	1,4723

- Axial drive only, by flexible coupling.
 - Electric motor operating limits in compliance with IEC 34-1

- Entraînement seulement coaxial par accouplement élastique.
 - Limites de fonctionnement pour le moteur électriques suivant les IEC 34-1

- Azionamento solo coassiale tramite giunto elastico.
 - Limiti d'utilizzo motore elettrico secondo IEC 34-1.

* Equally distributed.
 *. = Contact the sales network

* Conseillés uniformément repartis.
 *. = Contacter le réseau de vente

* Consigliati equamente ripartiti.
 *. = Contattare la rete di vendita

SPECIFICATIONS
 Efficiency class: IE3

CARACTÉRISTIQUE[
 Classe de rendement: IE3

CARATTERISTICHE)
 Classe di efficienza: IE3

○ Motor in IE4 efficiency class according to EU REGULATION 2019/1781. Available in other efficiency classes for non-EU markets.

○ Moteur en classe de rendement IE4 conformément au RÈGLEMENT UE2019/1781. Disponibilité en différentes classes de rendement pour les marchés hors UE.

○ Motore in classe di efficienza IE4 in conformità al REGOLAMENTO UE2019/1781. Disponibili in altre classi di efficienza per mercati extra UE.

Operating data
 Caracteristiques de fonctionnement
 Caratteristiche di funzionamento

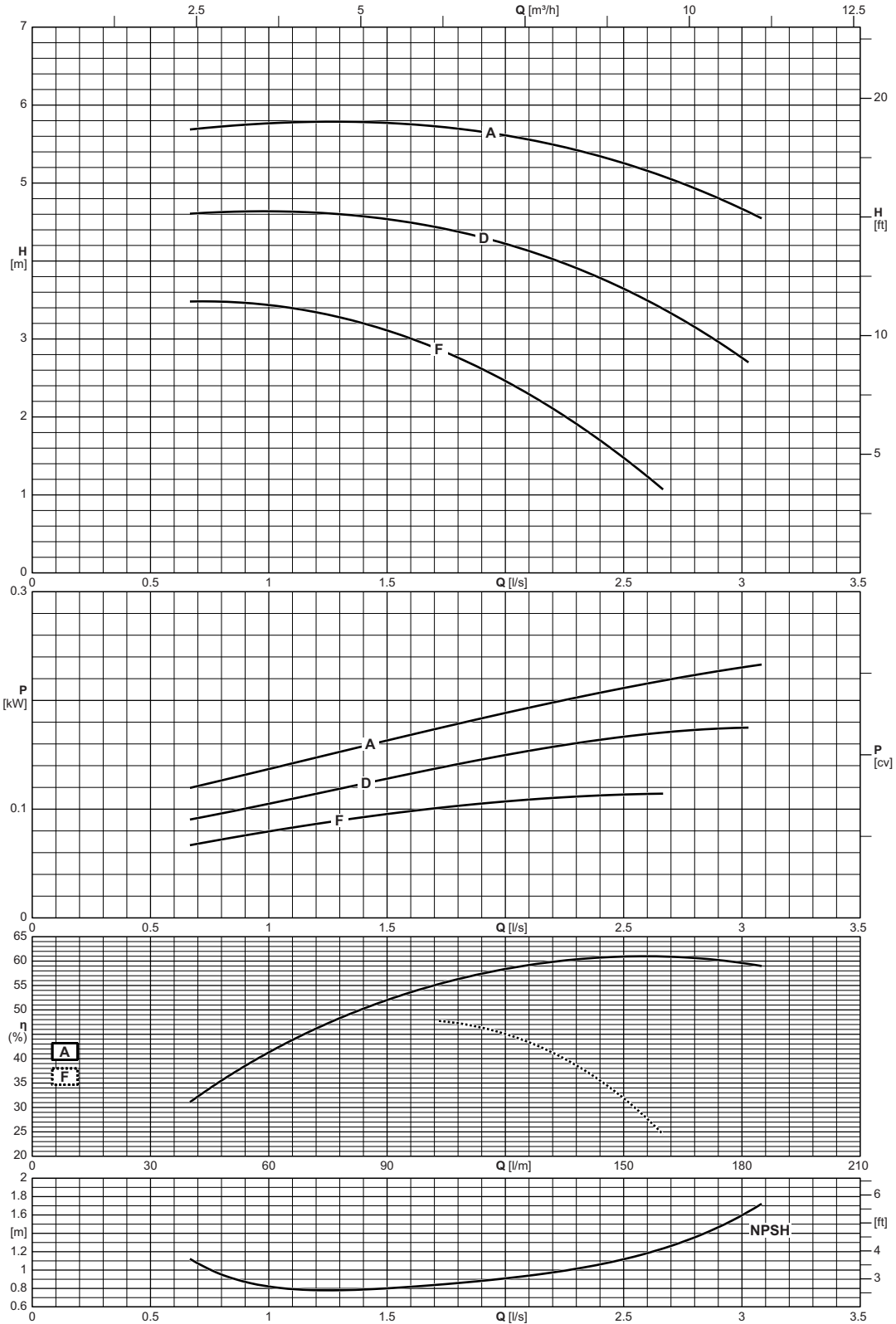

Type Type Tipo	Inlet maximum pressure Pression maximale en aspiration Pressione massima in aspirazione
NCD4P32-125	[bar] 10

NCD 4P32-160

1450 n [min⁻¹]



Operating data
 Caracteristiques de fonctionnement
 Caratteristiche di funzionamento

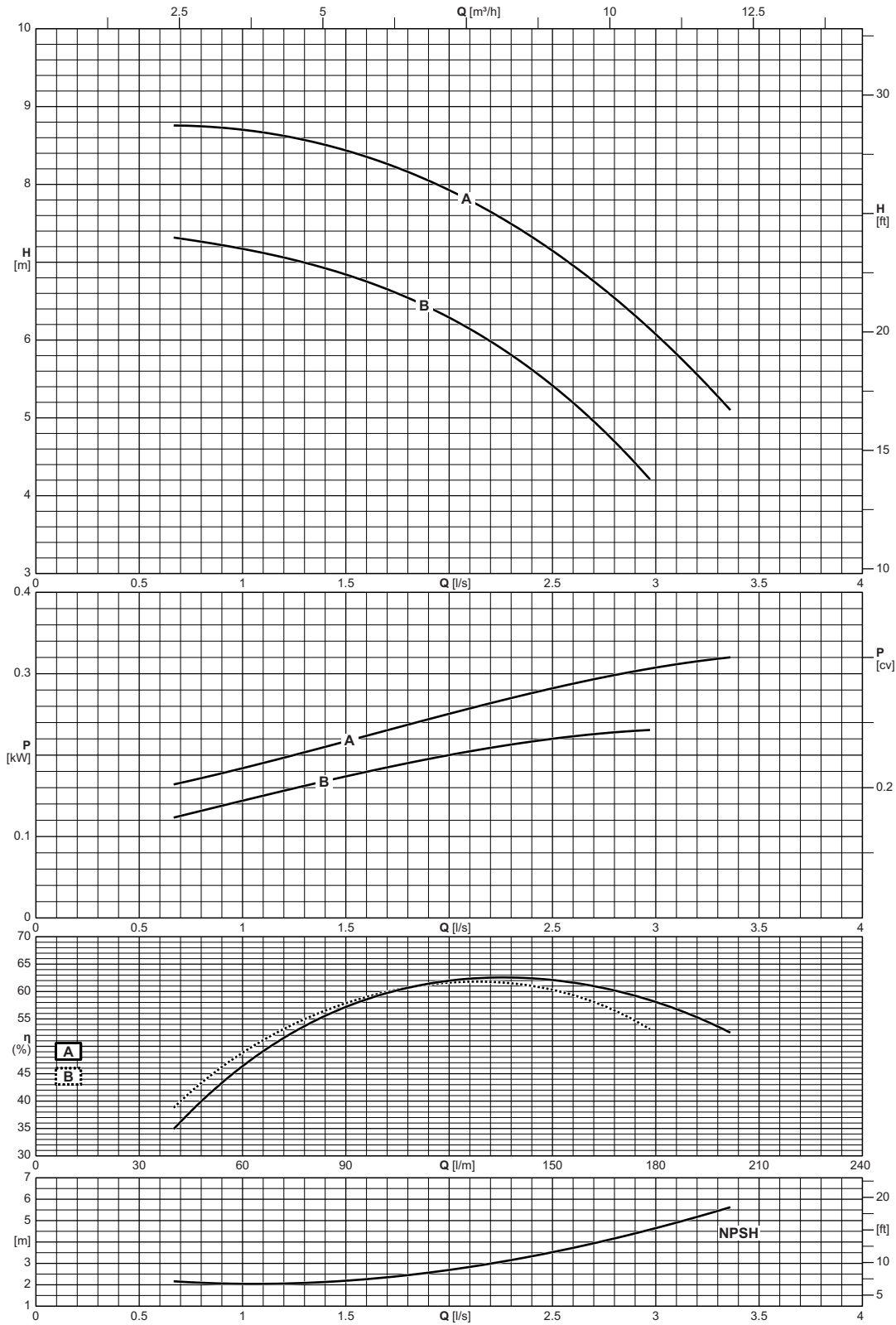

Type Type Tipo	Inlet maximum pressure Pression maximale en aspiration Pressione massima in aspirazione
NCD4P32-160	[bar] 10

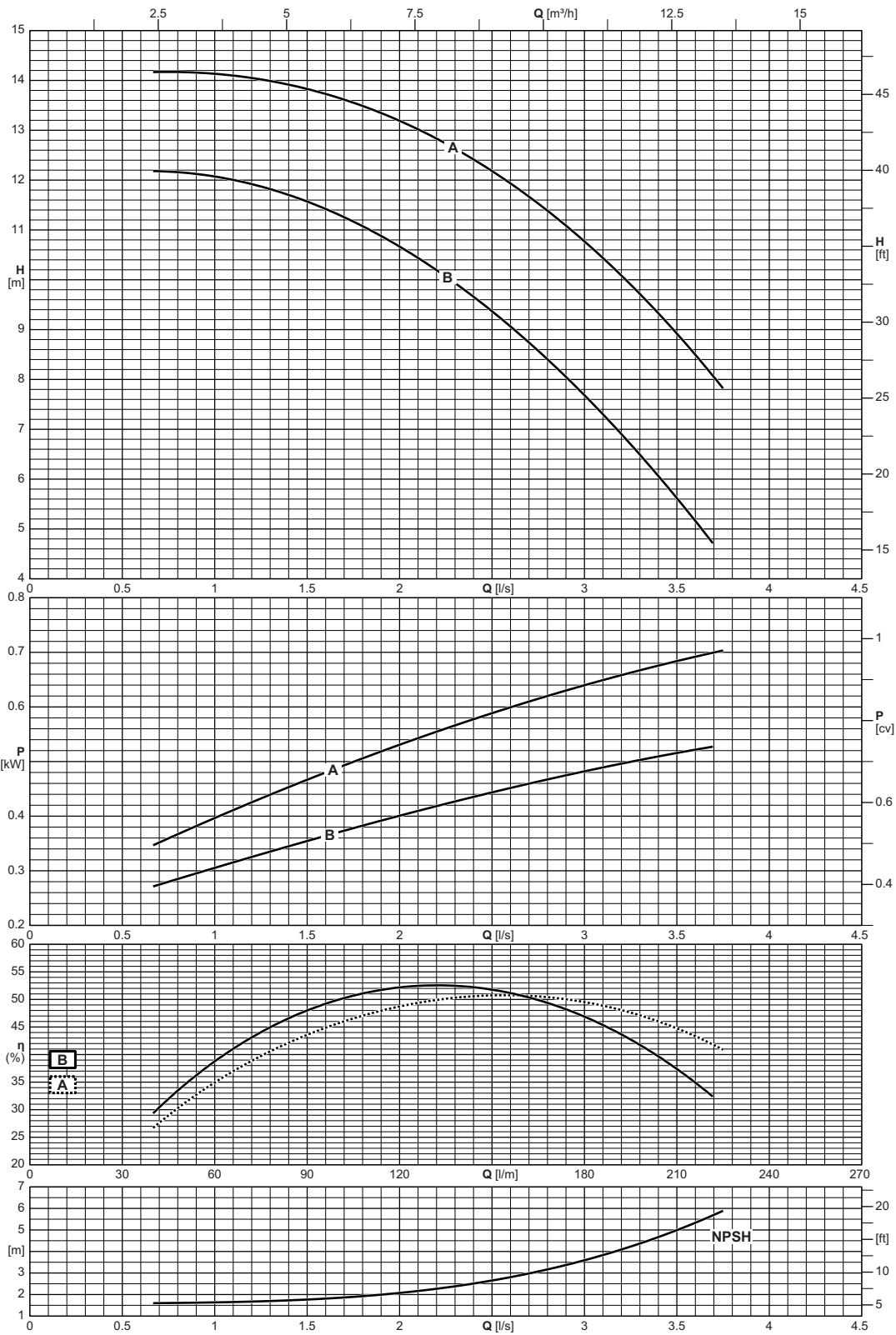

Type Type Tipo	Inlet maximum pressure Pression maximale en aspiration Pressione massima in aspirazione
NCD4P32-200	[bar] 10

NCD 4P40-160

1450 n [min⁻¹]



Operating data
 Caracteristiques de fonctionnement
 Caratteristiche di funzionamento

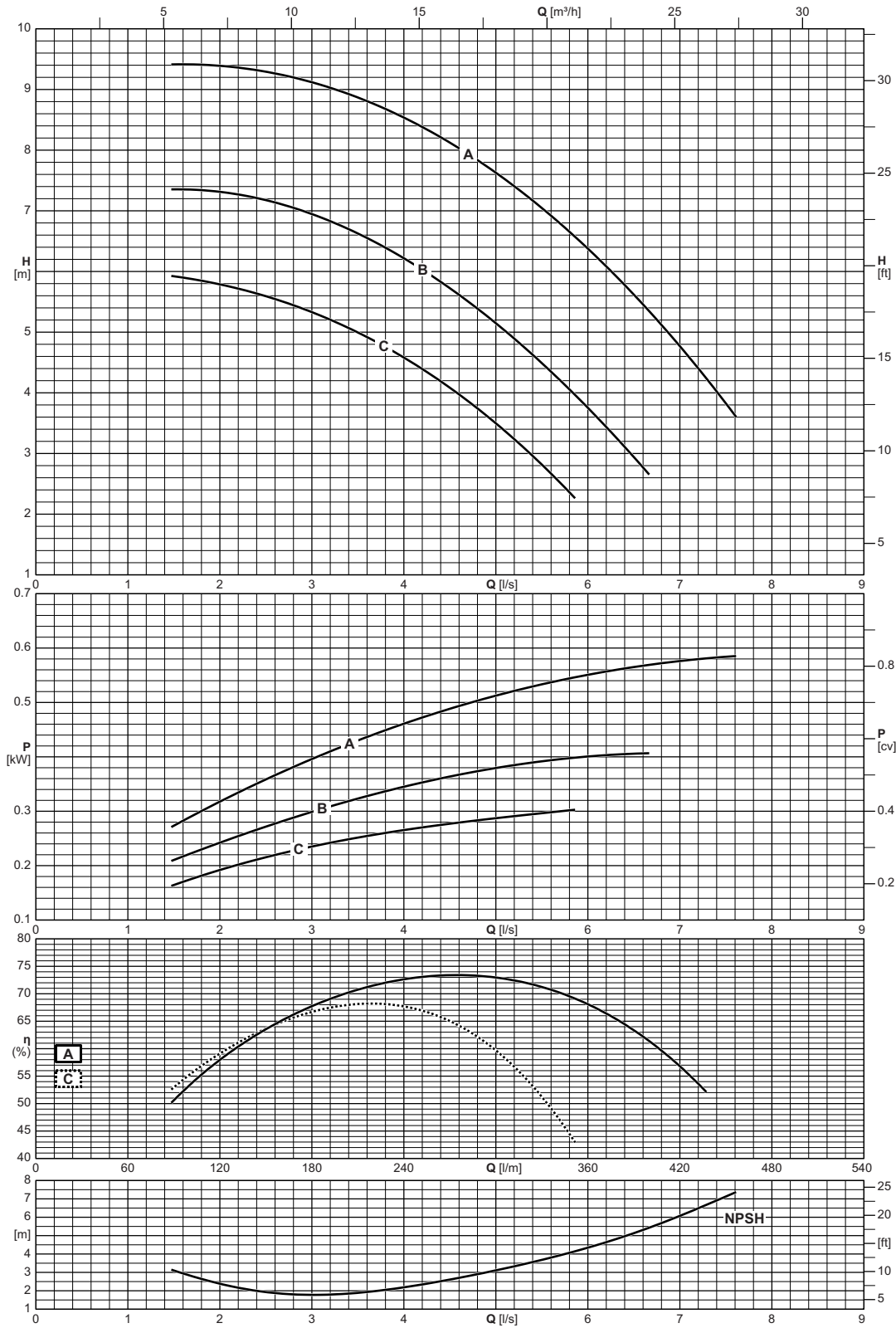

Type Type Tipo	Inlet maximum pressure Pression maximale en aspiration Pressione massima in aspirazione
NCD4P40-160	[bar] 10

Operating data
 Caracteristiques de fonctionnement
 Caratteristiche di funzionamento

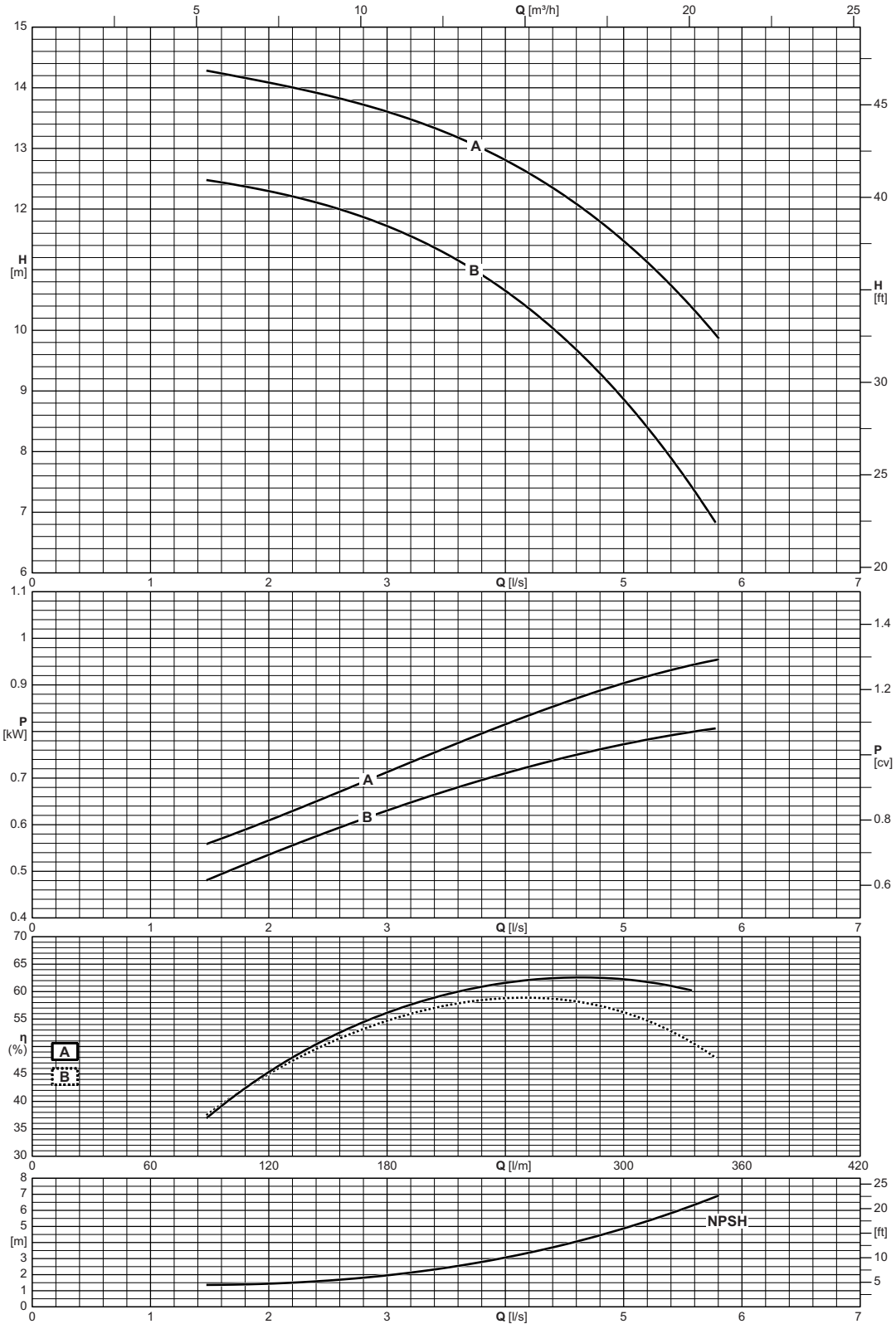

Type Type Tipo	Inlet maximum pressure Pression maximale en aspiration Pressione massima in aspirazione
NCD4P40-200	[bar] 10

NCD 4P40-250

1450 n [min⁻¹]



Operating data
Caracteristiques de fonctionnement
Caratteristiche di funzionamento

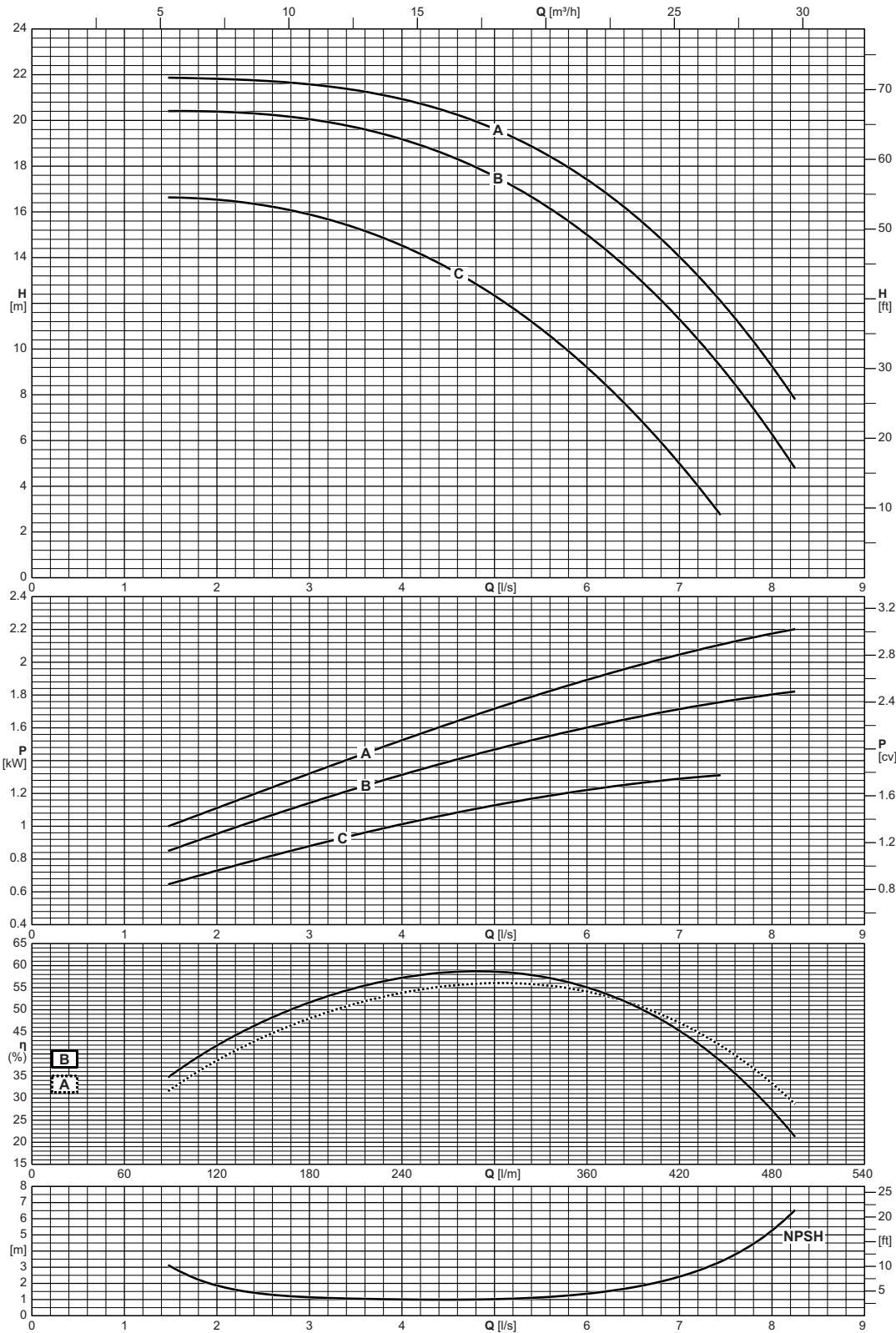

Type Type Tipo	Inlet maximum pressure Pression maximale en aspiration Pressione massima in aspirazione
NCD4P40-250	[bar] 10

Operating data
 Caracteristiques de fonctionnement
 Caratteristiche di funzionamento

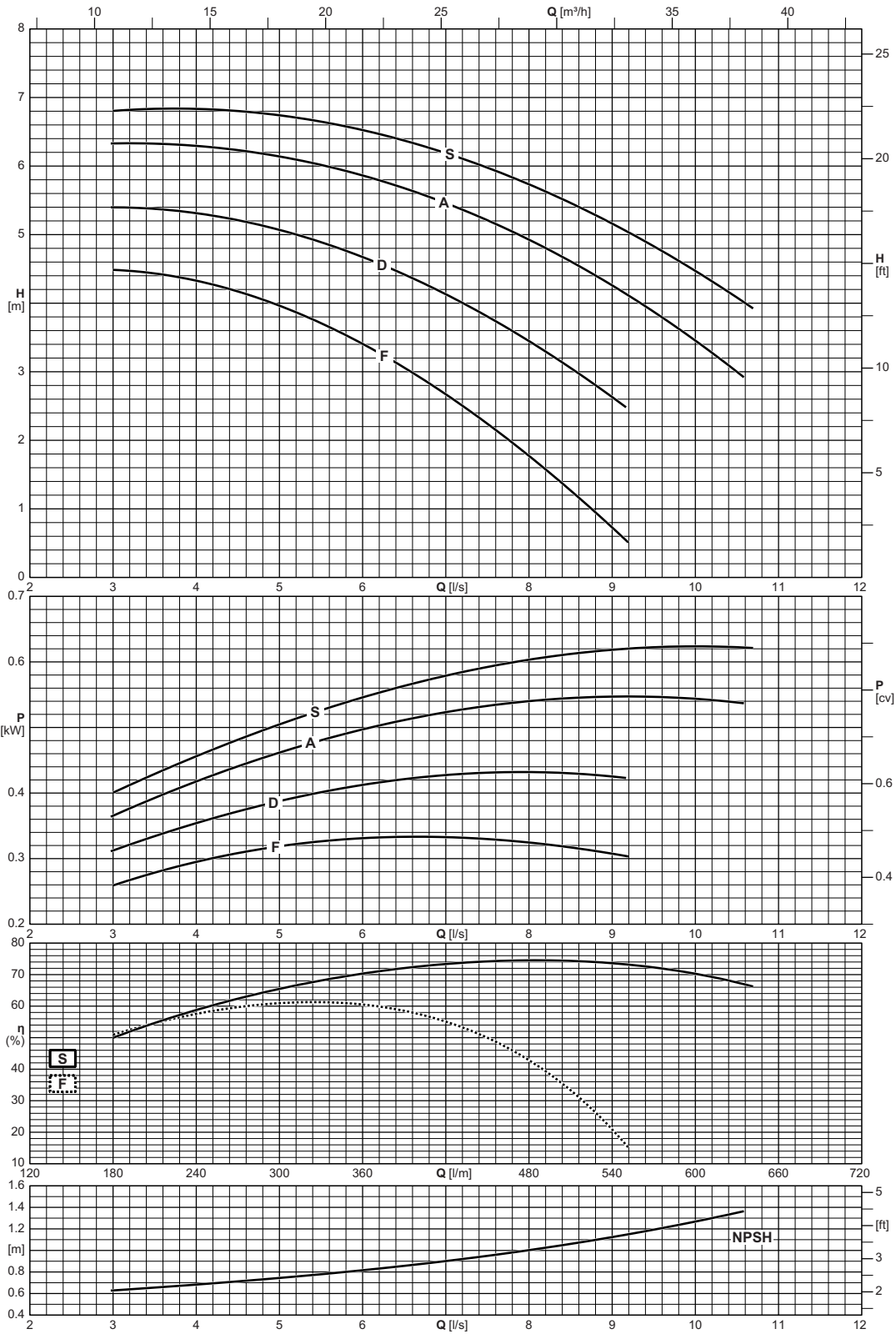

Type Type Tipo	Inlet maximum pressure Pression maximale en aspiration Pressione massima in aspirazione
NCD4P50-125	[bar] 10

NCD 4P50-160

1450 n [min⁻¹]



Operating data
Caracteristiques de fonctionnement
 Caratteristiche di funzionamento

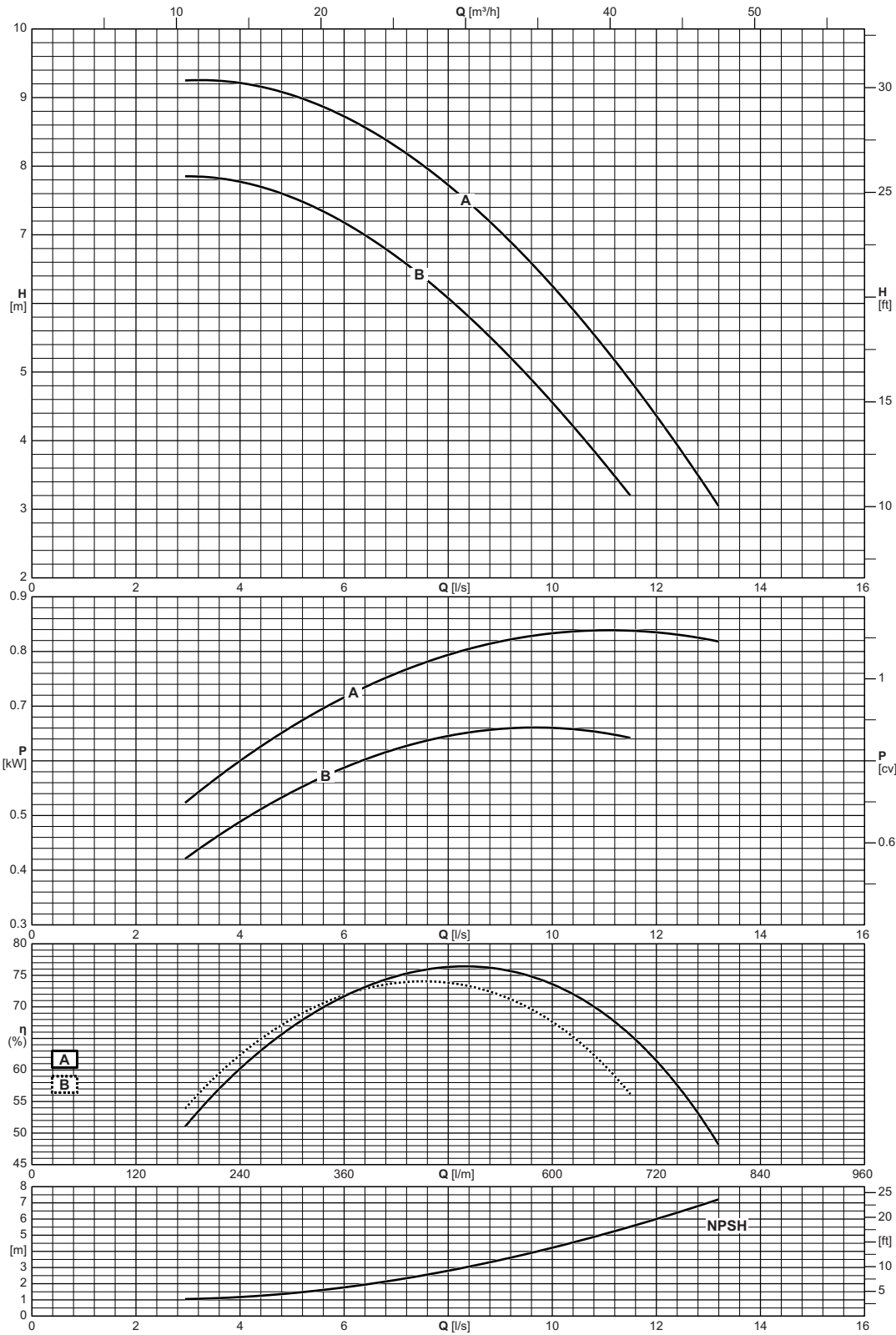

Type Type Tipo	Inlet maximum pressure Pression maximale en aspiration Pressione massima in aspirazione
NCD4P50-160	[bar] 10

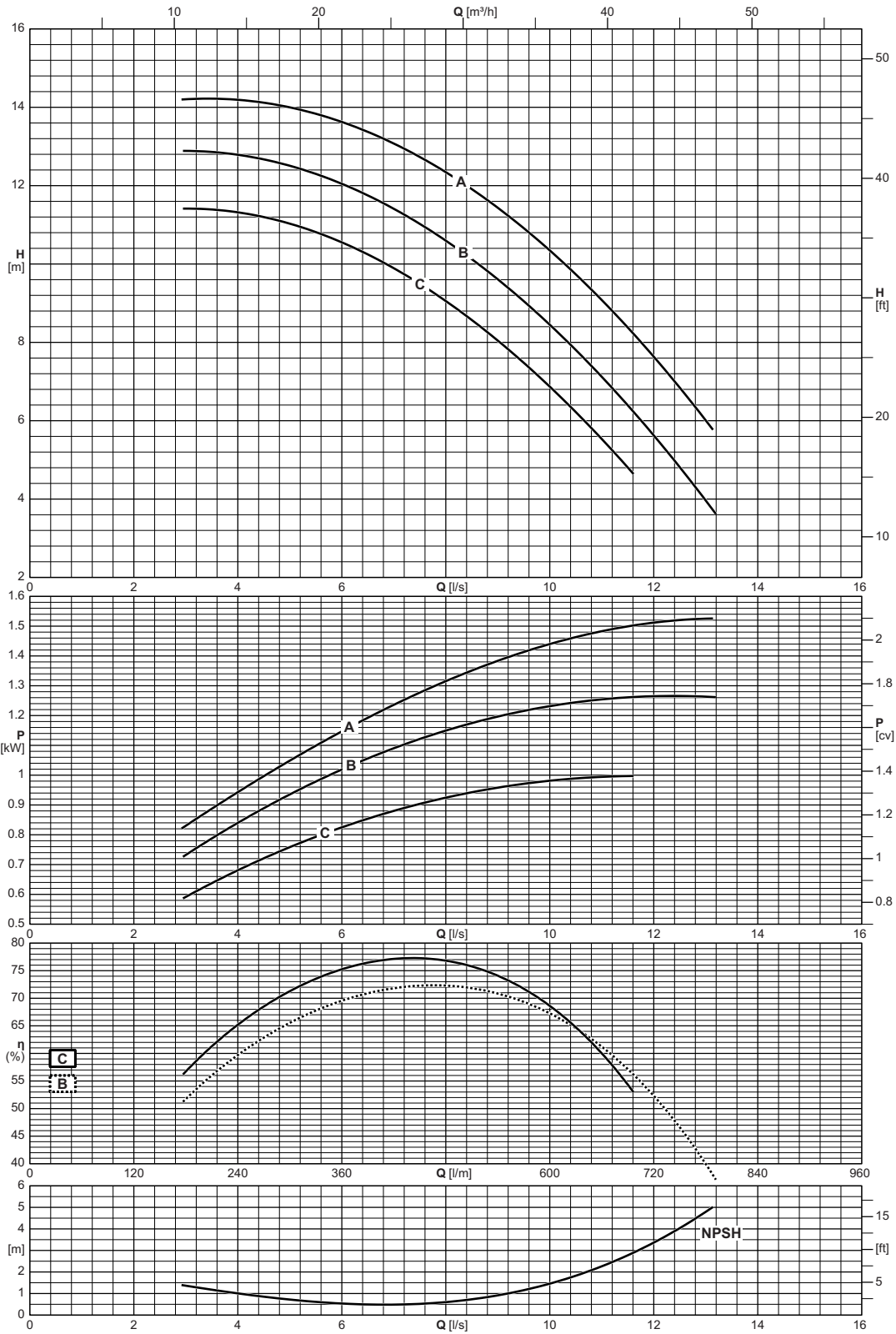

Type Type Tipo	Inlet maximum pressure Pression maximale en aspiration Pressione massima in aspirazione
NCD4P50-200	[bar] 10

NCD 4P50-250

1450 n [min⁻¹]



Operating data
Caracteristiques de fonctionnement
Caratteristiche di funzionamento

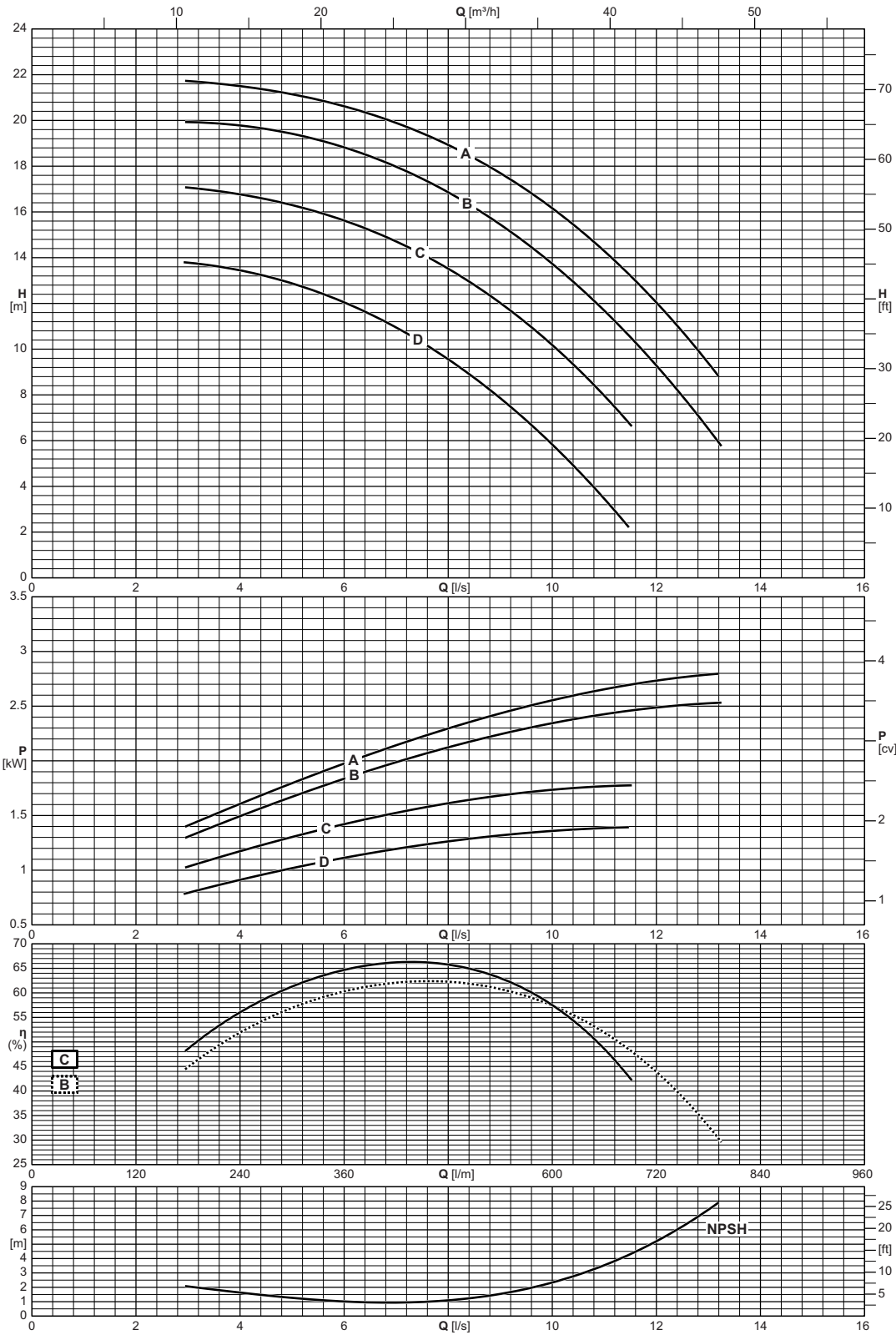

Type Type Tipo	Inlet maximum pressure Pression maximale en aspiration Pressione massima in aspirazione
NCD4P50-250	[bar] 10

Operating data
 Caracteristiques de fonctionnement
 Caratteristiche di funzionamento

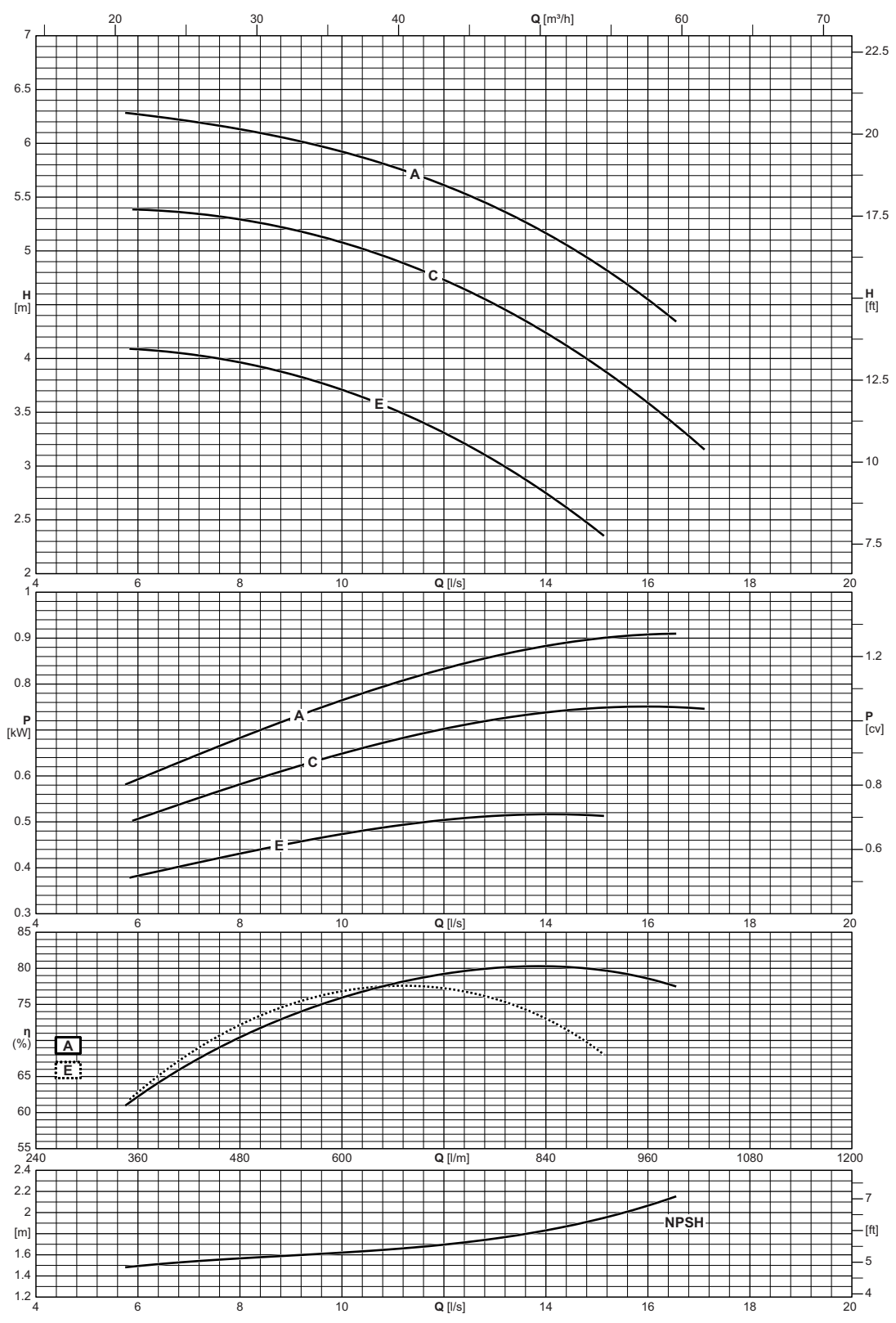

Type Type Tipo	Inlet maximum pressure Pression maximale en aspiration Pressione massima in aspirazione
NCD4P65-125	[bar] 10

NCD 4P65-160

1450 n [min⁻¹]



Operating data
Caracteristiques de fonctionnement
Caratteristiche di funzionamento

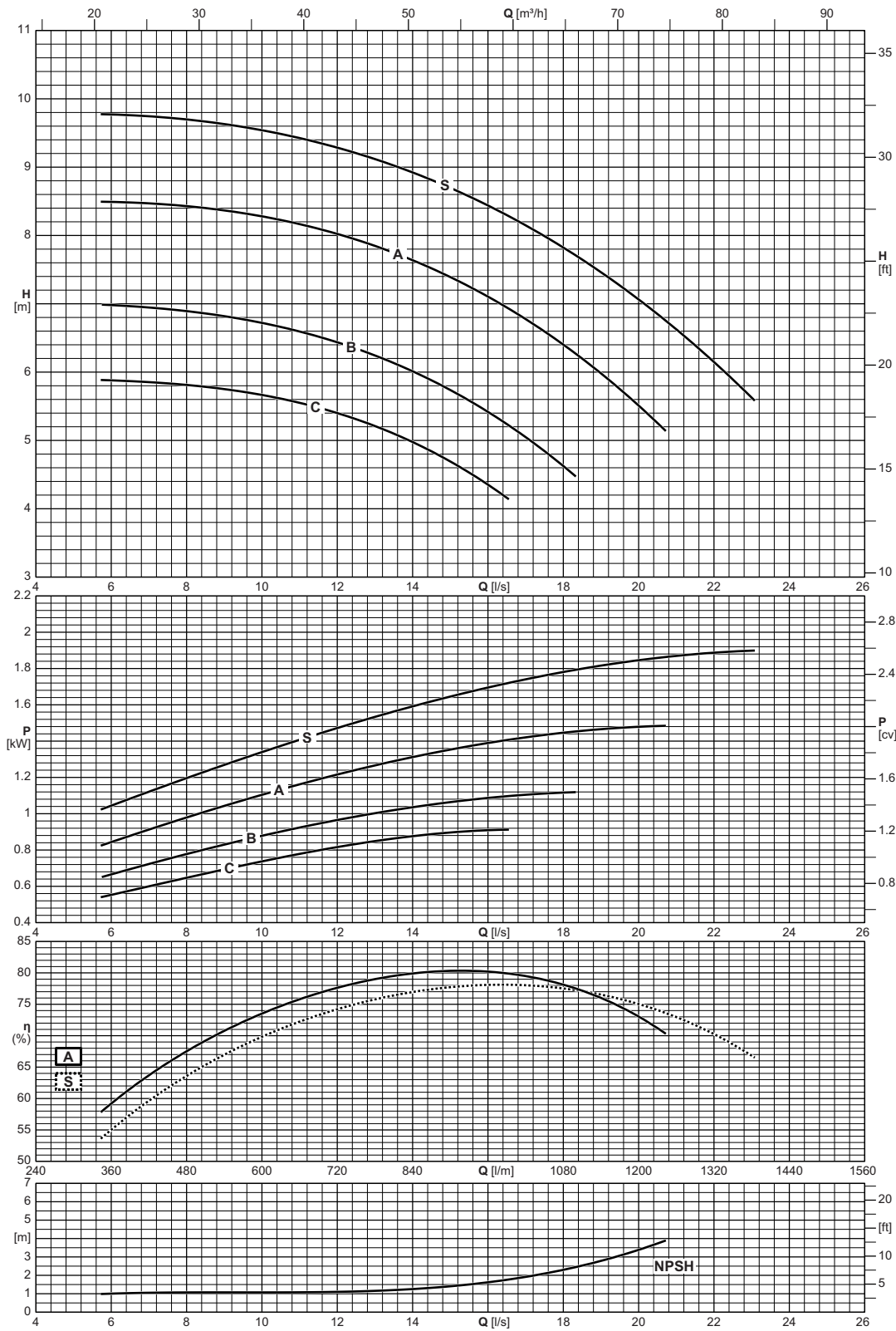

Type Type Tipo	Inlet maximum pressure Pression maximale en aspiration Pressione massima in aspirazione
NCD4P65-160	[bar] 10

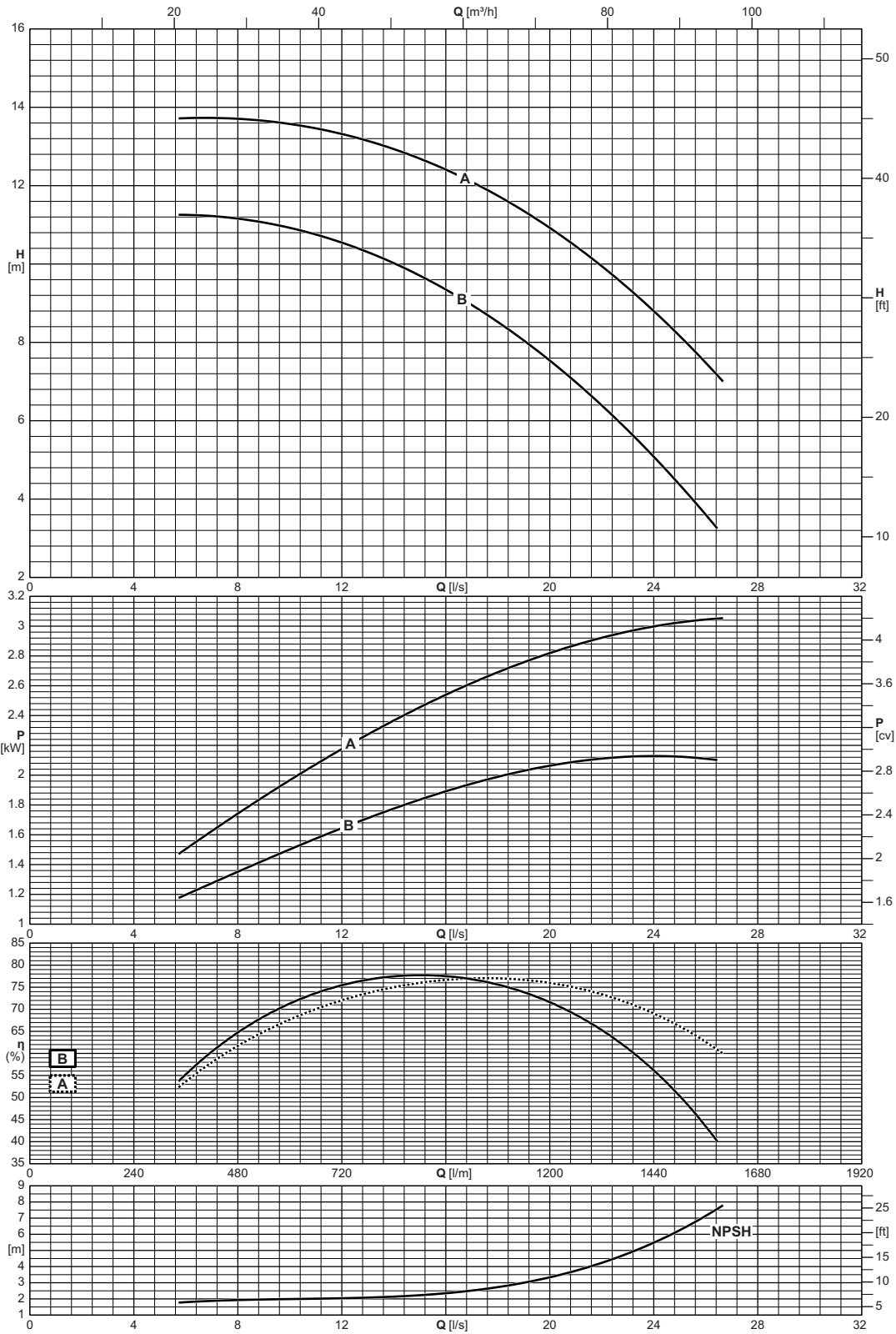

Type Type Tipo	Inlet maximum pressure Pression maximale en aspiration Pressione massima in aspirazione
NCD4P65-200	[bar] 10

NCD 4P65-250

1450 n [min⁻¹]



Operating data
Caracteristiques de fonctionnement
 Caratteristiche di funzionamento

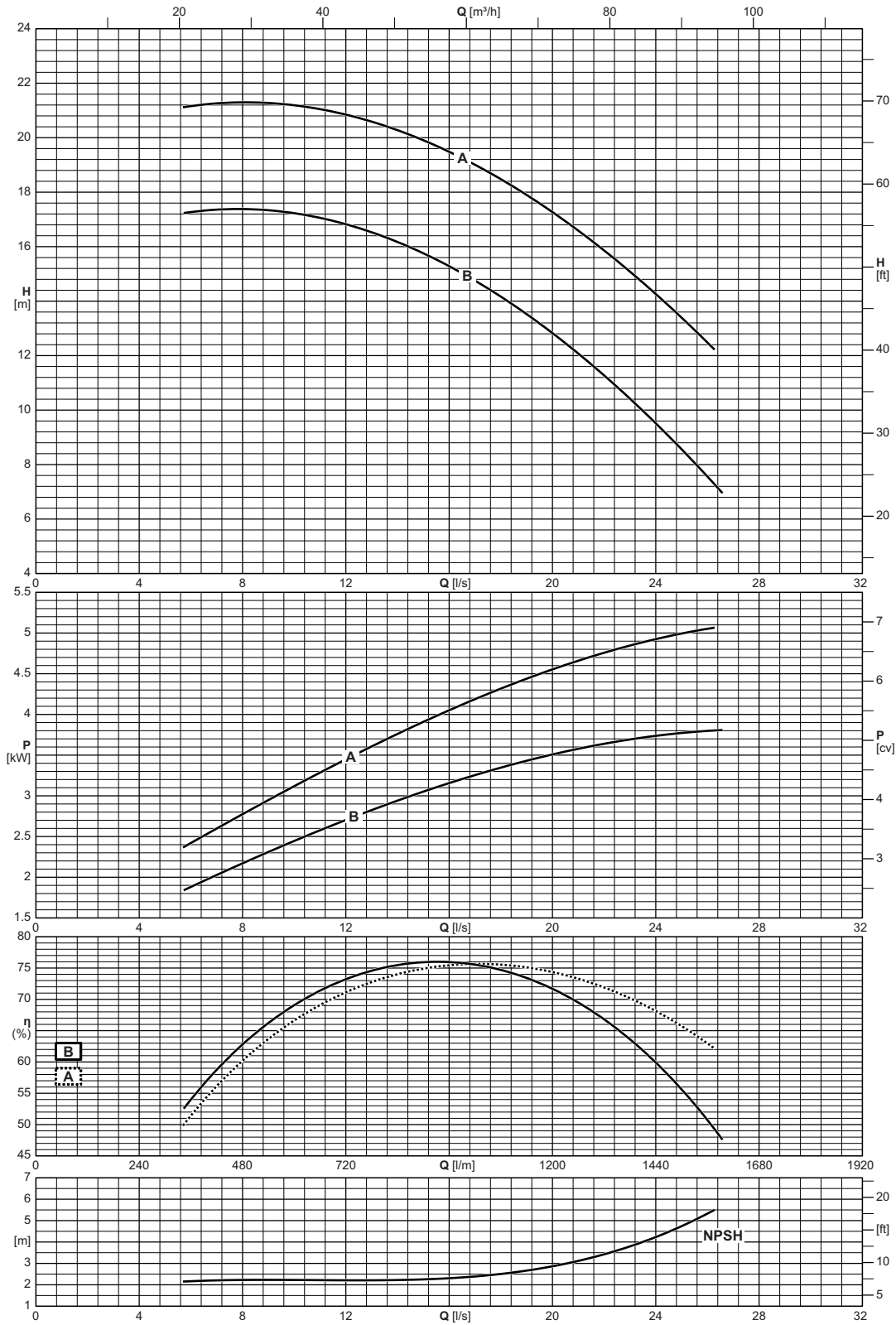

Type Type Tipo	Inlet maximum pressure Pression maximale en aspiration Pressione massima in aspirazione
NCD4P65-250	[bar] 10

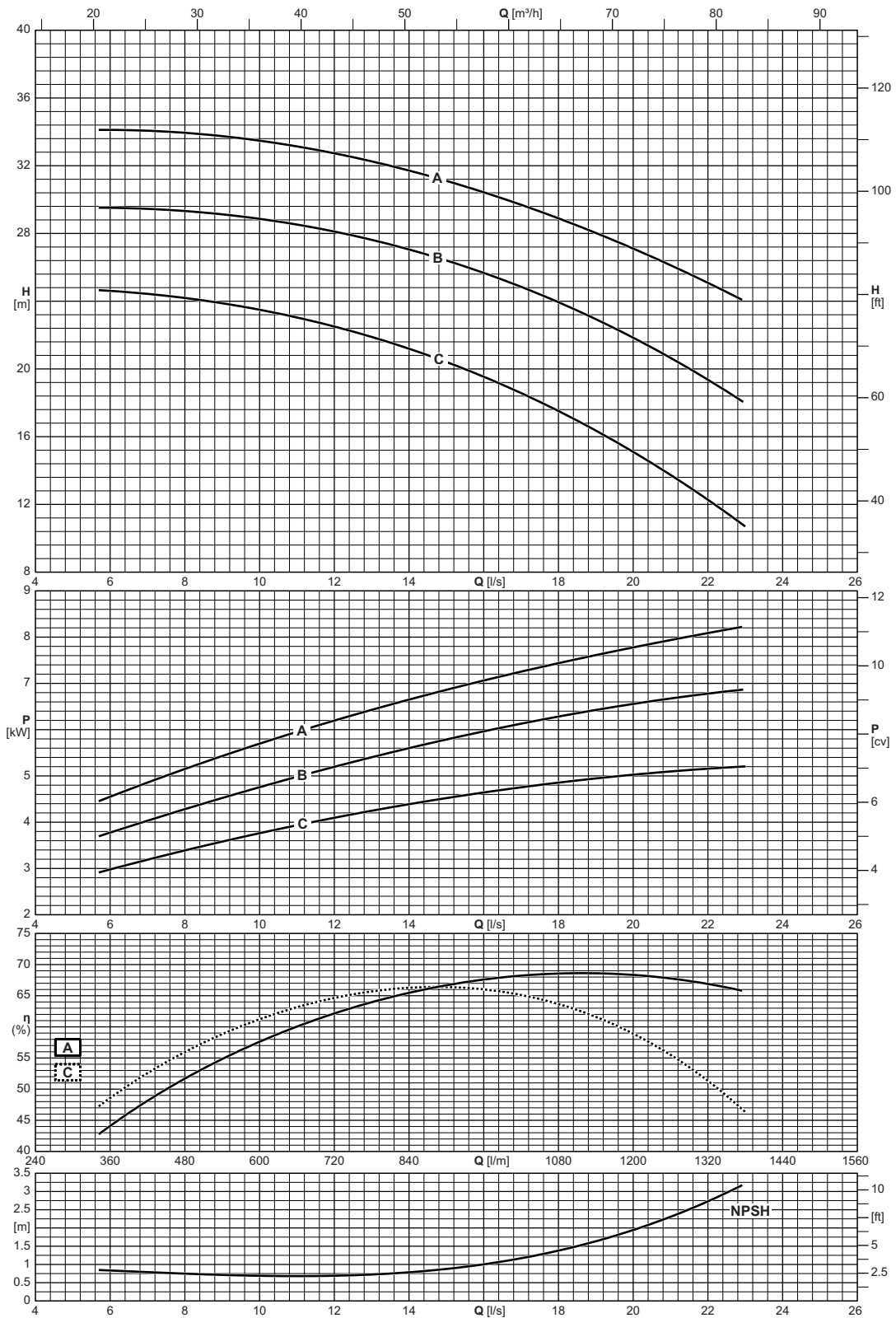

Type Type Tipo	Inlet maximum pressure Pression maximale en aspiration Pressione massima in aspirazione
NCD4P65-315	[bar] 10

NCD 4P80-160

1450 n [min⁻¹]



Operating data
 Caracteristiques de fonctionnement
 Caratteristiche di funzionamento

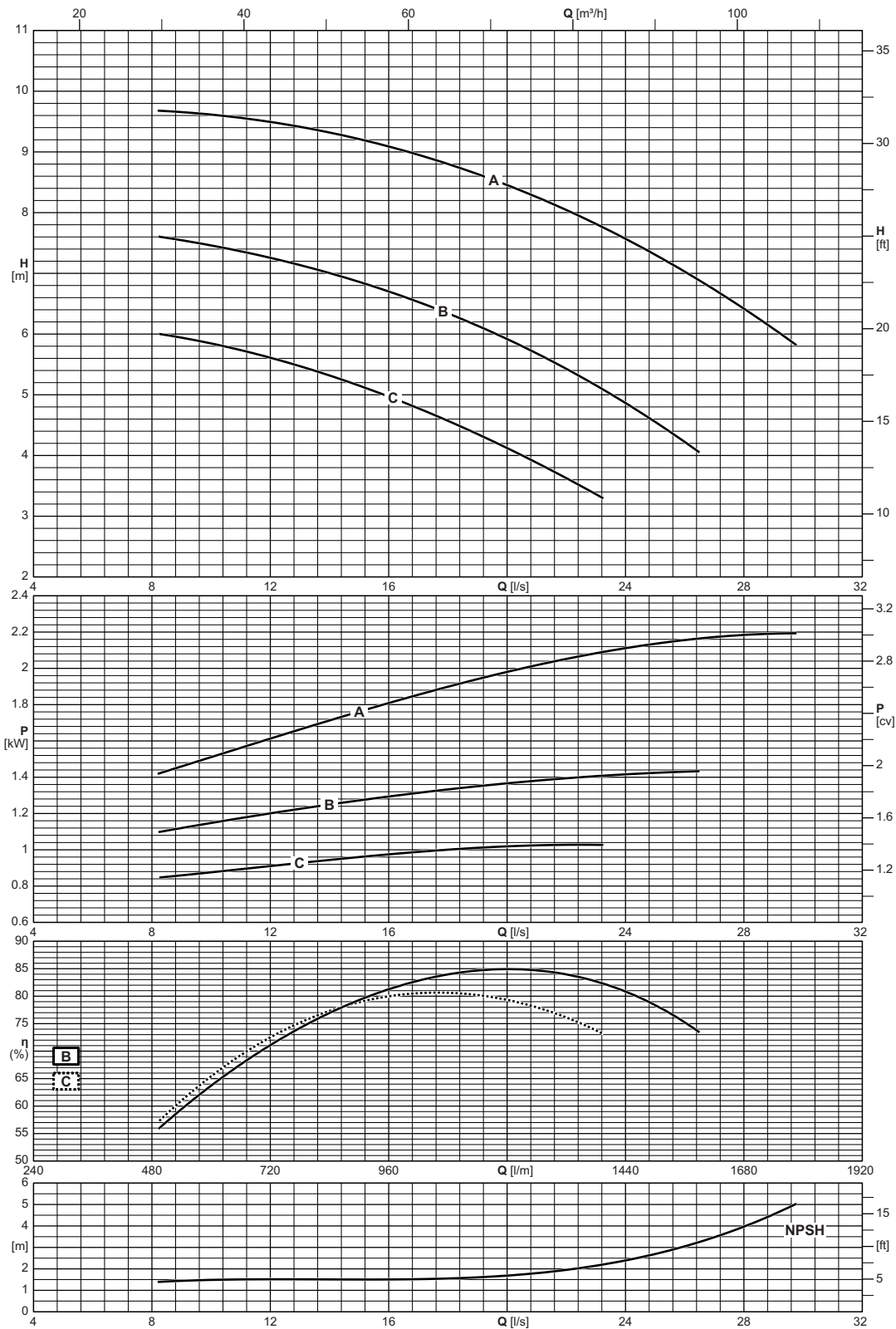

Type Type Tipo	Inlet maximum pressure Pression maximale en aspiration Pressione massima in aspirazione
NCD4P80-160	[bar] 10

Operating data
 Caracteristiques de fonctionnement
 Caratteristiche di funzionamento

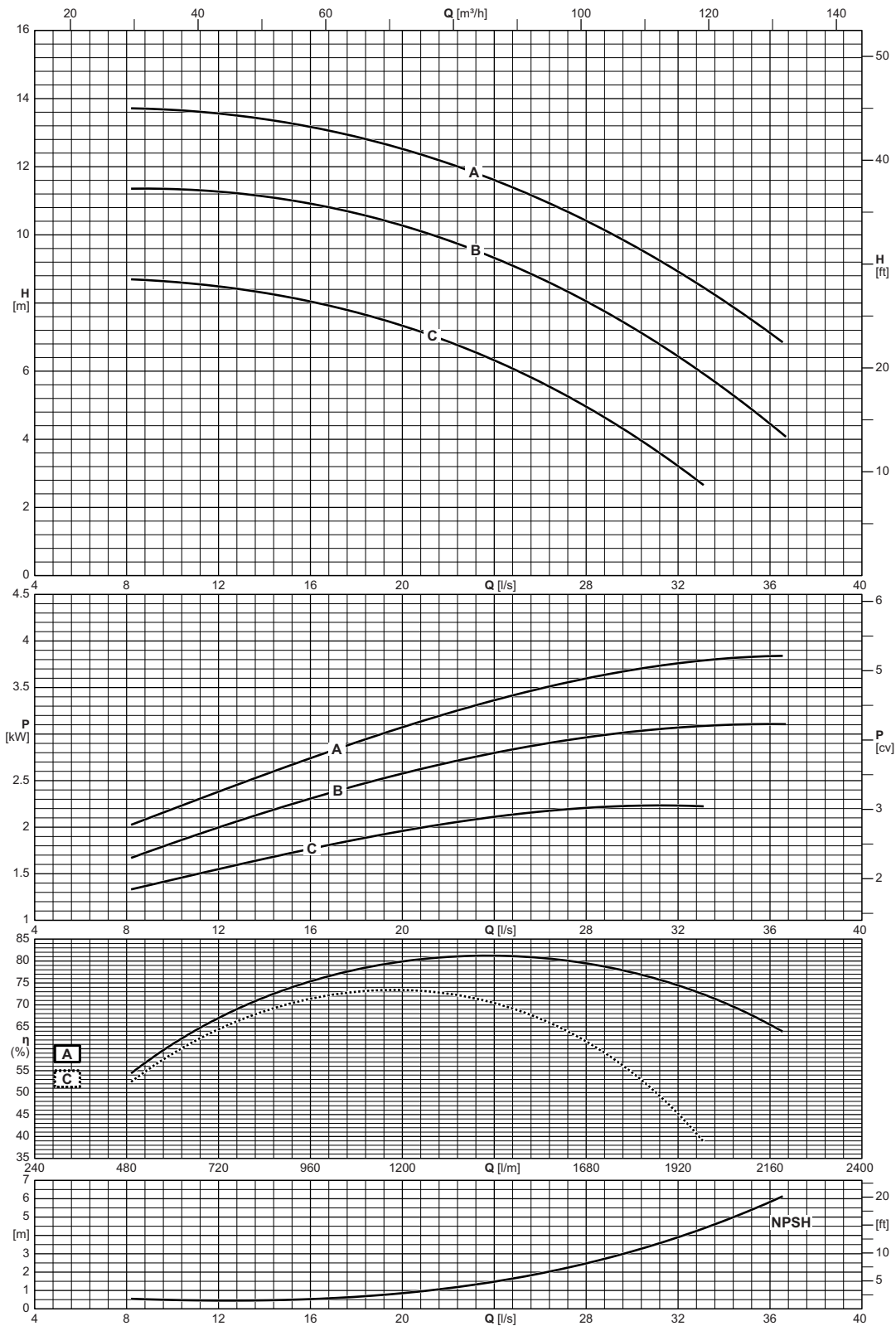

Type Type Tipo	Inlet maximum pressure Pression maximale en aspiration Pressione massima in aspirazione
NCD4P80-200	[bar] 10

NCD 4P80-250

1450 n [min⁻¹]



Operating data
Caracteristiques de fonctionnement
Caratteristiche di funzionamento

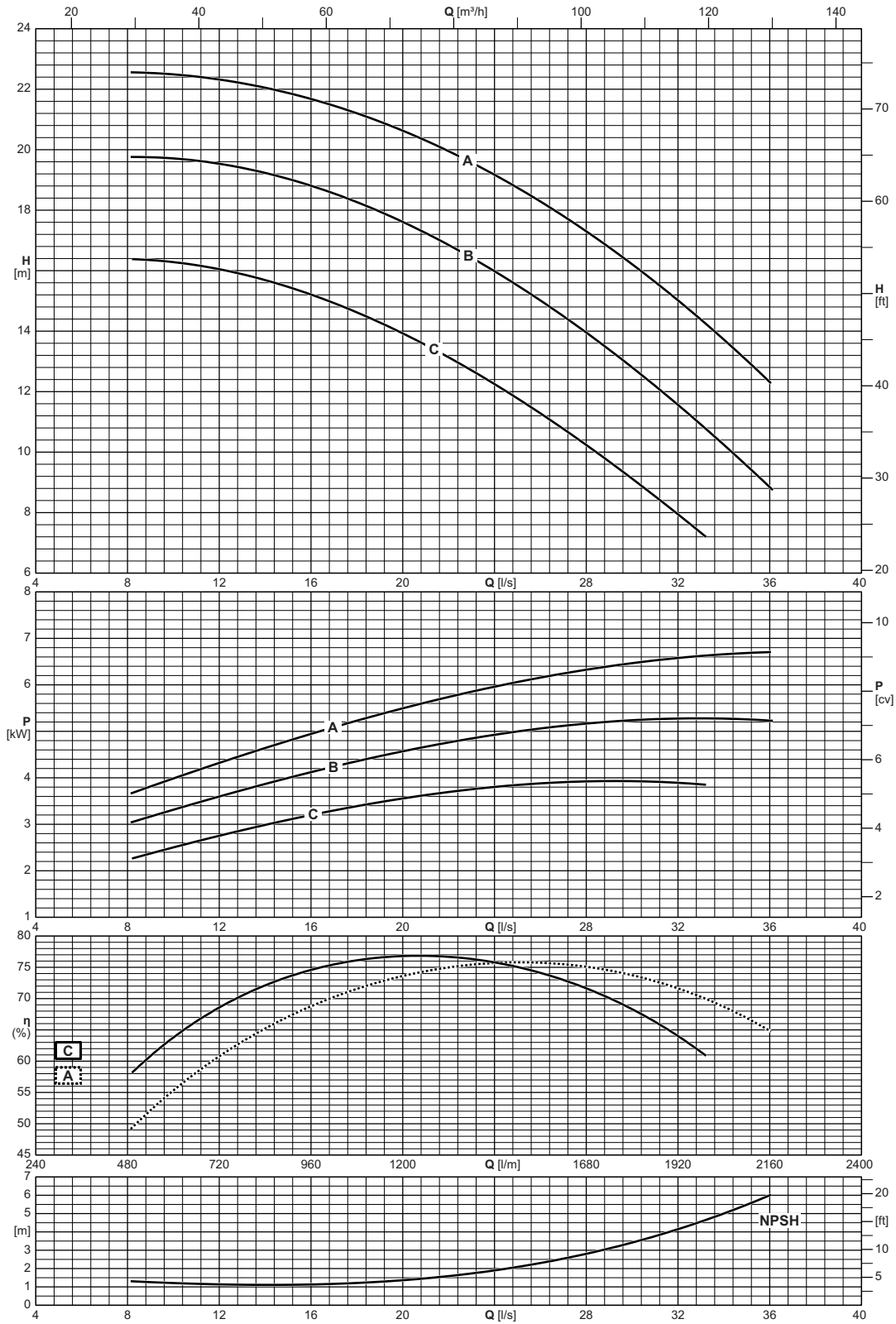

Type Type Tipo	Inlet maximum pressure Pression maximale en aspiration Pressione massima in aspirazione
NCD4P80-250	[bar] 10

Operating data
 Caracteristiques de fonctionnement
 Caratteristiche di funzionamento

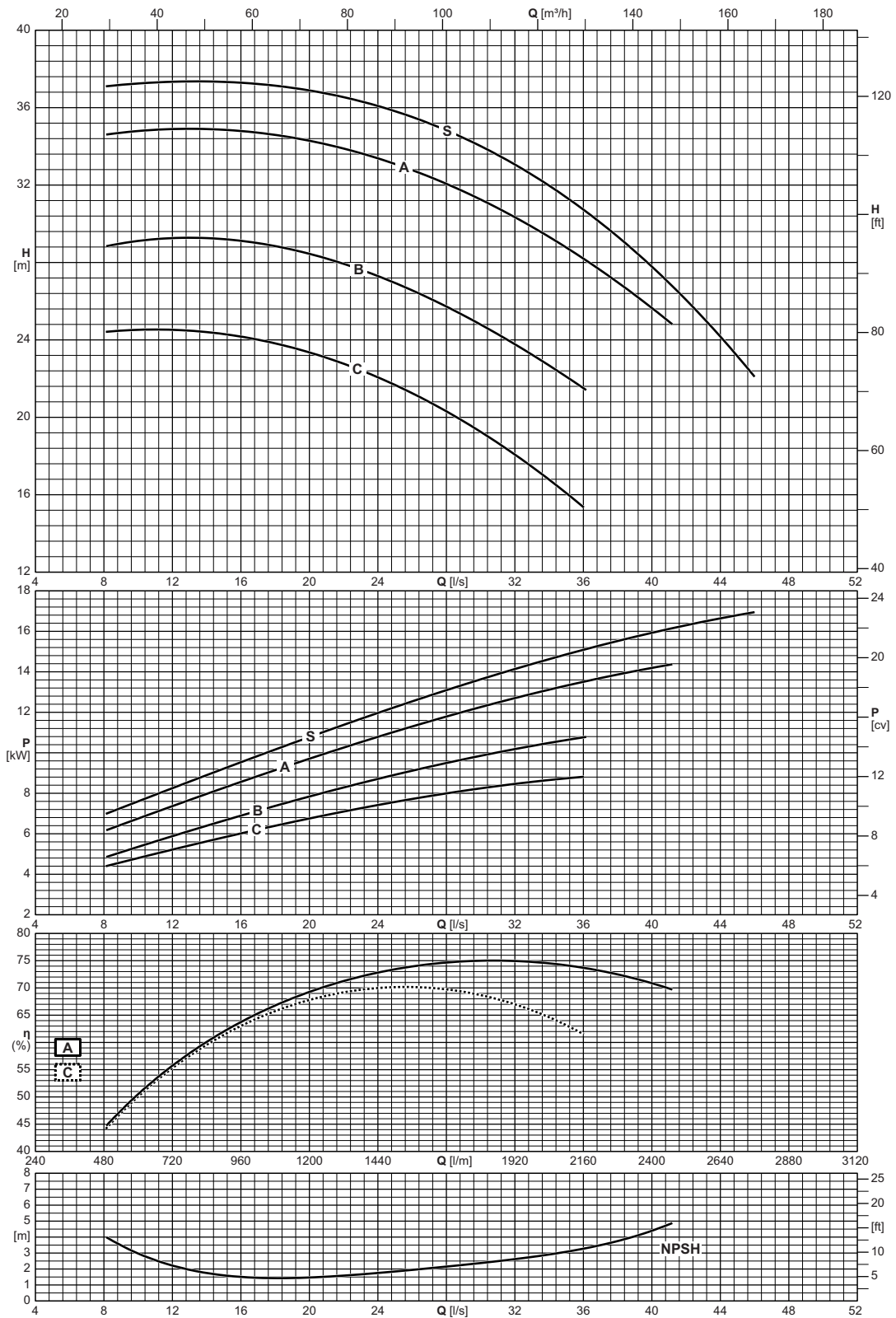

Type Type Tipo	Inlet maximum pressure Pression maximale en aspiration Pressione massima in aspirazione
NCD4P80-315	[bar] 10

NCD 4P80-400

1450 n [min⁻¹]



Operating data
 Caracteristiques de fonctionnement
 Caratteristiche di funzionamento

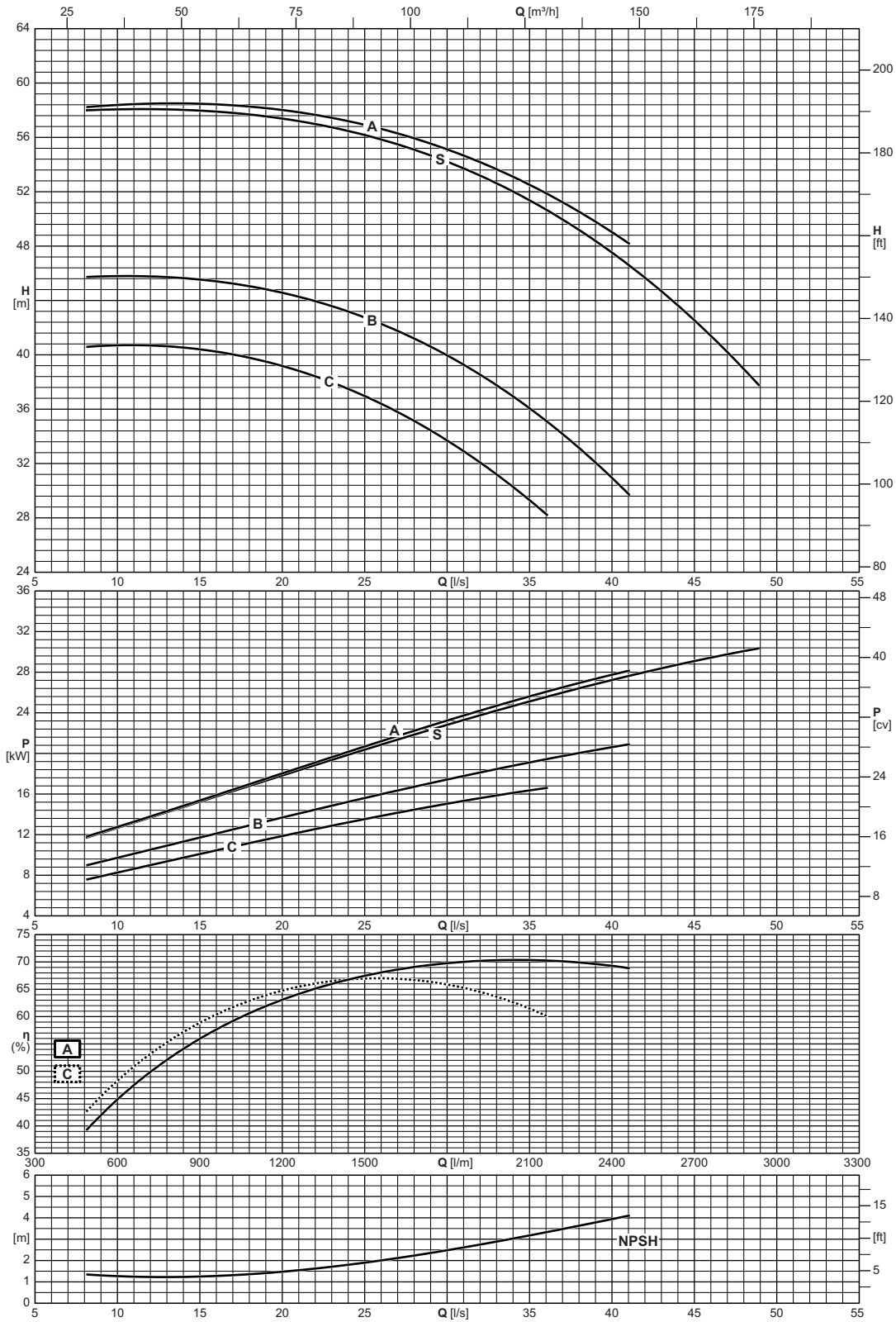

Type Type Tipo	Inlet maximum pressure Pression maximale en aspiration Pressione massima in aspirazione
NCD4P80-400	[bar] 10

Operating data
 Caracteristiques de fonctionnement
 Caratteristiche di funzionamento

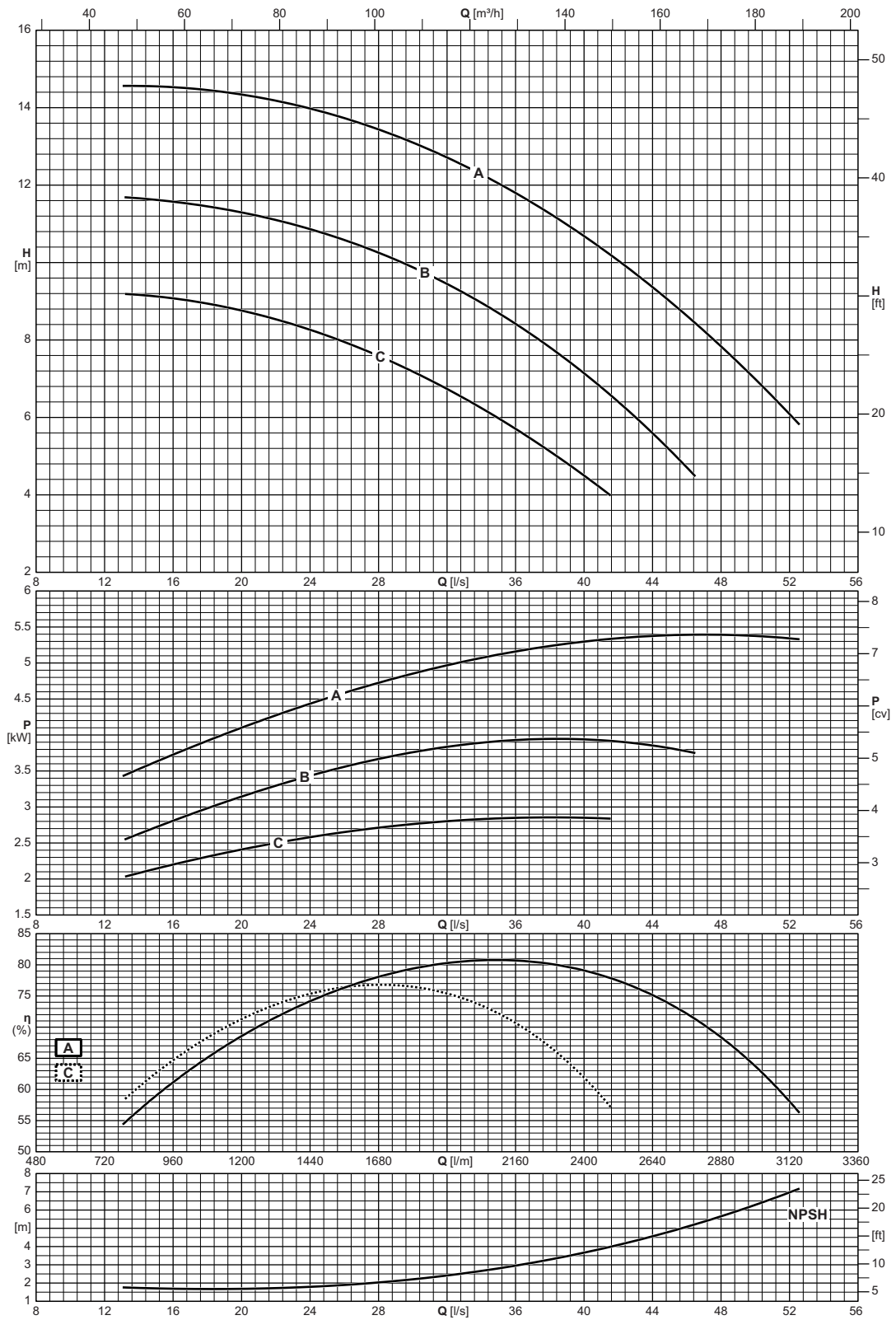

Type Type Tipo	Inlet maximum pressure Pression maximale en aspiration Pressione massima in aspirazione
NCD4P100-200	[bar] 10

NCD 4P100-250

1450 n [min⁻¹]



Operating data
 Caracteristiques de fonctionnement
 Caratteristiche di funzionamento

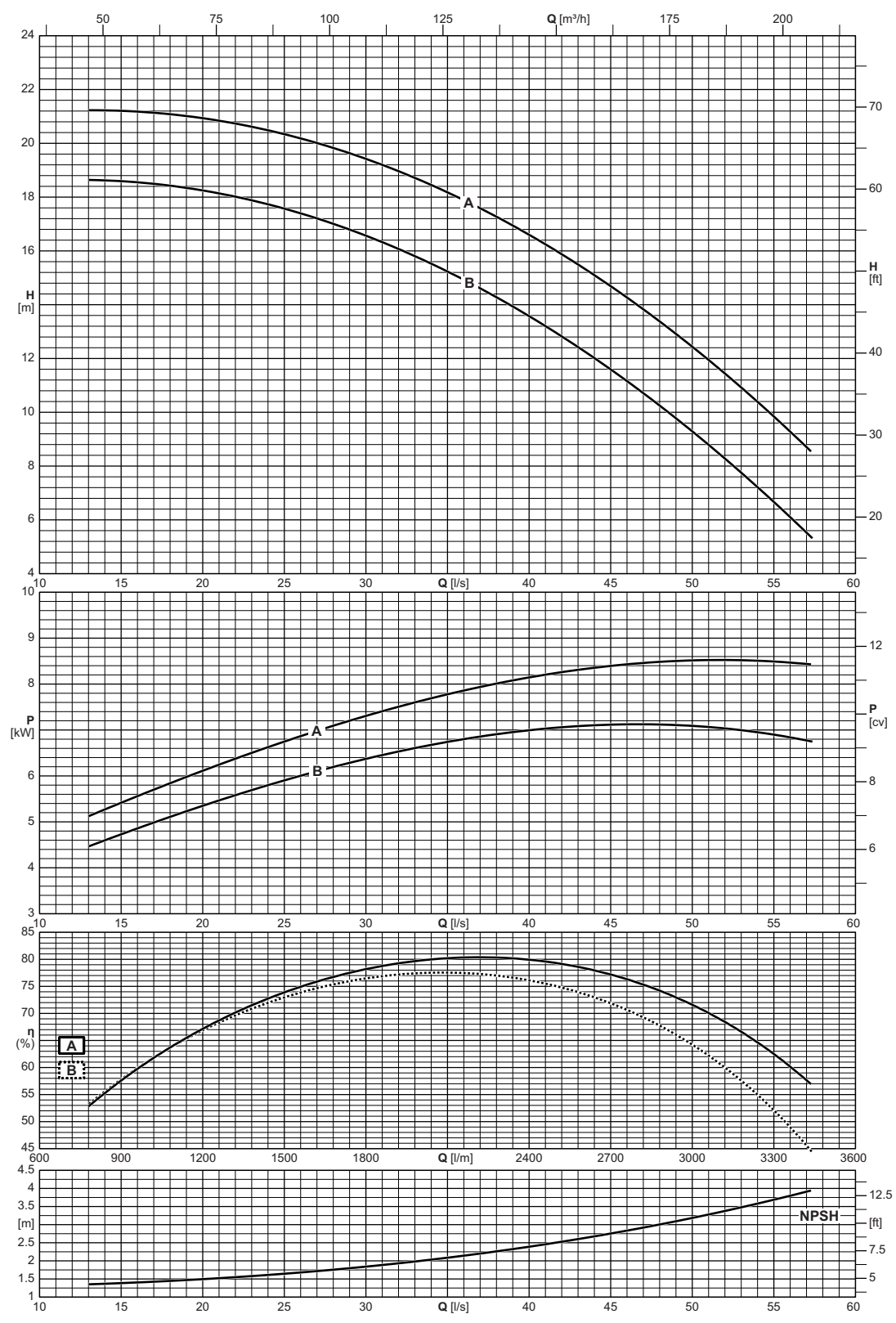

Type Type Tipo	Inlet maximum pressure Pression maximale en aspiration Pressione massima in aspirazione
NCD4P100-250	[bar] 10

Cod. 998911/10-23 - Copyright © 2006 Caprari S.p.A. - All Rights Reserved

Operating data
 Caracteristiques de fonctionnement
 Caratteristiche di funzionamento

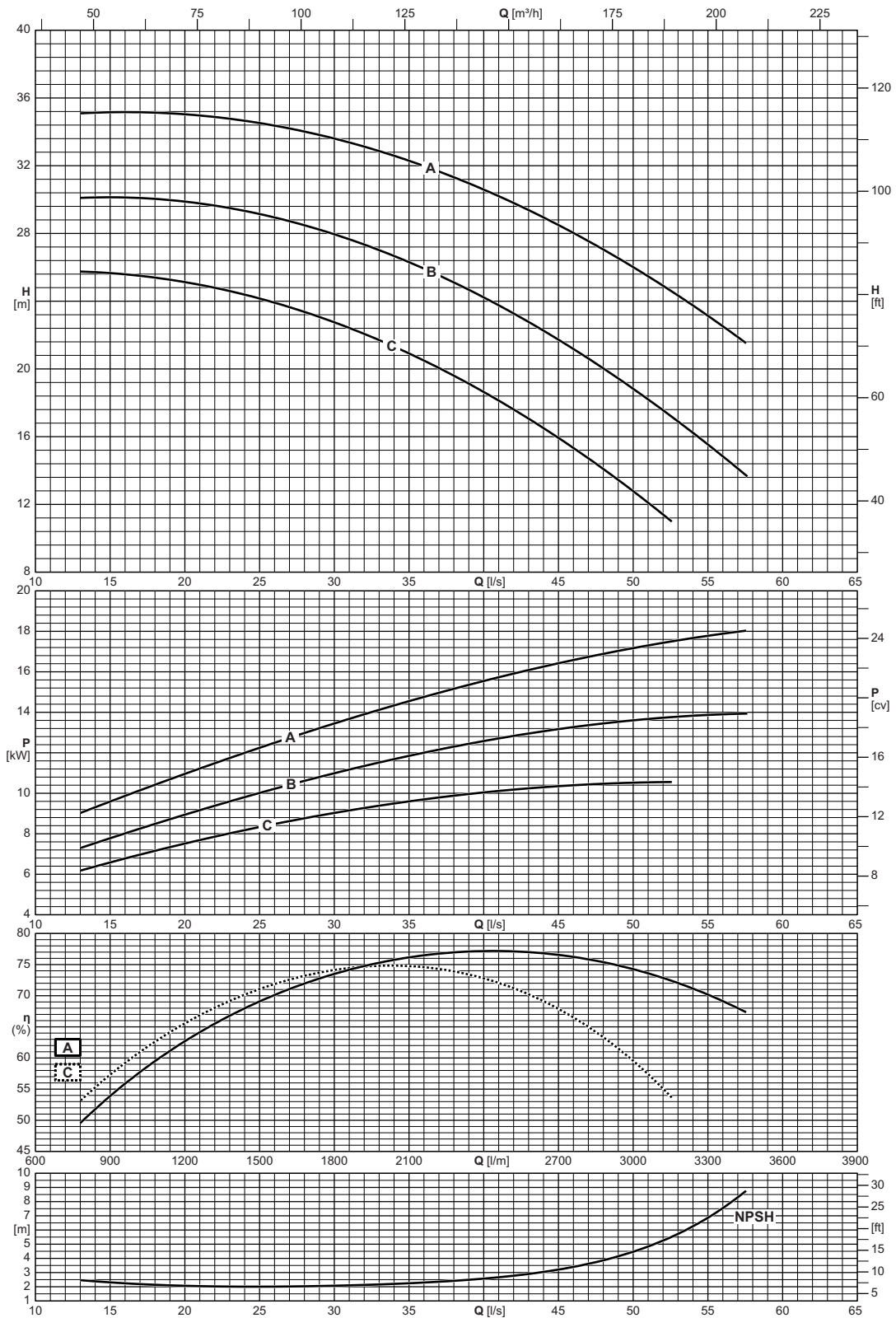

Type Type Tipo	Inlet maximum pressure Pression maximale en aspiration Pressione massima in aspirazione
NCD4P100-315	[bar] 10

NCD 4P100-400

1450 n [min⁻¹]



Operating data
Caracteristiques de fonctionnement
Caratteristiche di funzionamento

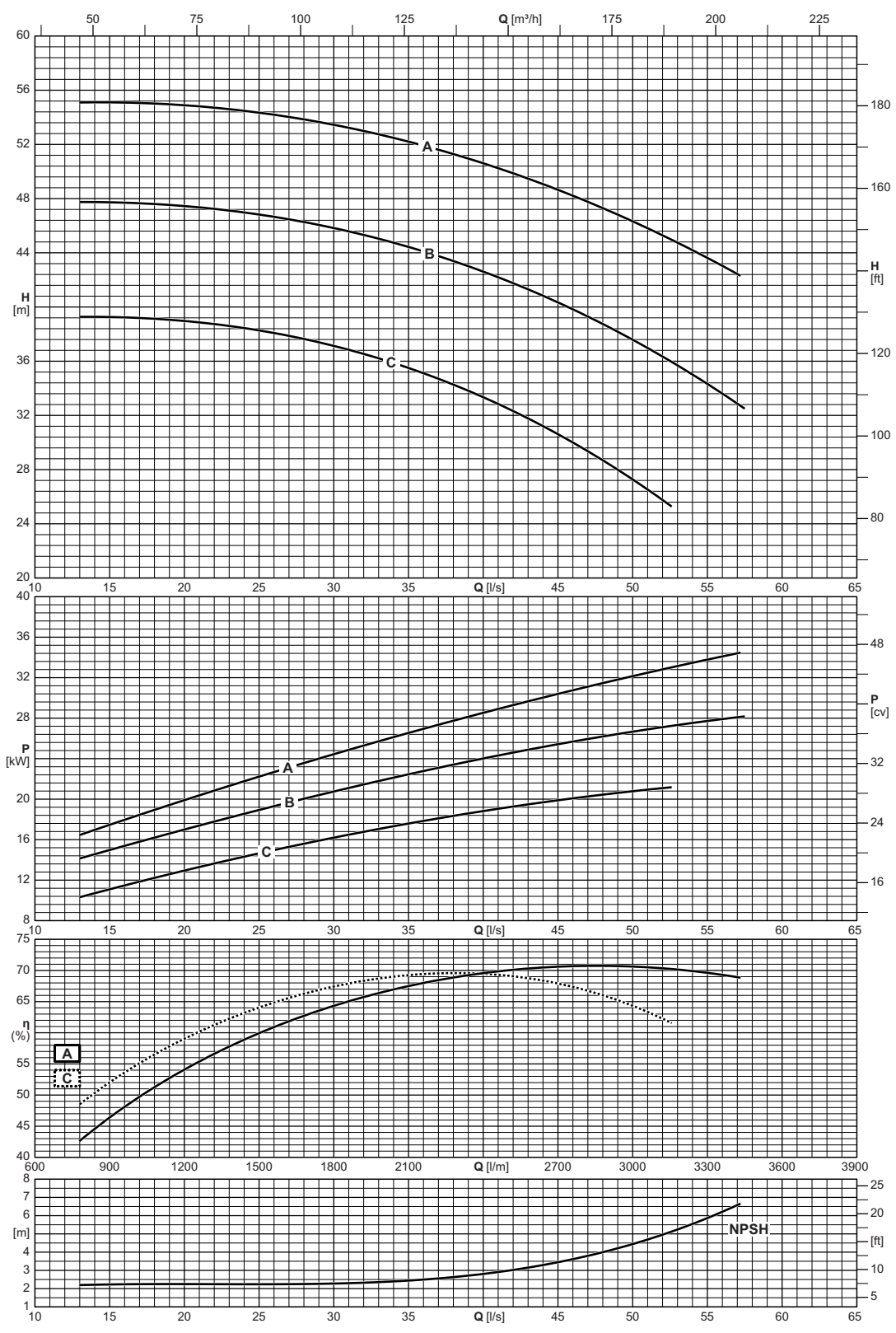

Type Type Tipo	Inlet maximum pressure Pression maximale en aspiration Pressione massima in aspirazione
NCD4P100-400	[bar] 10

Cod. 998911/10-23 - Copyright © 2006 Caprari S.p.A. - All Rights Reserved

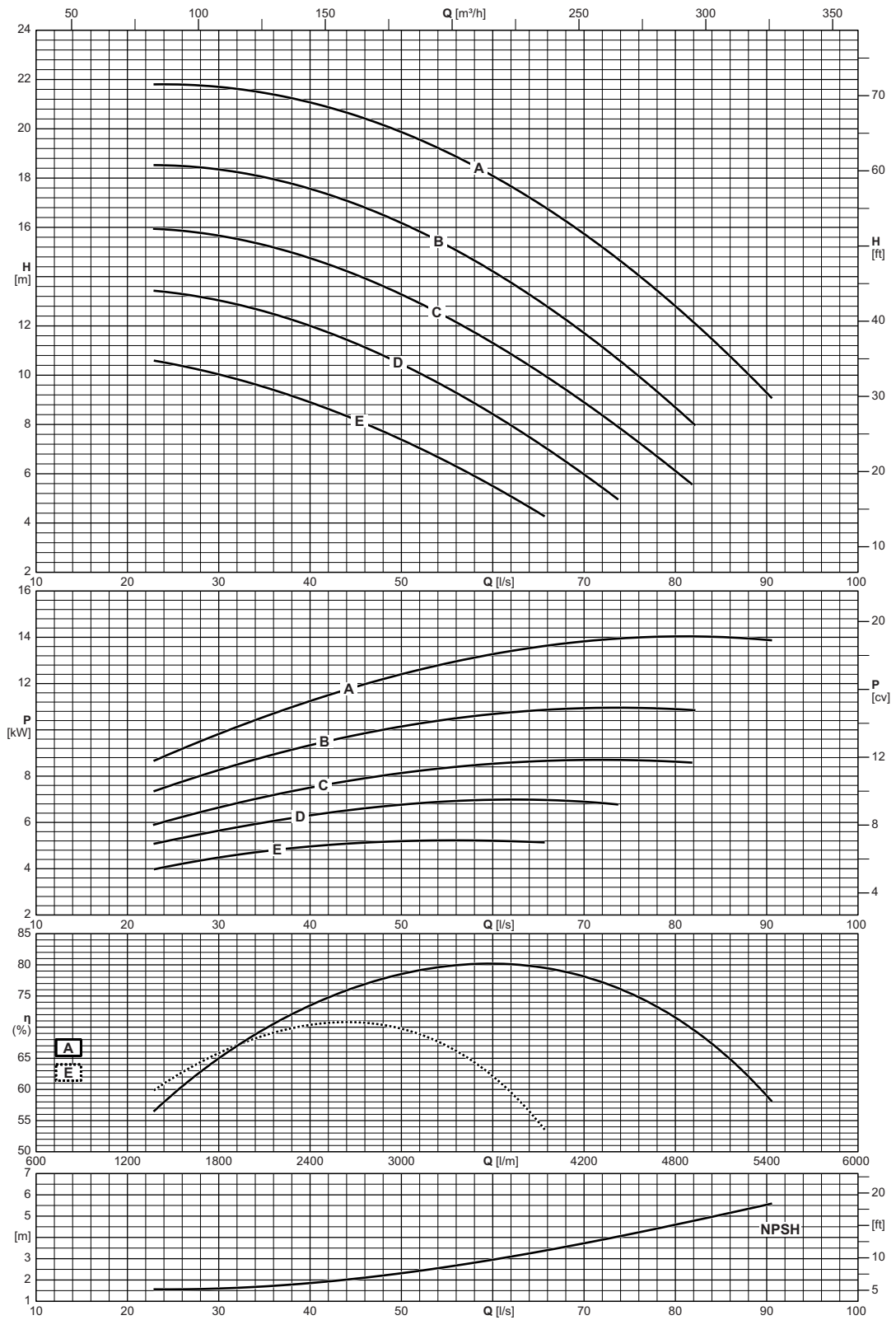

Type Type Tipo	Inlet maximum pressure Pression maximale en aspiration Pressione massima in aspirazione
NCD4P125-250	[bar] 10

NCD 4P125-315

1450 n [min⁻¹]



Operating data
Caracteristiques de fonctionnement
Caratteristiche di funzionamento

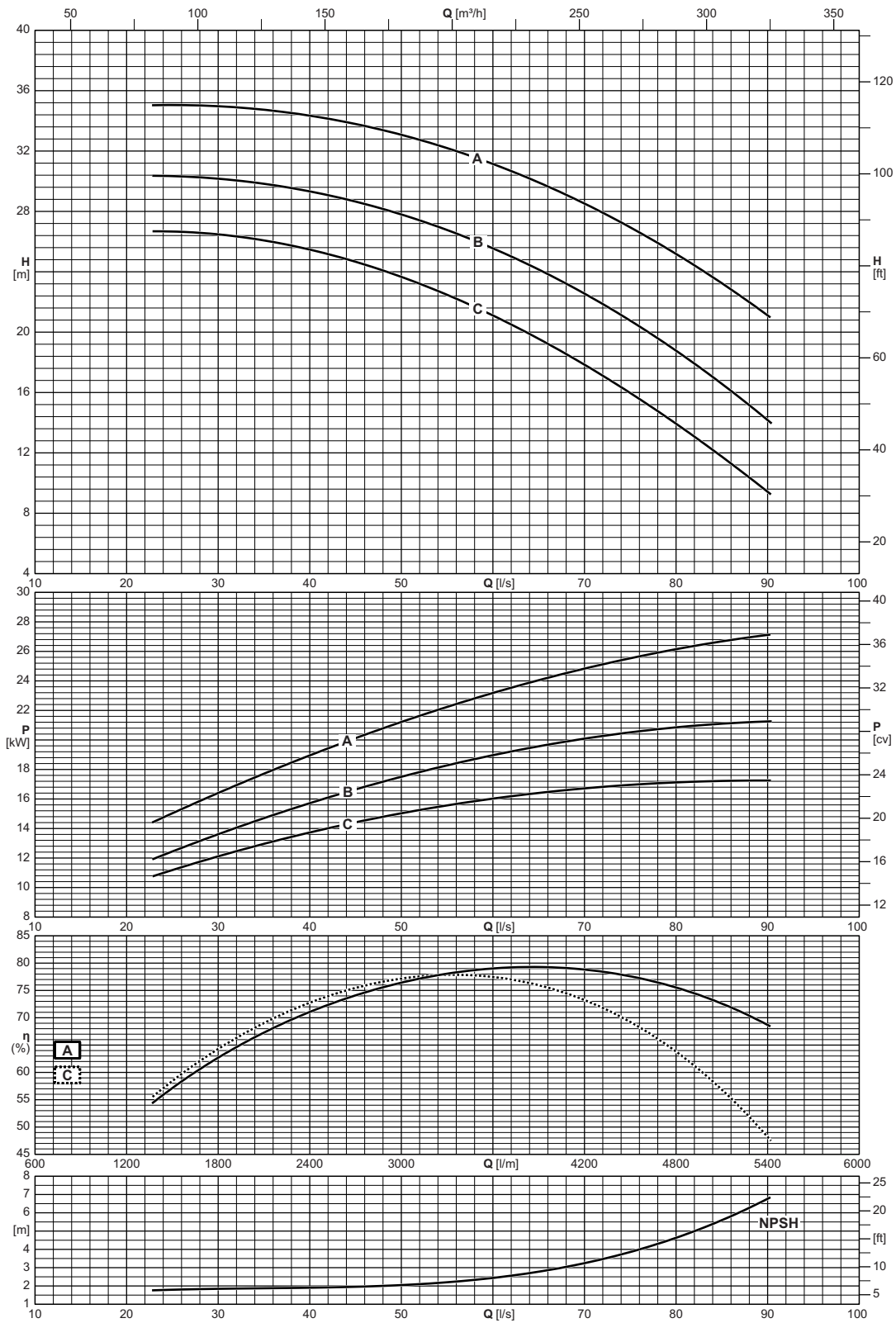

Type Type Tipo	Inlet maximum pressure Pression maximale en aspiration Pressione massima in aspirazione
NCD4P125-315	[bar] 10

Operating data
 Caracteristiques de fonctionnement
 Caratteristiche di funzionamento

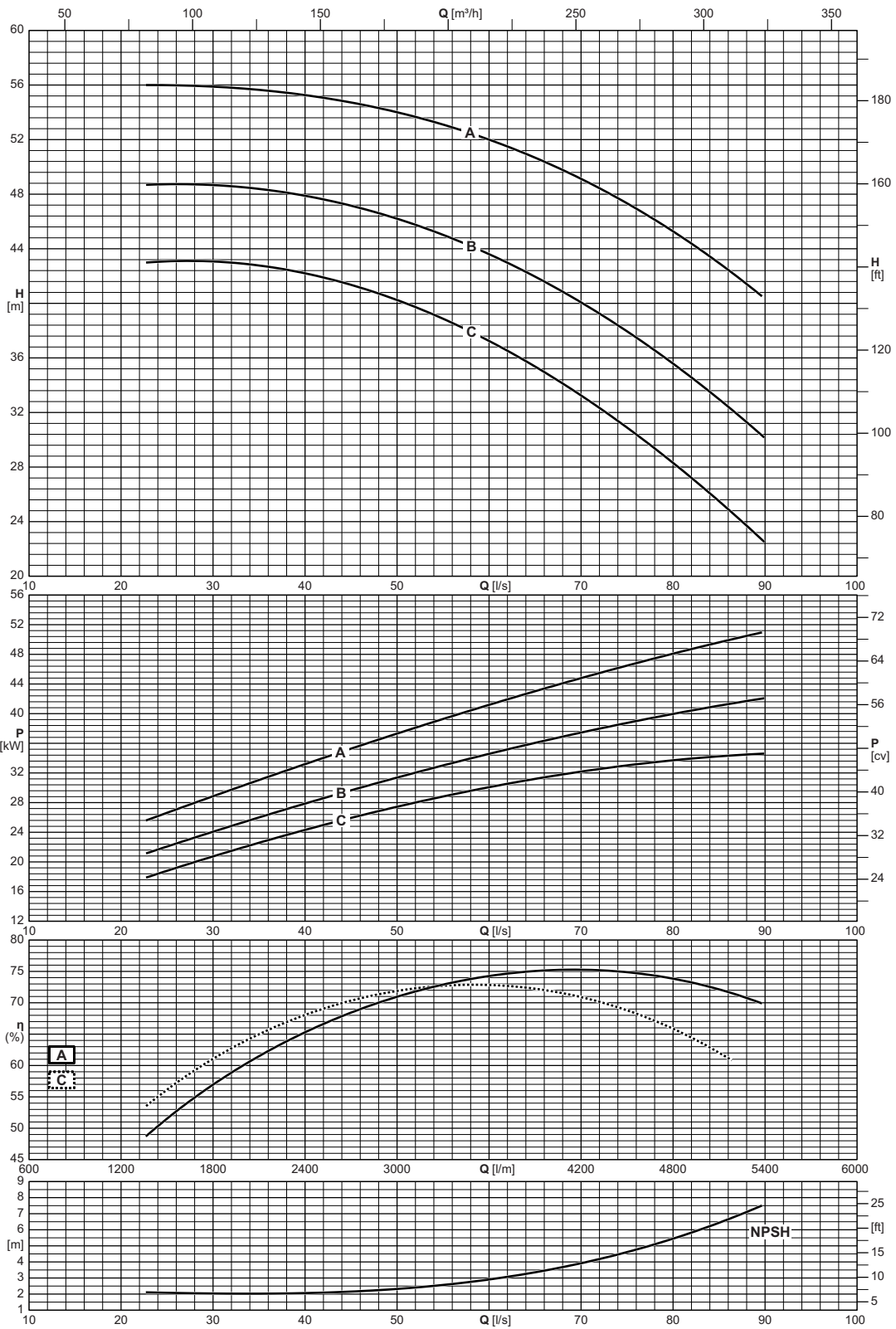

Type Type Tipo	Inlet maximum pressure Pression maximale en aspiration Pressione massima in aspirazione
NCD4P125-400	[bar] 10

NCD 4P150-315

1450 n [min⁻¹]



Operating data
Caracteristiques de fonctionnement
Caratteristiche di funzionamento

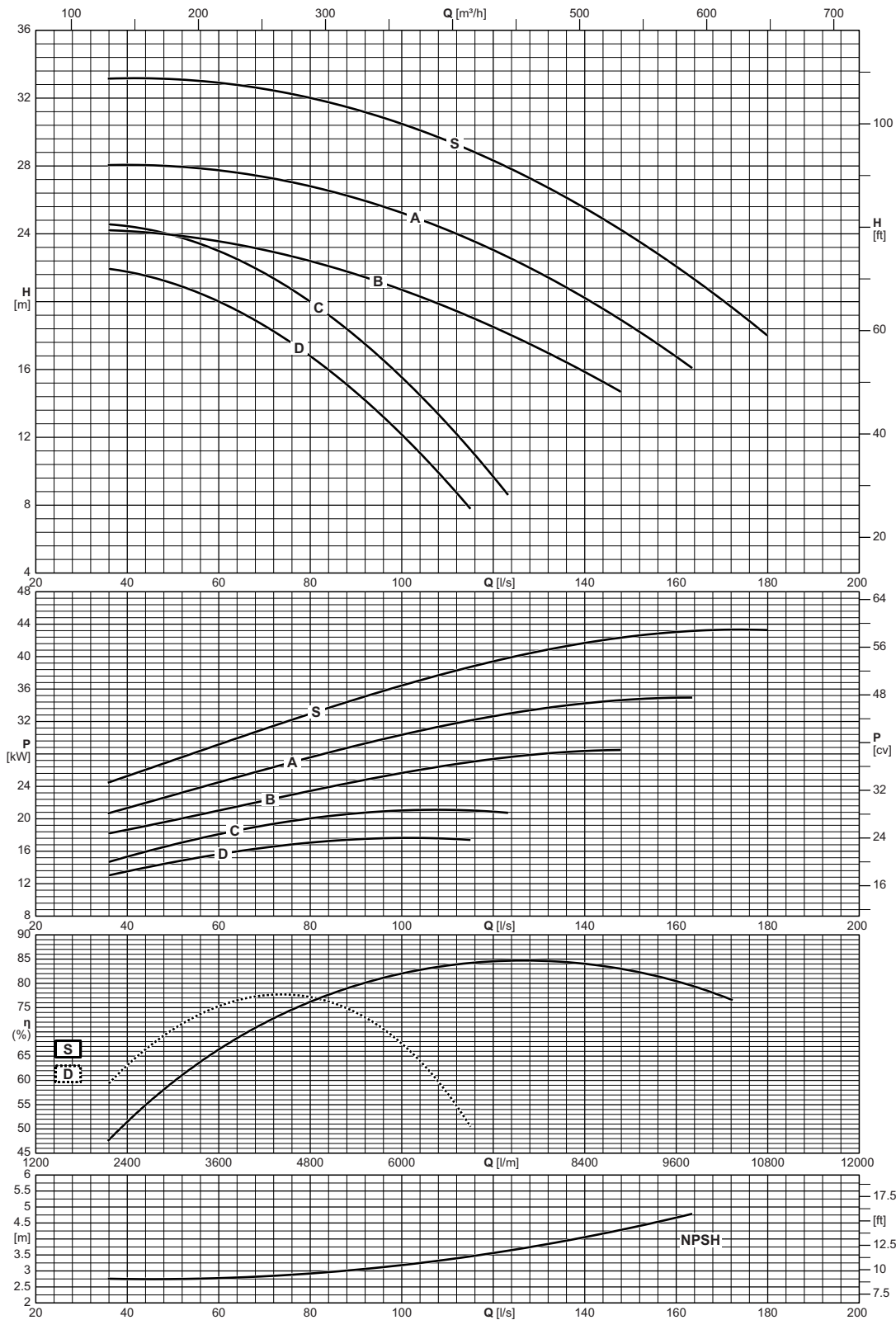

Type Type Tipo	Inlet maximum pressure Pression maximale en aspiration Pressione massima in aspirazione
NCD4P150-315	[bar] 10

Operating data
 Caracteristiques de fonctionnement
 Caratteristiche di funzionamento

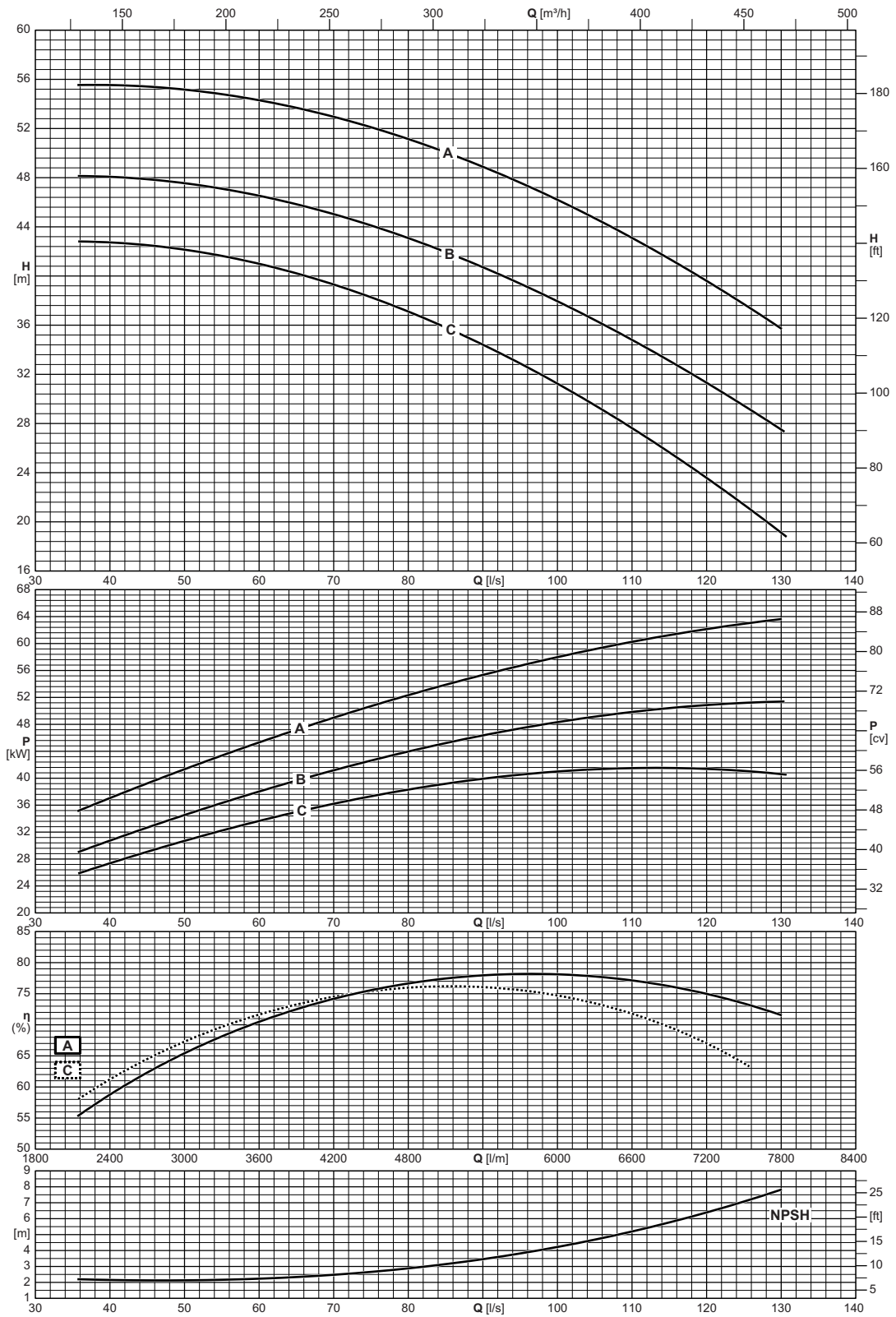

Type Type Tipo	Inlet maximum pressure Pression maximale en aspiration Pressione massima in aspirazione
NCD4P150-400	[bar] 10

NCDS 4P32-160

1750 n [min⁻¹]



Operating data
 Caracteristiques de fonctionnement
 Caratteristiche di funzionamento

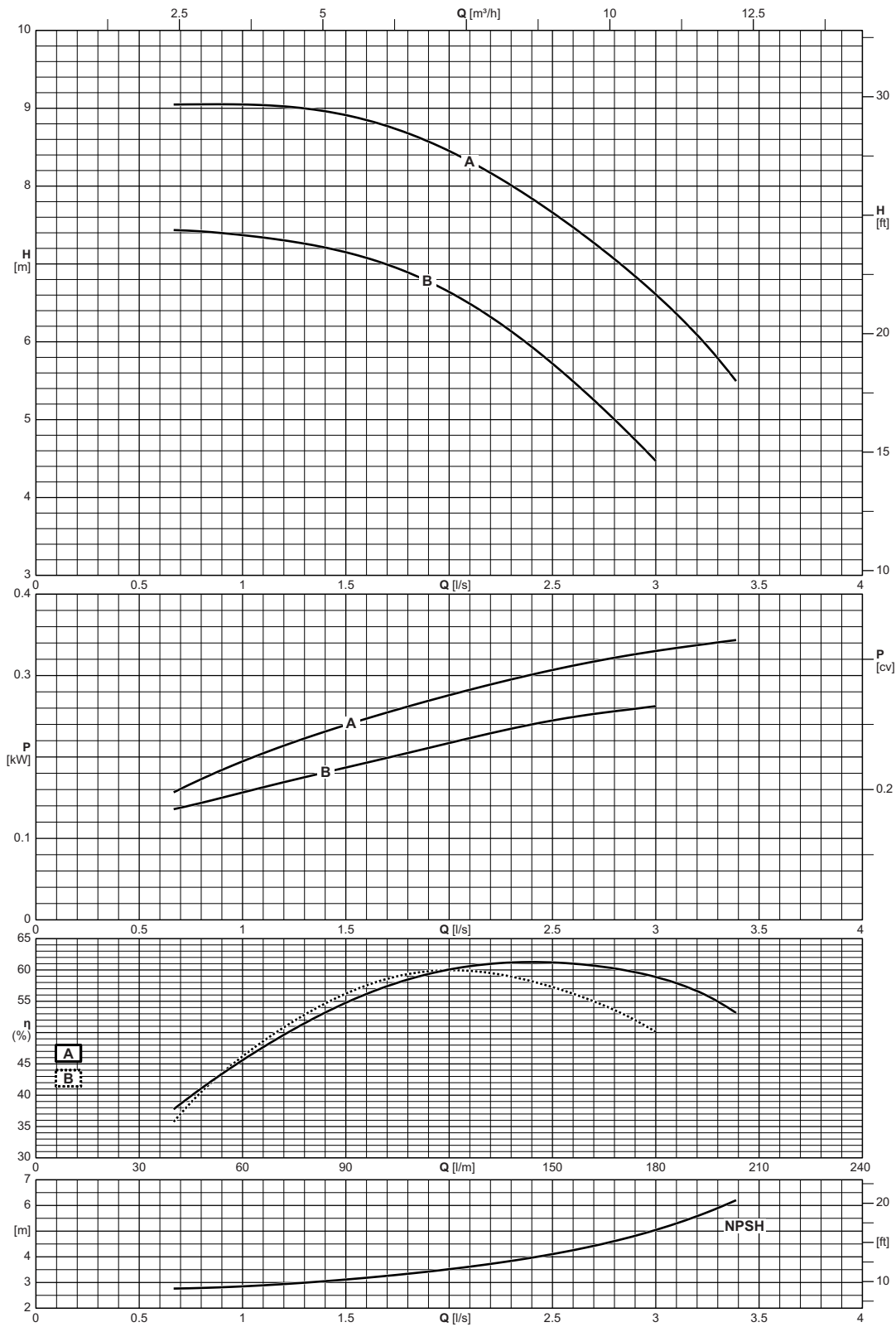

Type Type Tipo	Inlet maximum pressure Pression maximale en aspiration Pressione massima in aspirazione
NCDS4P32-160	[bar] 10

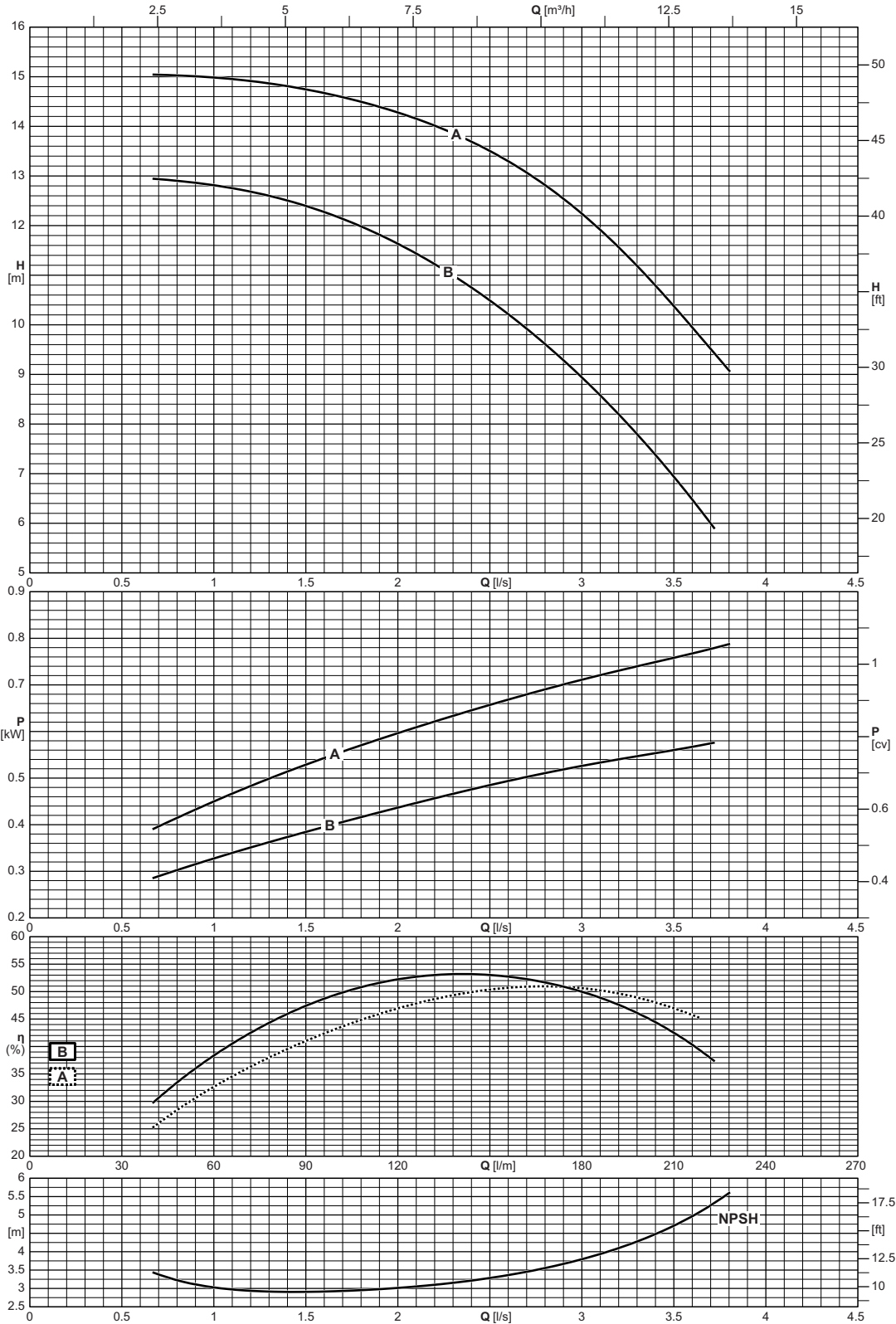

Type Type Tipo	Inlet maximum pressure Pression maximale en aspiration Pressione massima in aspirazione
NCDS4P32-200	[bar] 10

NCDS 4P40-160

1750 n [min⁻¹]



Operating data
 Caracteristiques de fonctionnement
 Caratteristiche di funzionamento

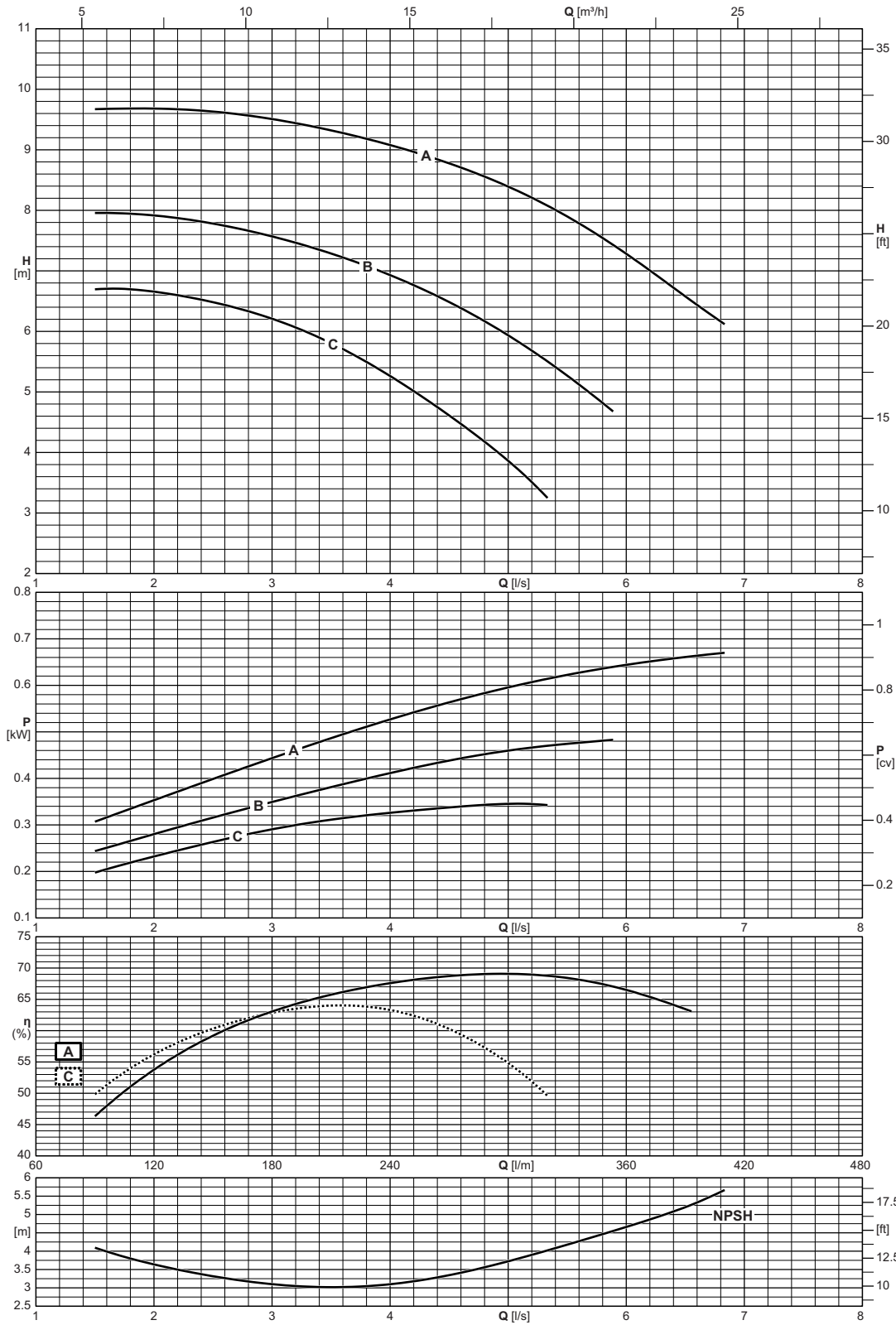

Type Type Tipo	Inlet maximum pressure Pression maximale en aspiration Pressione massima in aspirazione
NCDS4P40-160	[bar]
	10

Operating data
 Caracteristiques de fonctionnement
 Caratteristiche di funzionamento

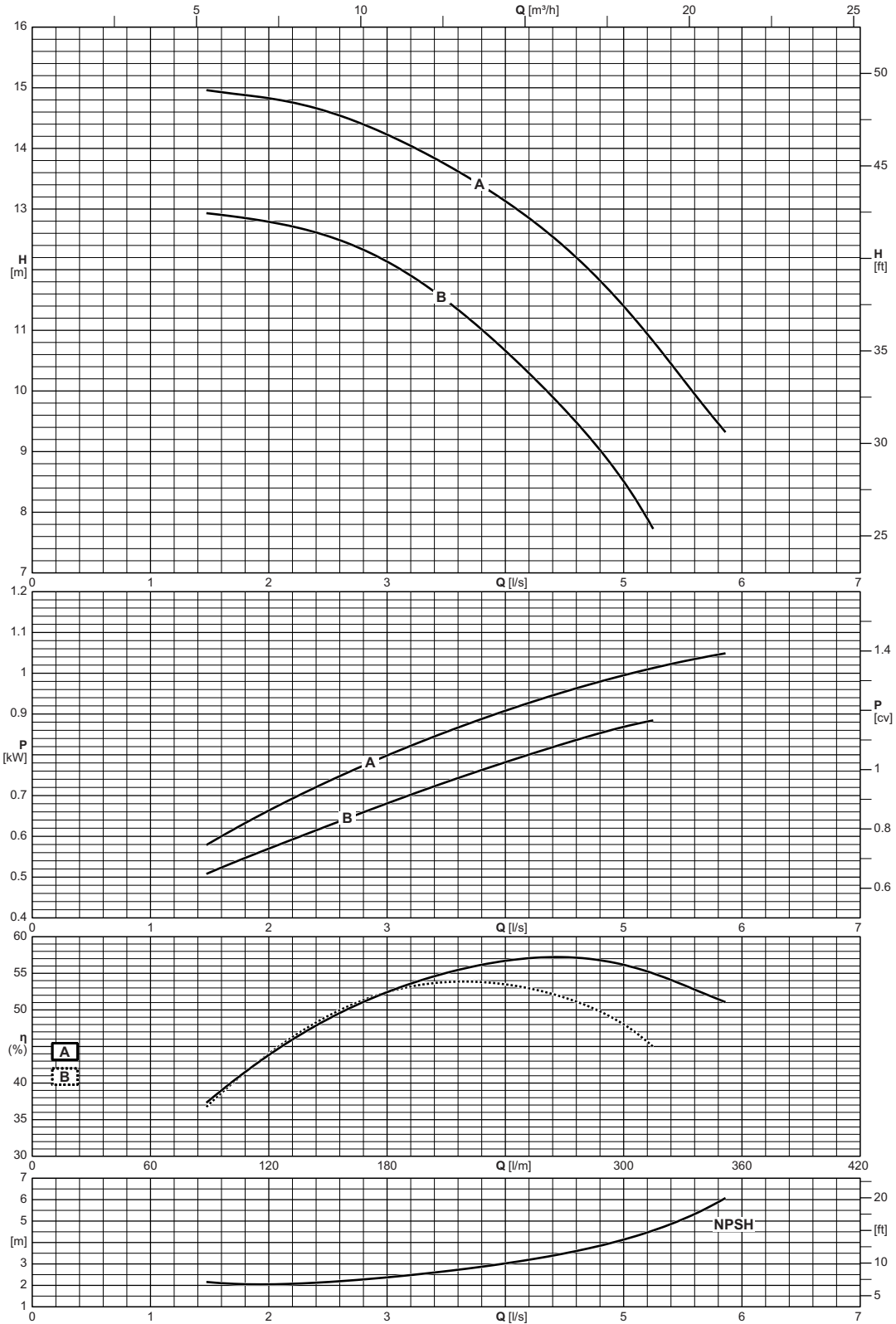

Type Type Tipo	Inlet maximum pressure Pression maximale en aspiration Pressione massima in aspirazione
NCDS4P40-200	[bar] 10

NCDS 4P40-250

1750 n [min⁻¹]



Operating data
Caracteristiques de fonctionnement
Caratteristiche di funzionamento

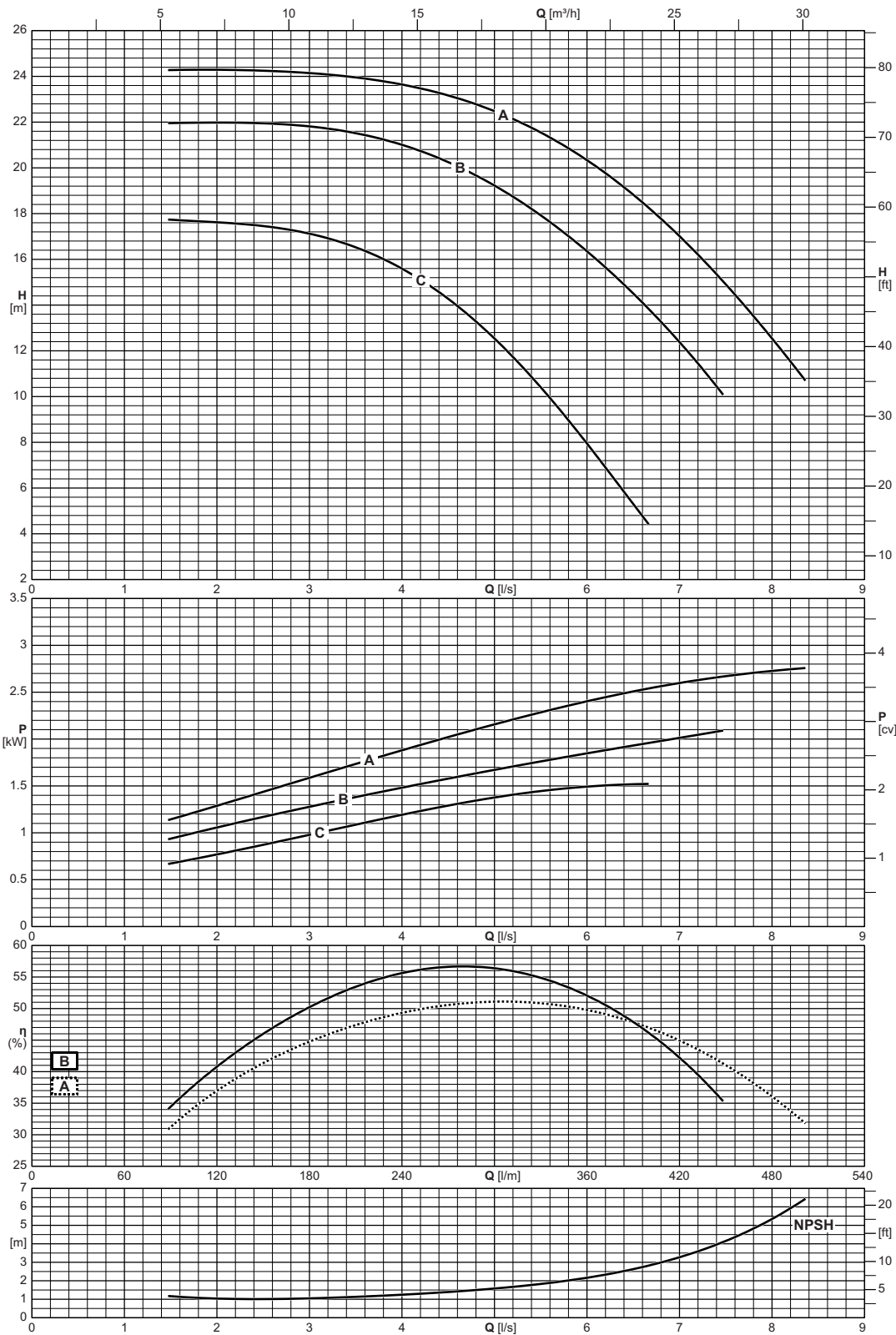

Type Type Tipo	Inlet maximum pressure Pression maximale en aspiration Pressione massima in aspirazione
NCDS4P40-250	[bar] 10

Operating data
 Caracteristiques de fonctionnement
 Caratteristiche di funzionamento

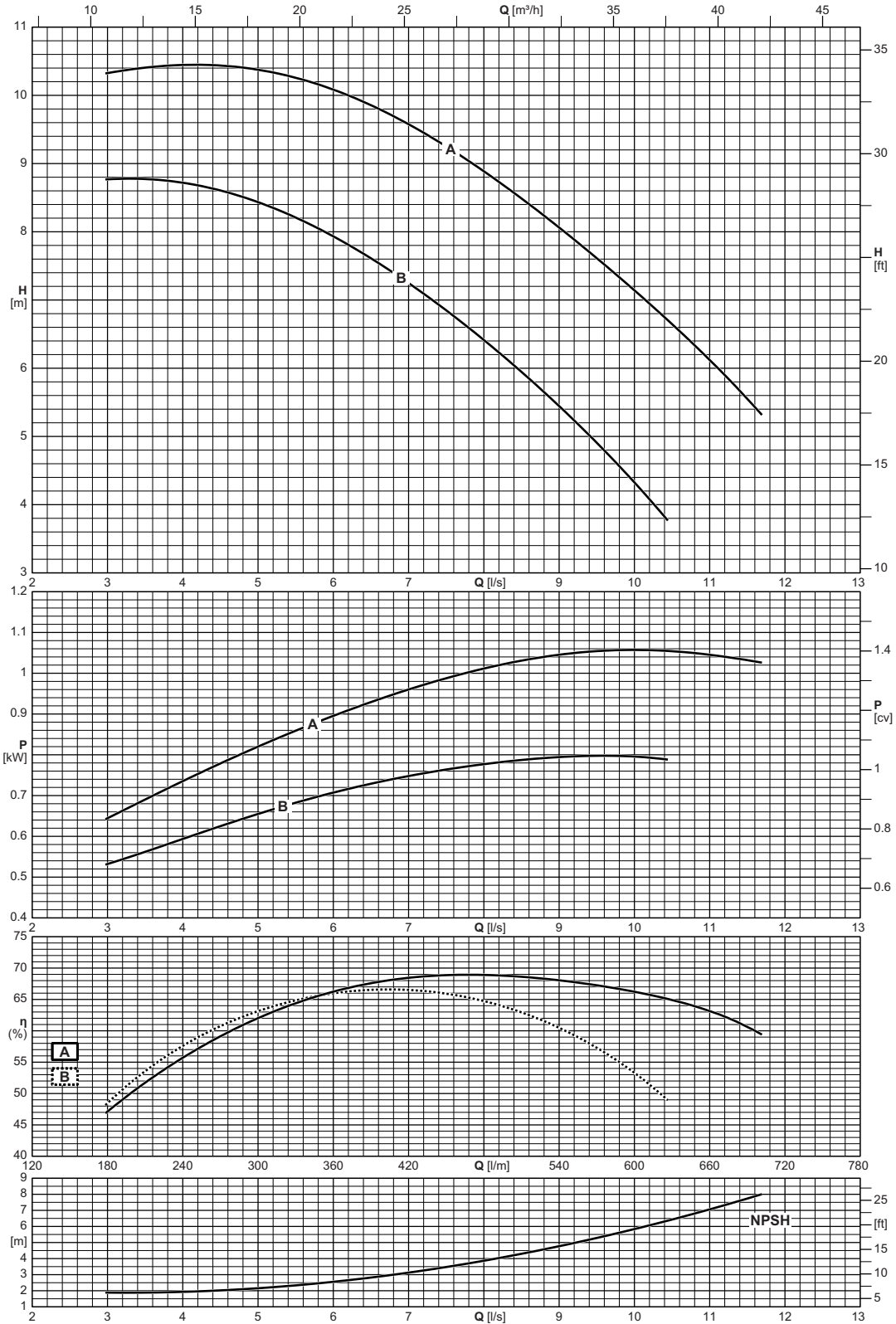

Type Type Tipo	Inlet maximum pressure Pression maximale en aspiration Pressione massima in aspirazione
NCDS4P50-160	[bar] 10

NCDS 4P50-200

1750 n [min⁻¹]



Operating data
 Caracteristiques de fonctionnement
 Caratteristiche di funzionamento

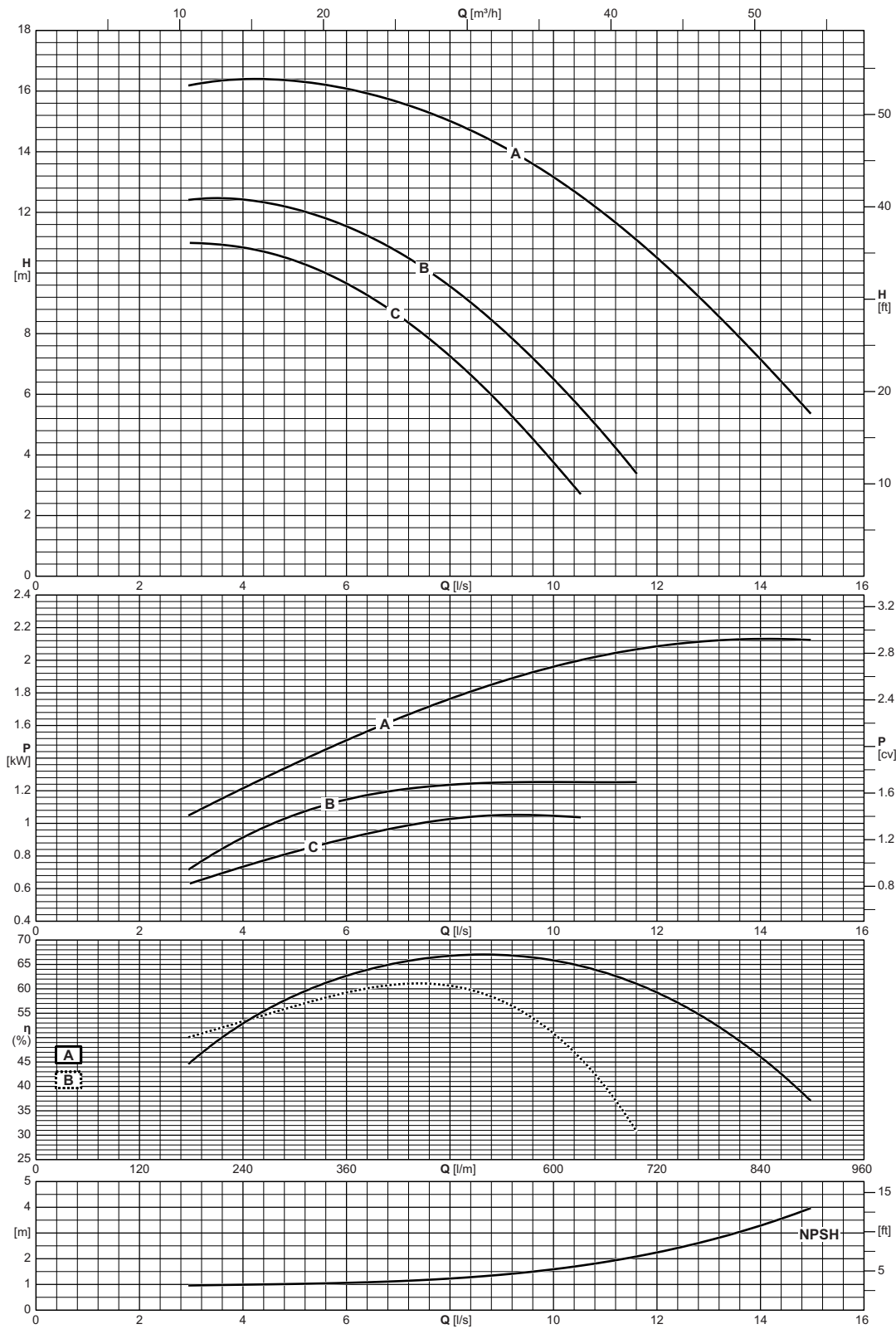

Type Type Tipo	Inlet maximum pressure Pression maximale en aspiration Pressione massima in aspirazione
NCDS4P50-200	[bar] 10

Operating data
 Caracteristiques de fonctionnement
 Caratteristiche di funzionamento

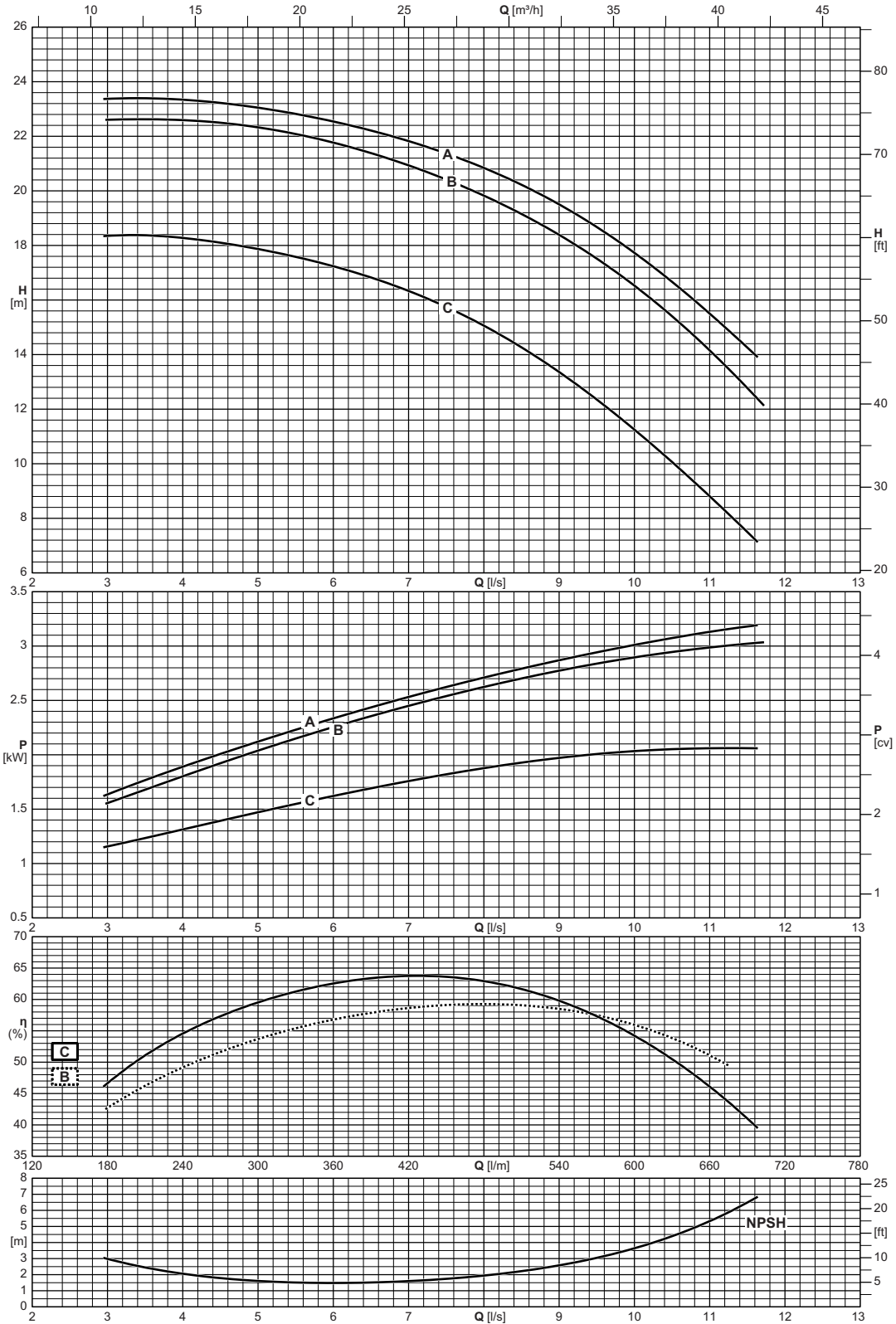

Type Type Tipo	Inlet maximum pressure Pression maximale en aspiration Pressione massima in aspirazione
NCDS4P50-250	[bar] 10

NCDS 4P65-125

1750 n [min⁻¹]



Operating data
 Caracteristiques de fonctionnement
 Caratteristiche di funzionamento

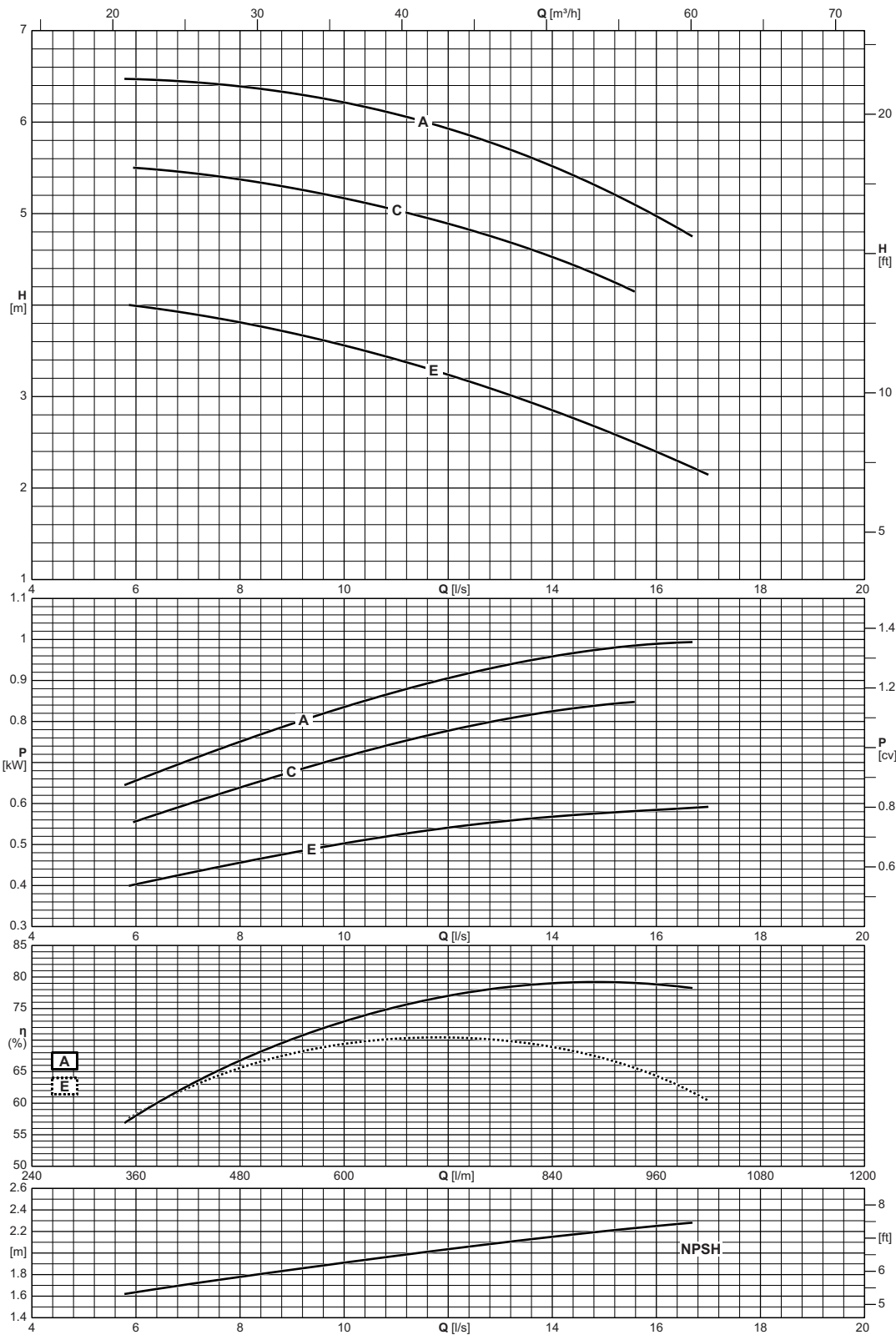

Type Type Tipo	Inlet maximum pressure Pression maximale en aspiration Pressione massima in aspirazione
NCDS4P65-125	[bar] 10

Operating data
 Caracteristiques de fonctionnement
 Caratteristiche di funzionamento

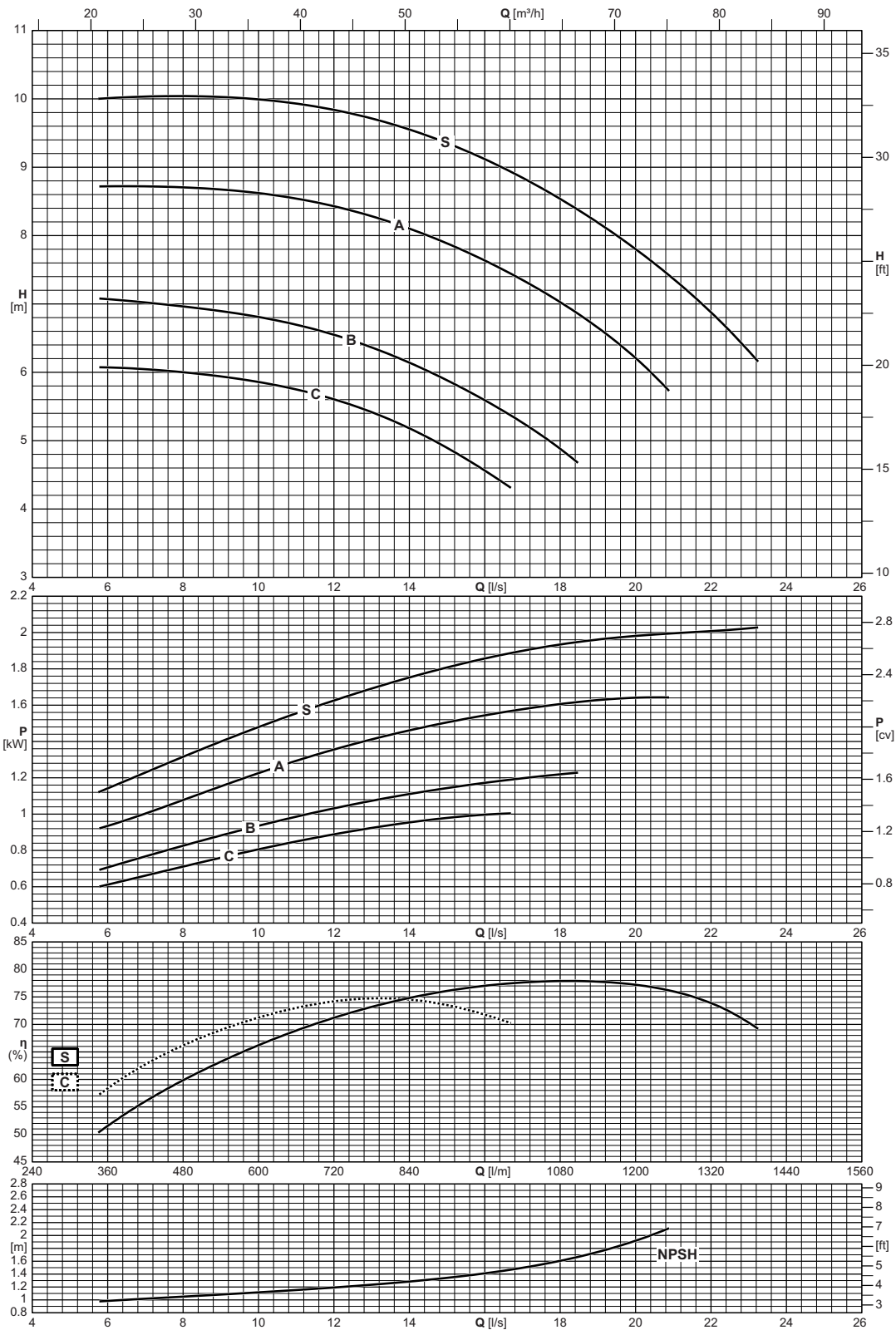

Type Type Tipo	Inlet maximum pressure Pression maximale en aspiration Pressione massima in aspirazione
NCDS4P65-160	[bar] 10

NCDS 4P65-200

1750 n [min⁻¹]



Operating data
 Caracteristiques de fonctionnement
 Caratteristiche di funzionamento

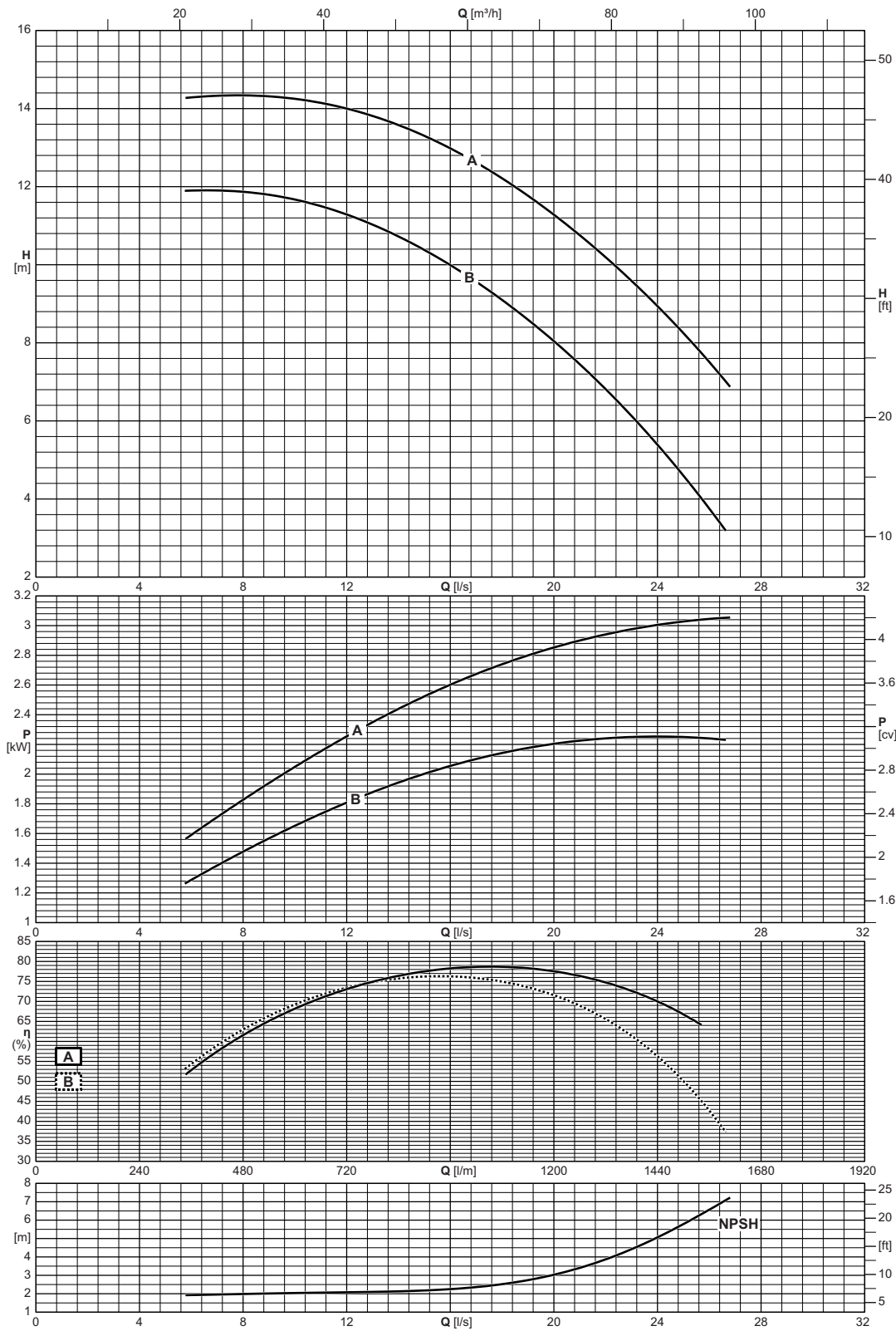

Type Type Tipo	Inlet maximum pressure Pression maximale en aspiration Pressione massima in aspirazione
NCDS4P65-200	[bar] 10

Operating data
 Caracteristiques de fonctionnement
 Caratteristiche di funzionamento

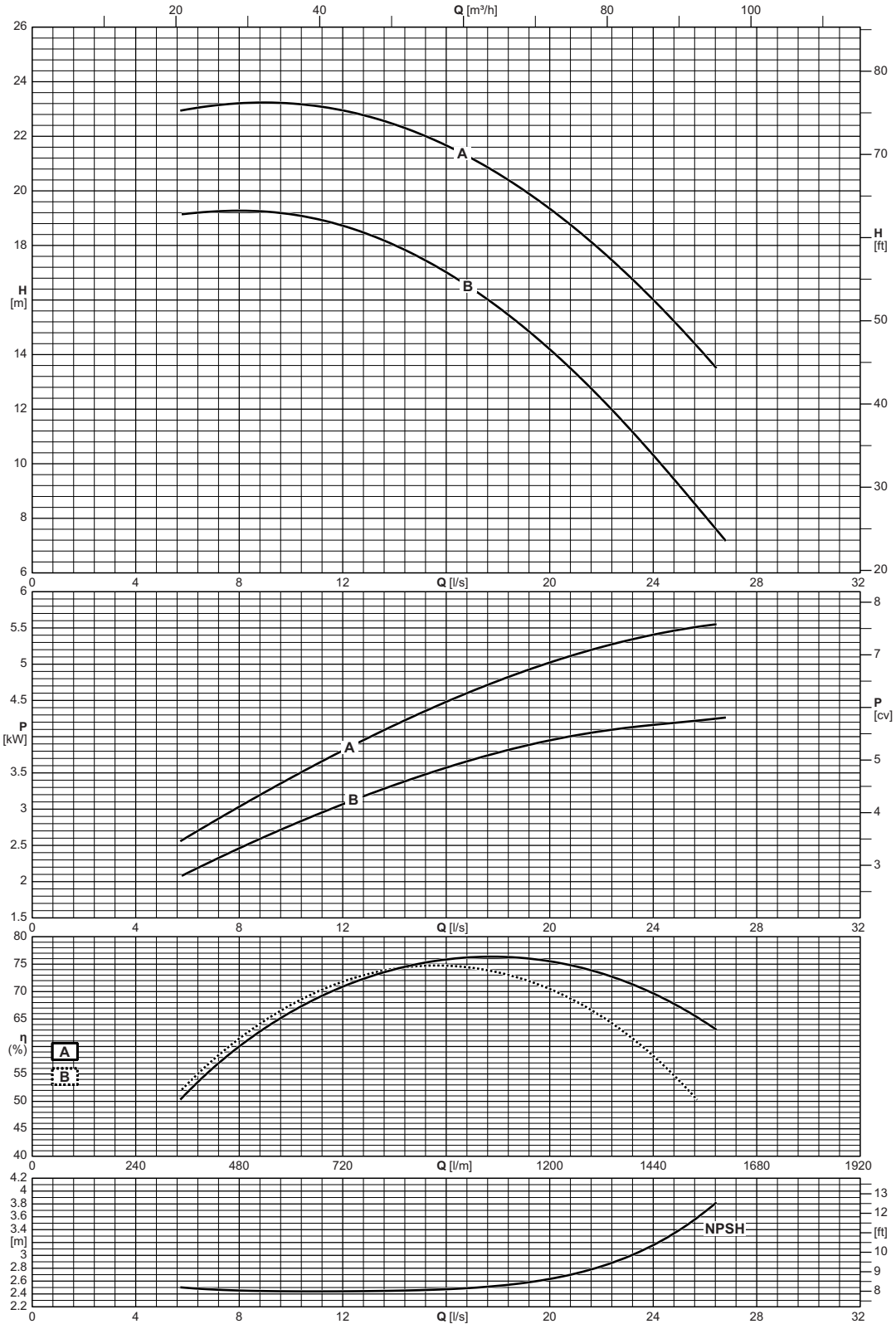

Type Type Tipo	Inlet maximum pressure Pression maximale en aspiration Pressione massima in aspirazione
NCDS4P65-250	[bar] 10

NCDS 4P65-315

1750 n [min⁻¹]



Operating data
 Caracteristiques de fonctionnement
 Caratteristiche di funzionamento

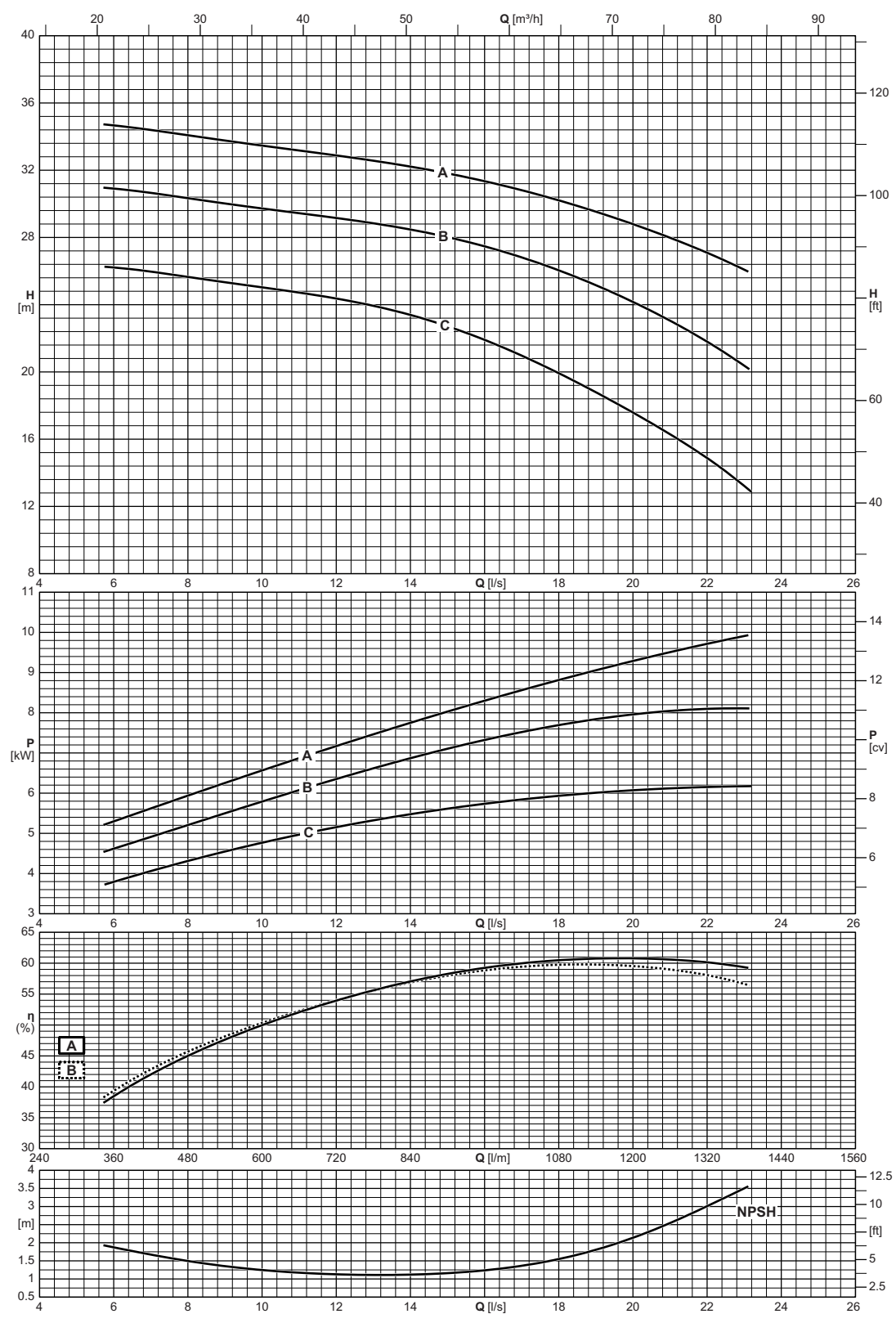

Type Type Tipo	Inlet maximum pressure Pression maximale en aspiration Pressione massima in aspirazione
NCDS4P65-315	[bar] 10

Cod. 998911/10-23 - Copyright © 2006 Caprari S.p.A. - All Rights Reserved

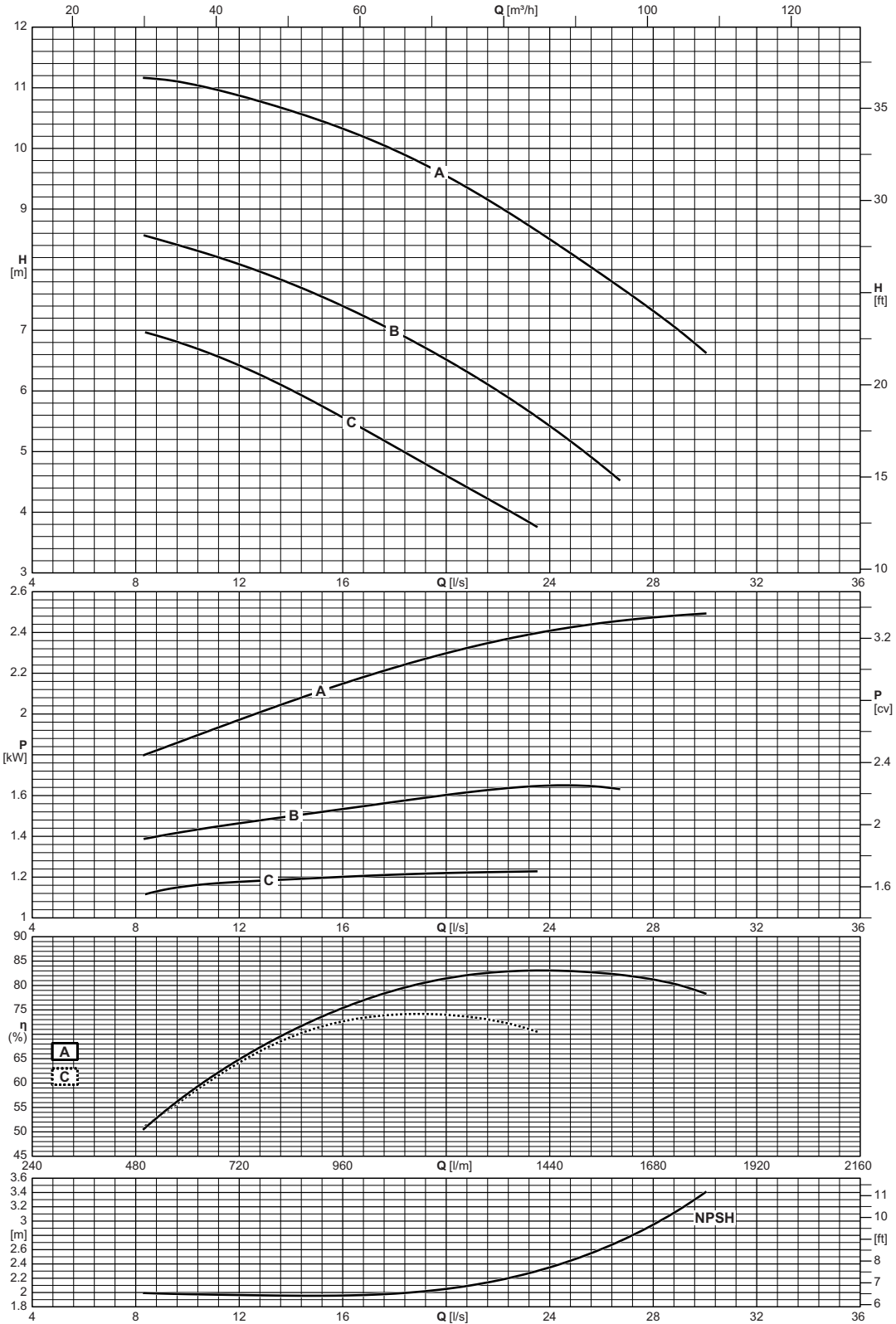

Type Type Tipo	Inlet maximum pressure Pression maximale en aspiration Pressione massima in aspirazione
NCDS4P80-160	[bar] 10

NCDS 4P80-200

1750 n [min⁻¹]



Operating data
 Caracteristiques de fonctionnement
 Caratteristiche di funzionamento

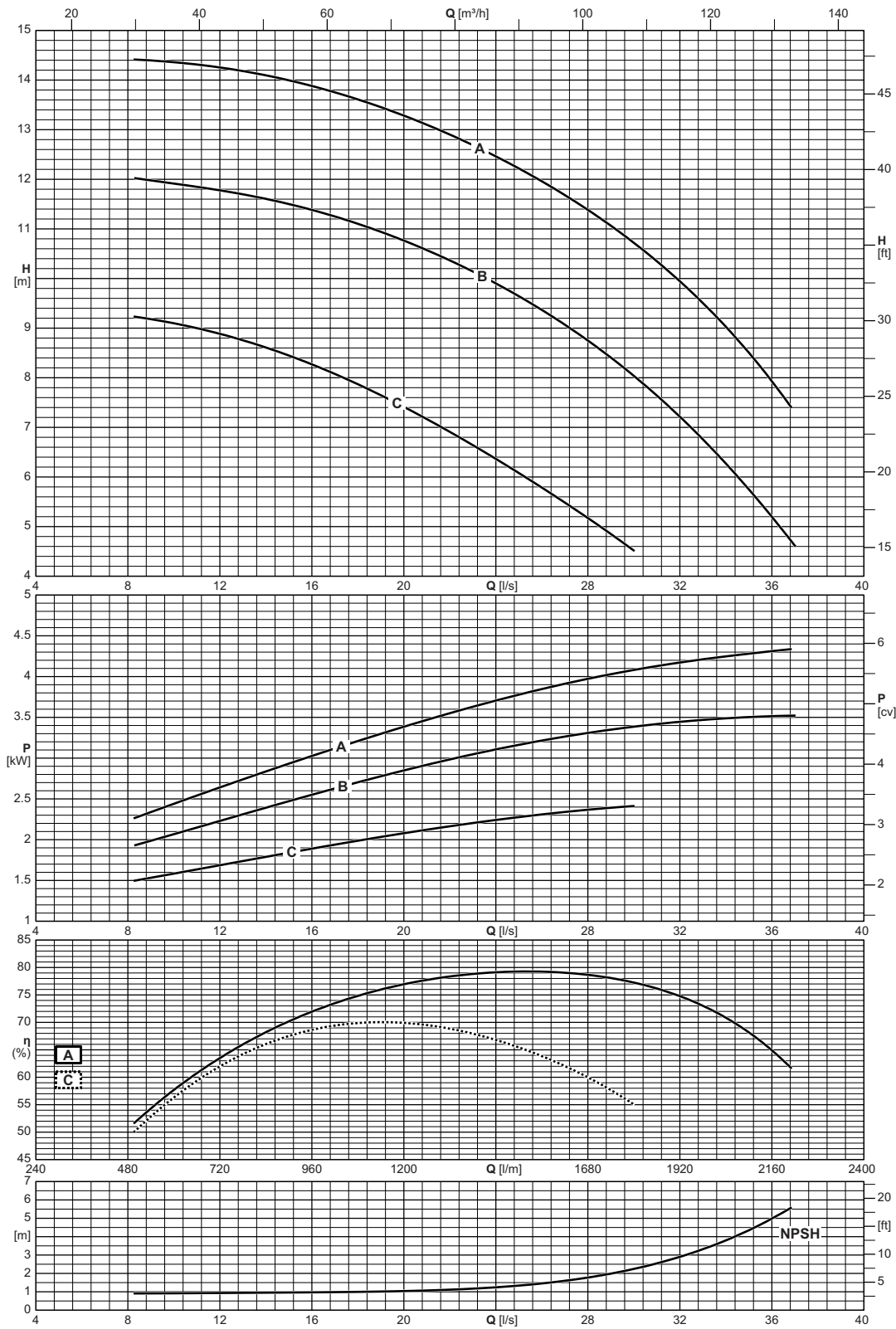

Type Type Tipo	Inlet maximum pressure Pression maximale en aspiration Pressione massima in aspirazione
NCDS4P80-200	[bar] 10

Operating data
 Caracteristiques de fonctionnement
 Caratteristiche di funzionamento

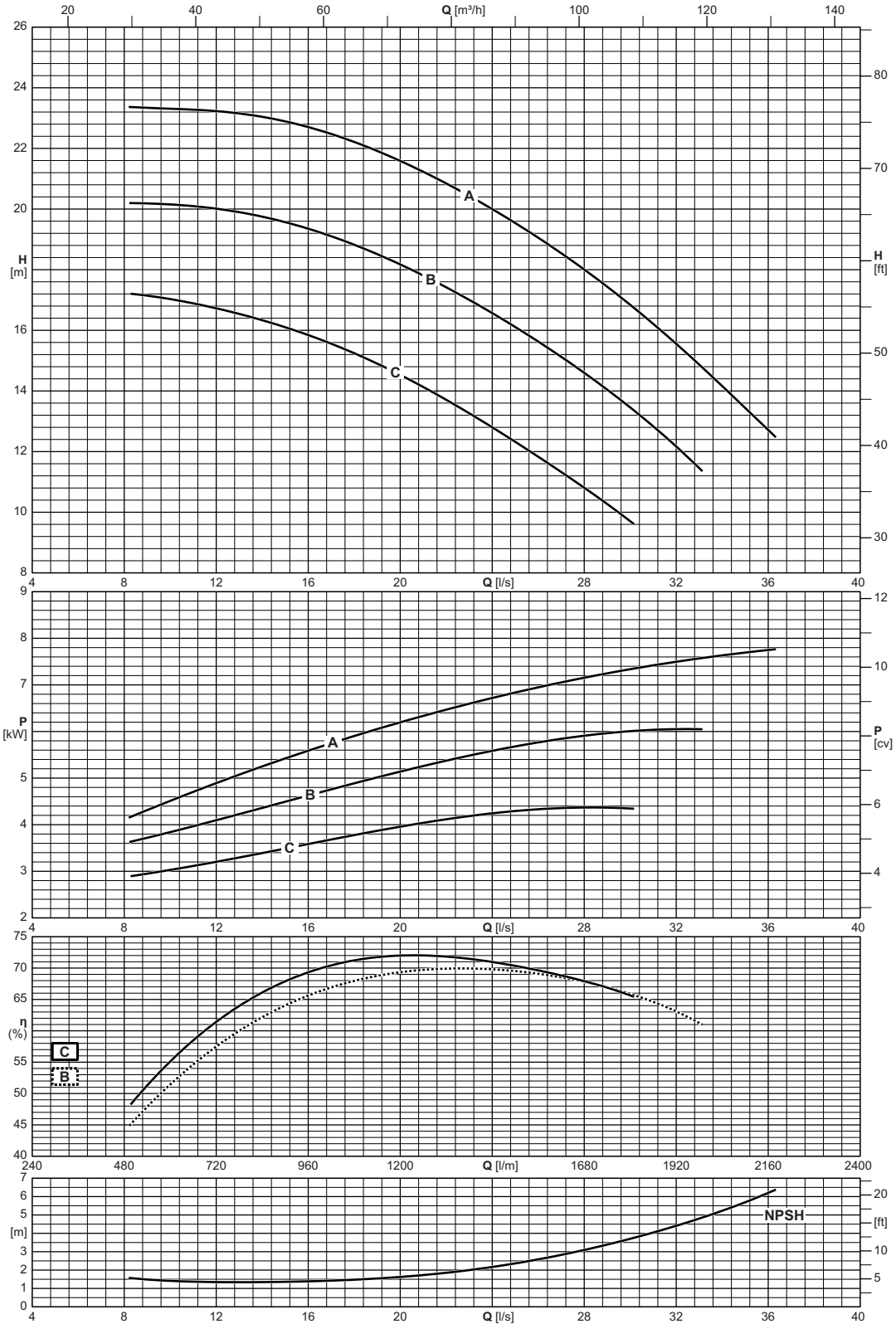

Type Type Tipo	Inlet maximum pressure Pression maximale en aspiration Pressione massima in aspirazione
NCDS4P80-250	[bar] 10

NCDS 4P80-315

1750 n [min⁻¹]



Operating data
Caracteristiques de fonctionnement
Caratteristiche di funzionamento

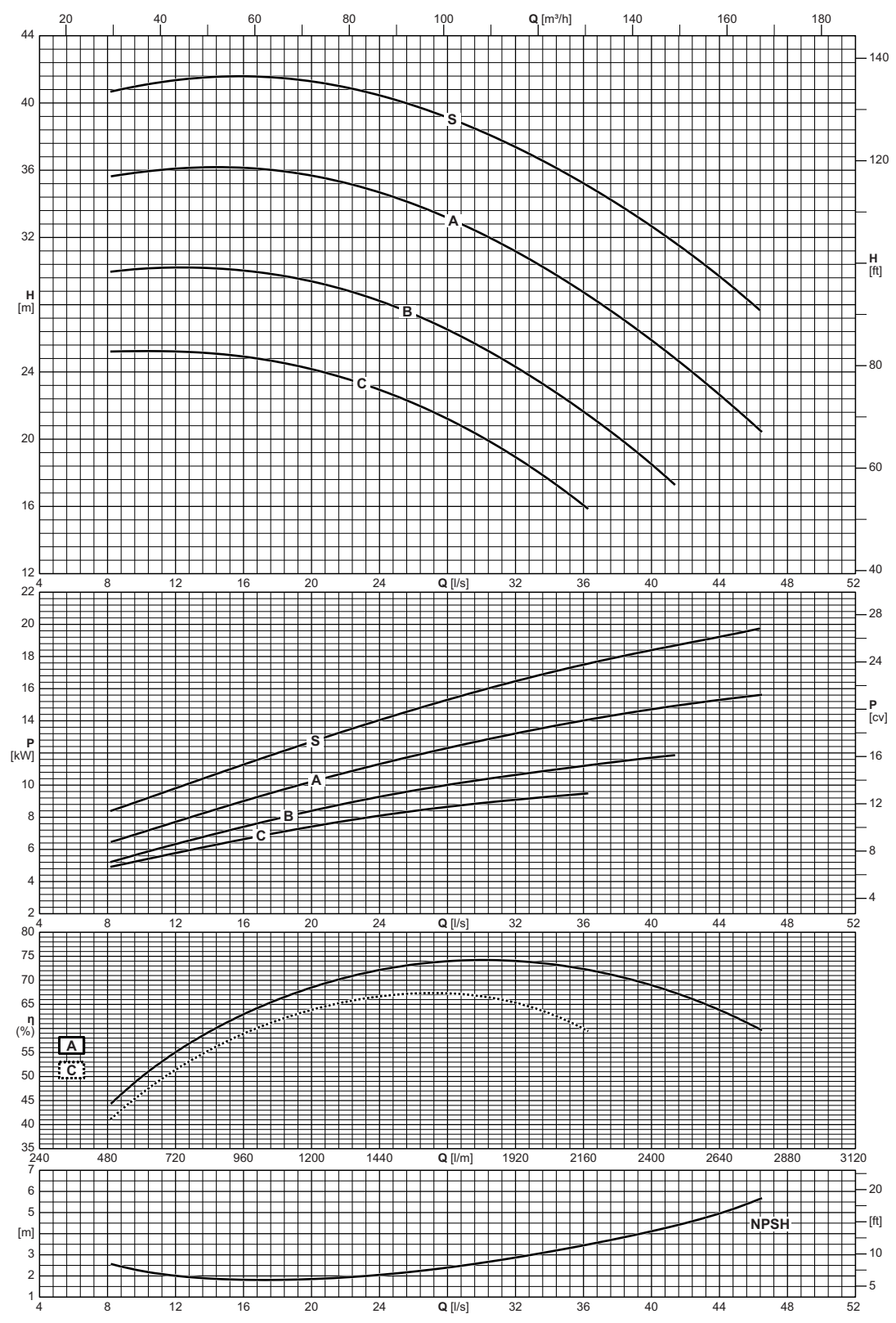

Type Type Tipo	Inlet maximum pressure Pression maximale en aspiration Pressione massima in aspirazione
NCDS4P80-315	[bar]
	10

Cod. 998911/10-23 - Copyright © 2006 Caprari S.p.A. - All Rights Reserved

Operating data
 Caracteristiques de fonctionnement
 Caratteristiche di funzionamento

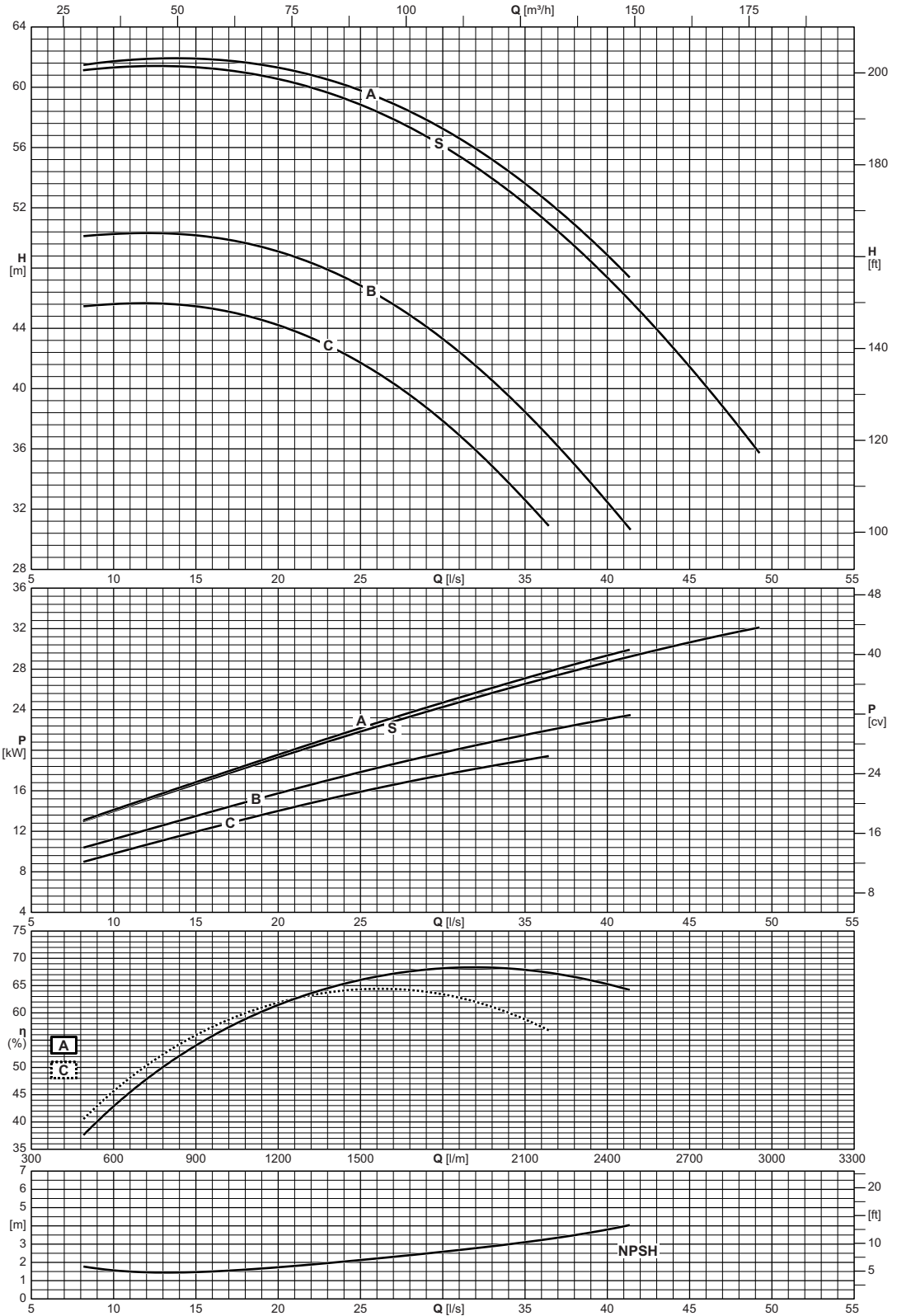

Type Type Tipo	Inlet maximum pressure Pression maximale en aspiration Pressione massima in aspirazione
NCDS4P80-400	[bar] 10

NCDS 4P100-200

1750 n [min⁻¹]



Operating data
Caracteristiques de fonctionnement
Caratteristiche di funzionamento

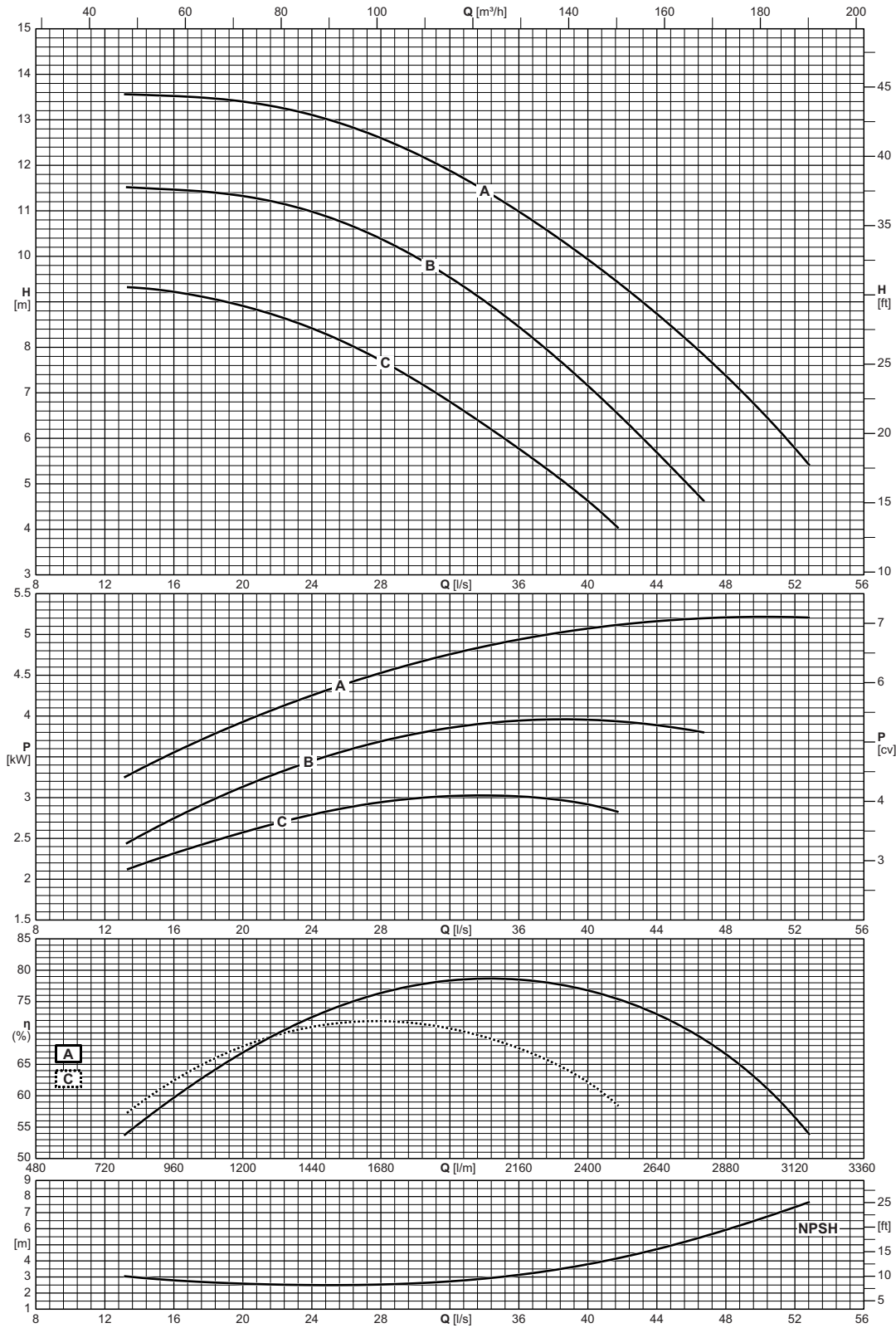

Type Type Tipo	Inlet maximum pressure Pression maximale en aspiration Pressione massima in aspirazione
NCDS4P100-200	[bar] 10

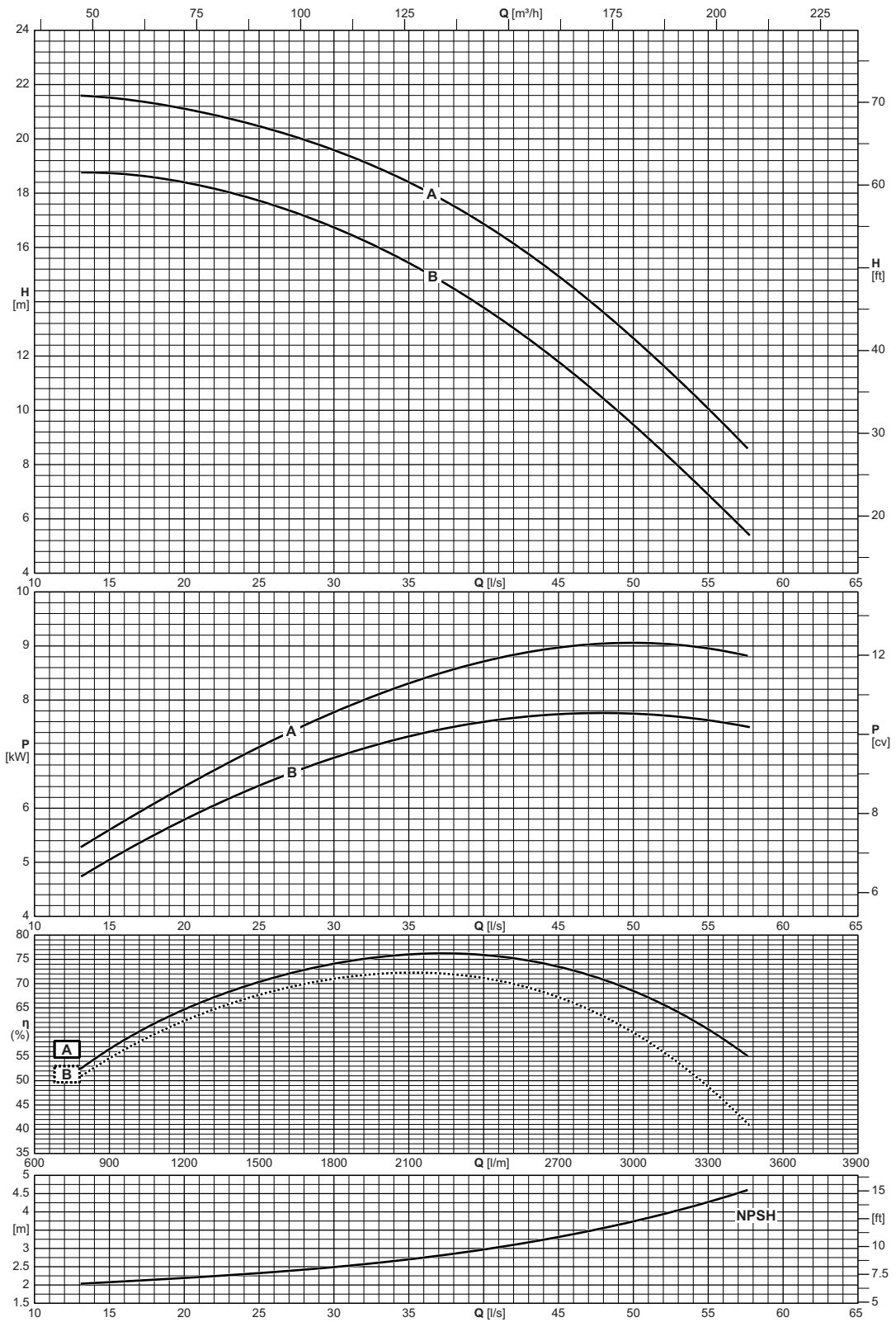

Type Type Tipo	Inlet maximum pressure Pression maximale en aspiration Pressione massima in aspirazione
NCDS4P100-250	[bar] 10

NCDS 4P100-315

1750 n [min⁻¹]



Operating data
Caracteristiques de fonctionnement
Caratteristiche di funzionamento

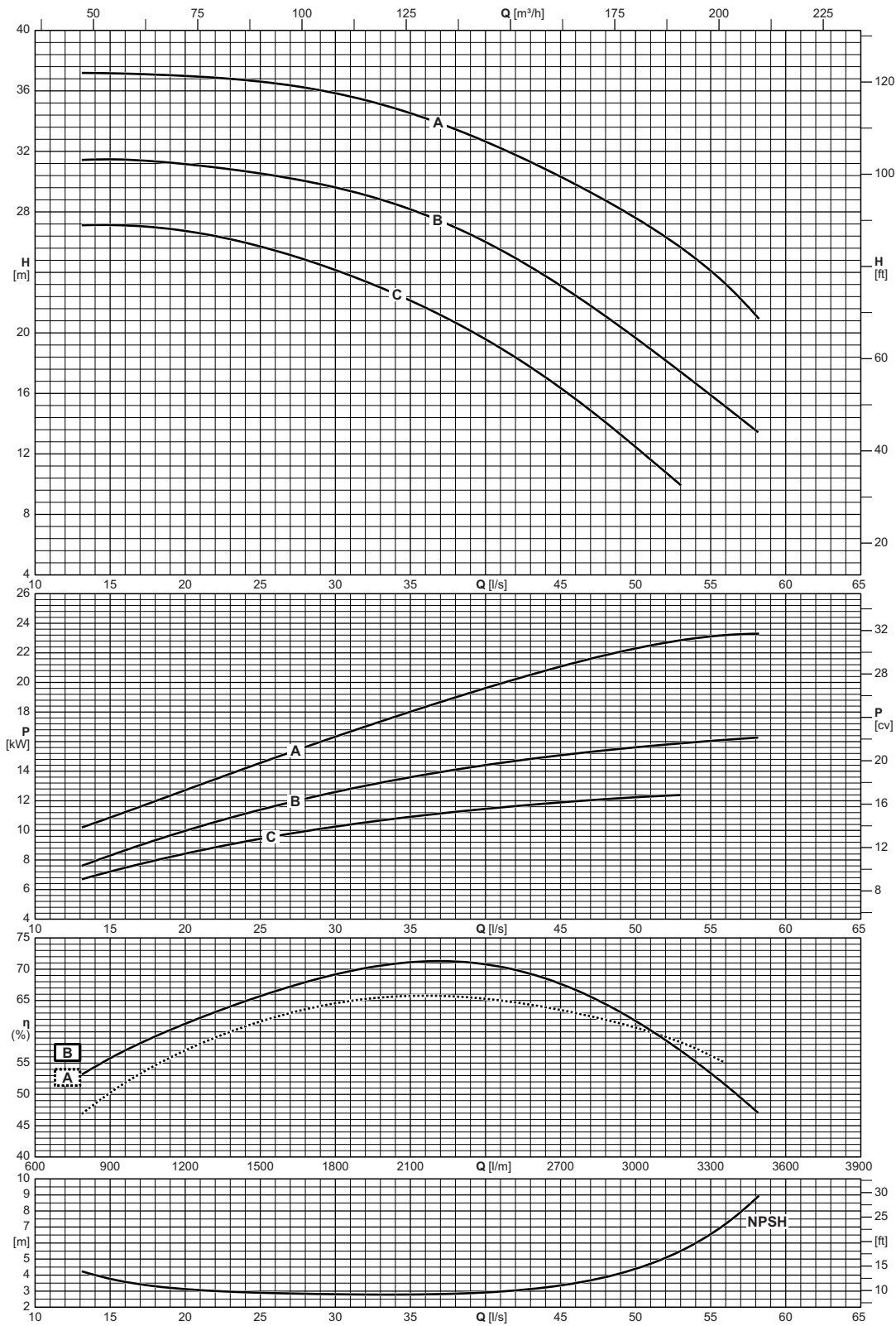

Type Type Tipo	Inlet maximum pressure Pression maximale en aspiration Pressione massima in aspirazione
NCDS4P100-315	[bar] 10

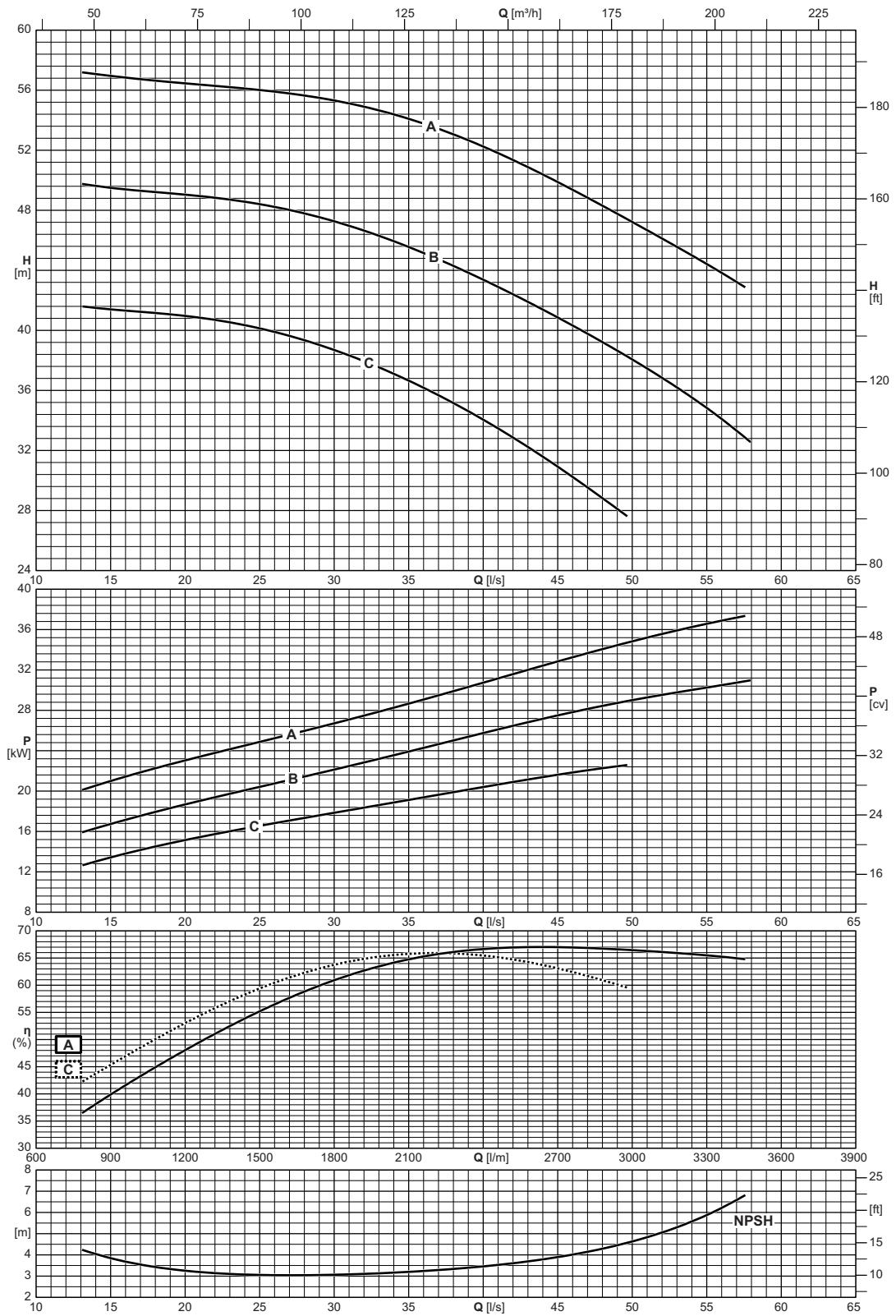

Type Type Tipo	Inlet maximum pressure Pression maximale en aspiration Pressione massima in aspirazione
NCDS4P100-400	[bar] 10

NCDS 4P125-250

1750 n [min⁻¹]



Operating data
Caracteristiques de fonctionnement
Caratteristiche di funzionamento

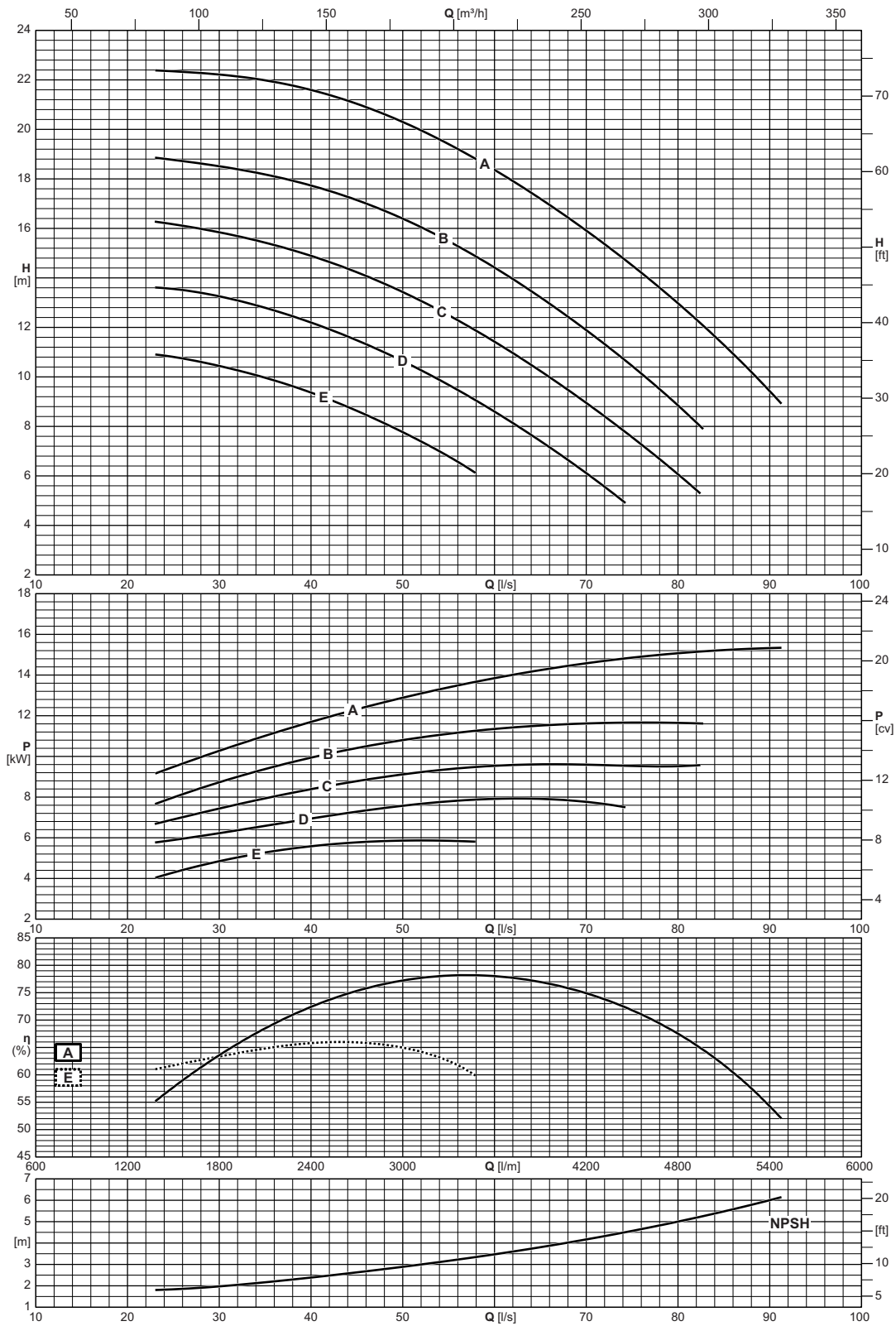

Type Type Tipo	Inlet maximum pressure Pression maximale en aspiration Pressione massima in aspirazione
NCDS4P125-250	[bar] 10

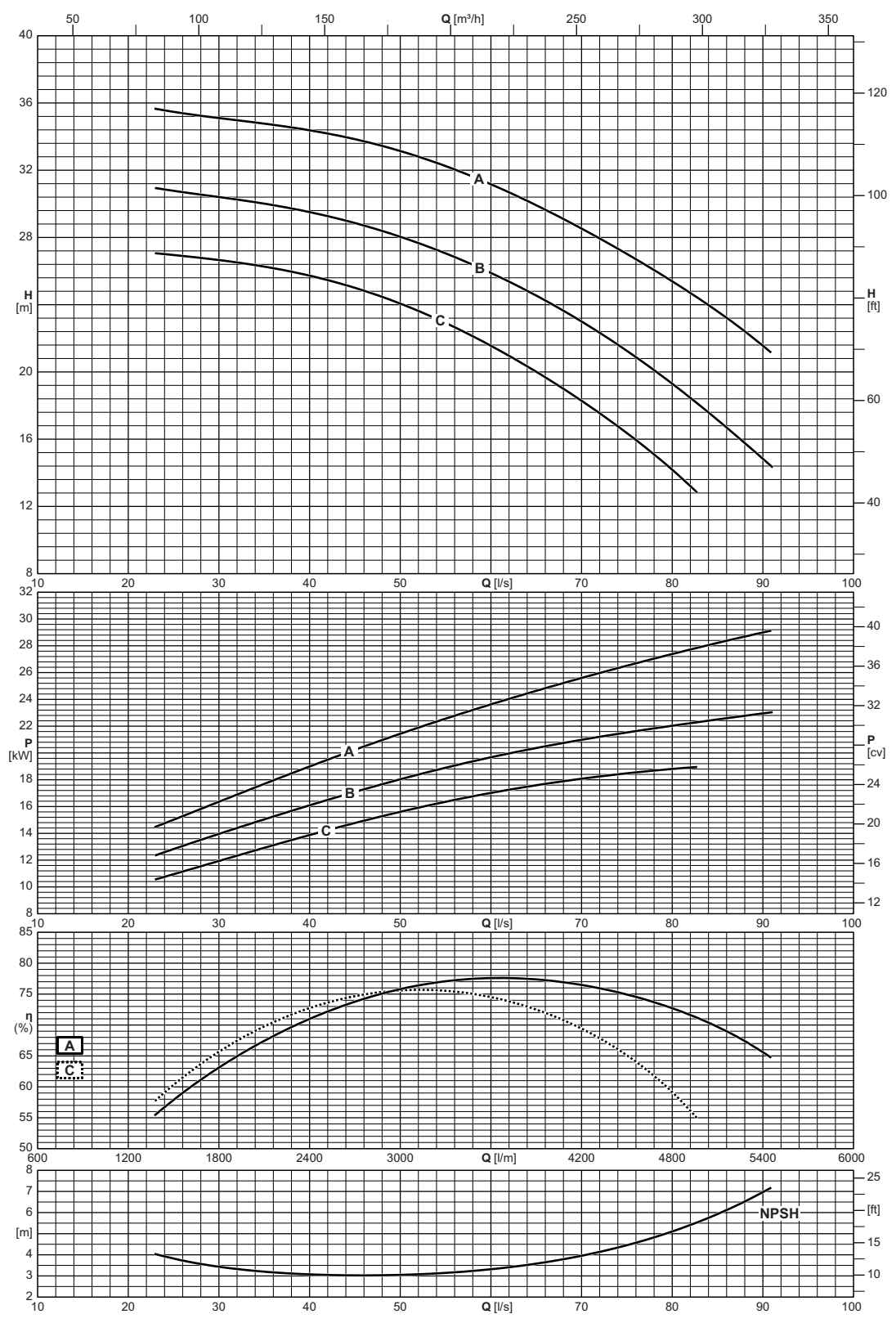

Type Type Tipo	Inlet maximum pressure Pression maximale en aspiration Pressione massima in aspirazione
NCDS4P125-315	[bar] 10

NCDS 4P125-400

1750 n [min⁻¹]



Operating data
Caracteristiques de fonctionnement
Caratteristiche di funzionamento

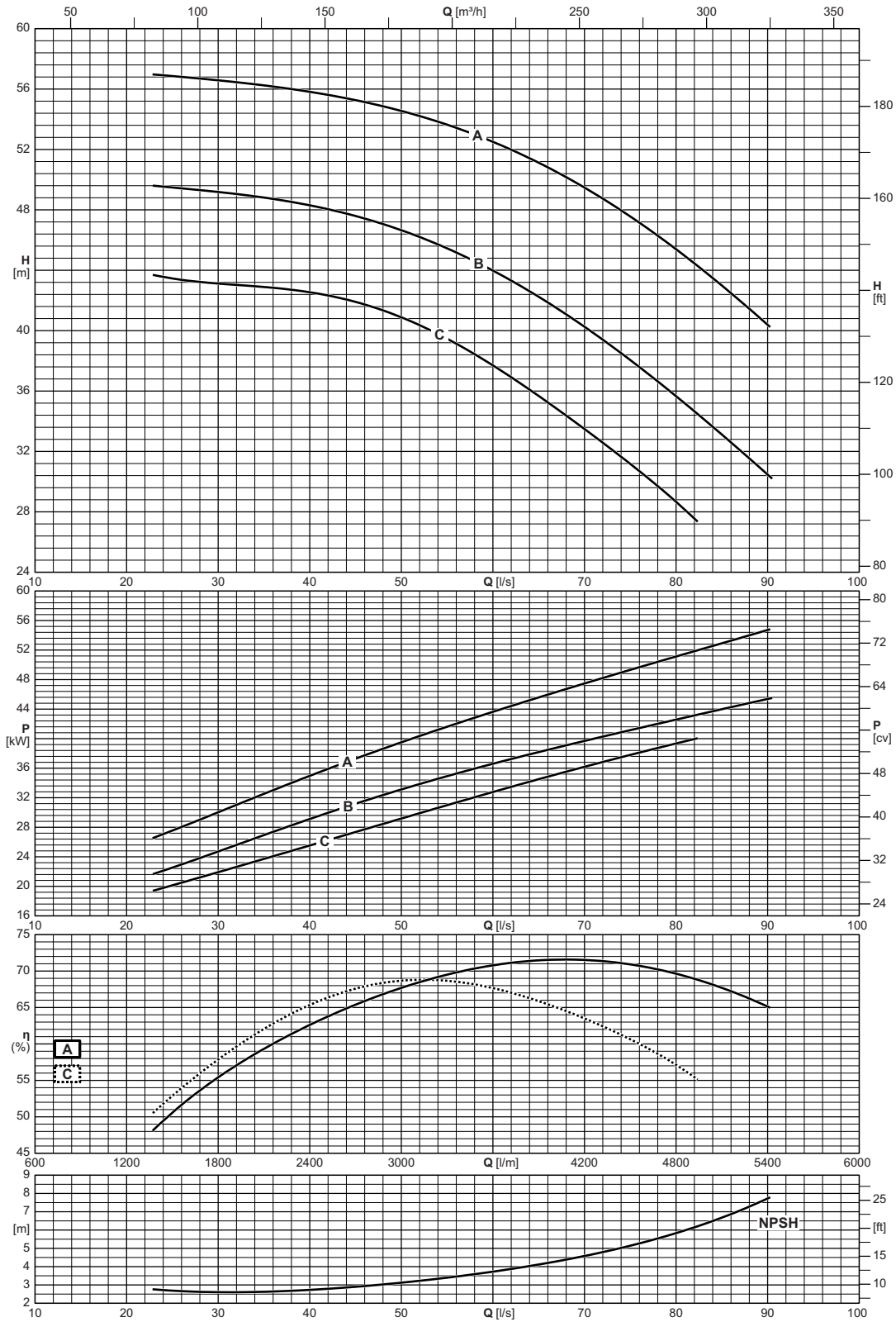

Type Type Tipo	Inlet maximum pressure Pression maximale en aspiration Pressione massima in aspirazione
NCDS4P125-400	[bar] 10

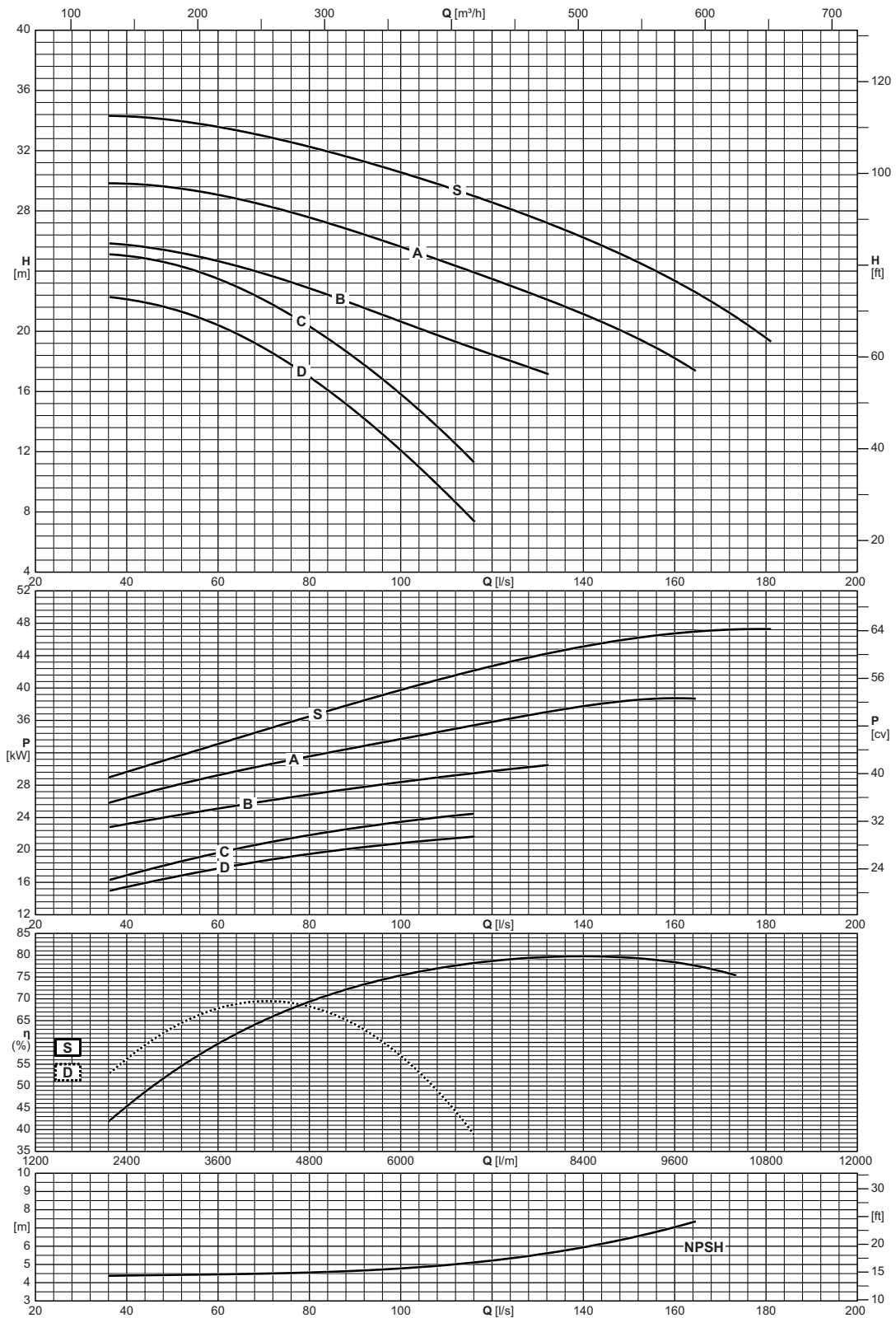

Type Type Tipo	Inlet maximum pressure Pression maximale en aspiration Pressione massima in aspirazione
NCDS4P150-315	[bar] 10

NCDS 4P150-400

1750 n [min⁻¹]



Operating data
 Caracteristiques de fonctionnement
 Caratteristiche di funzionamento

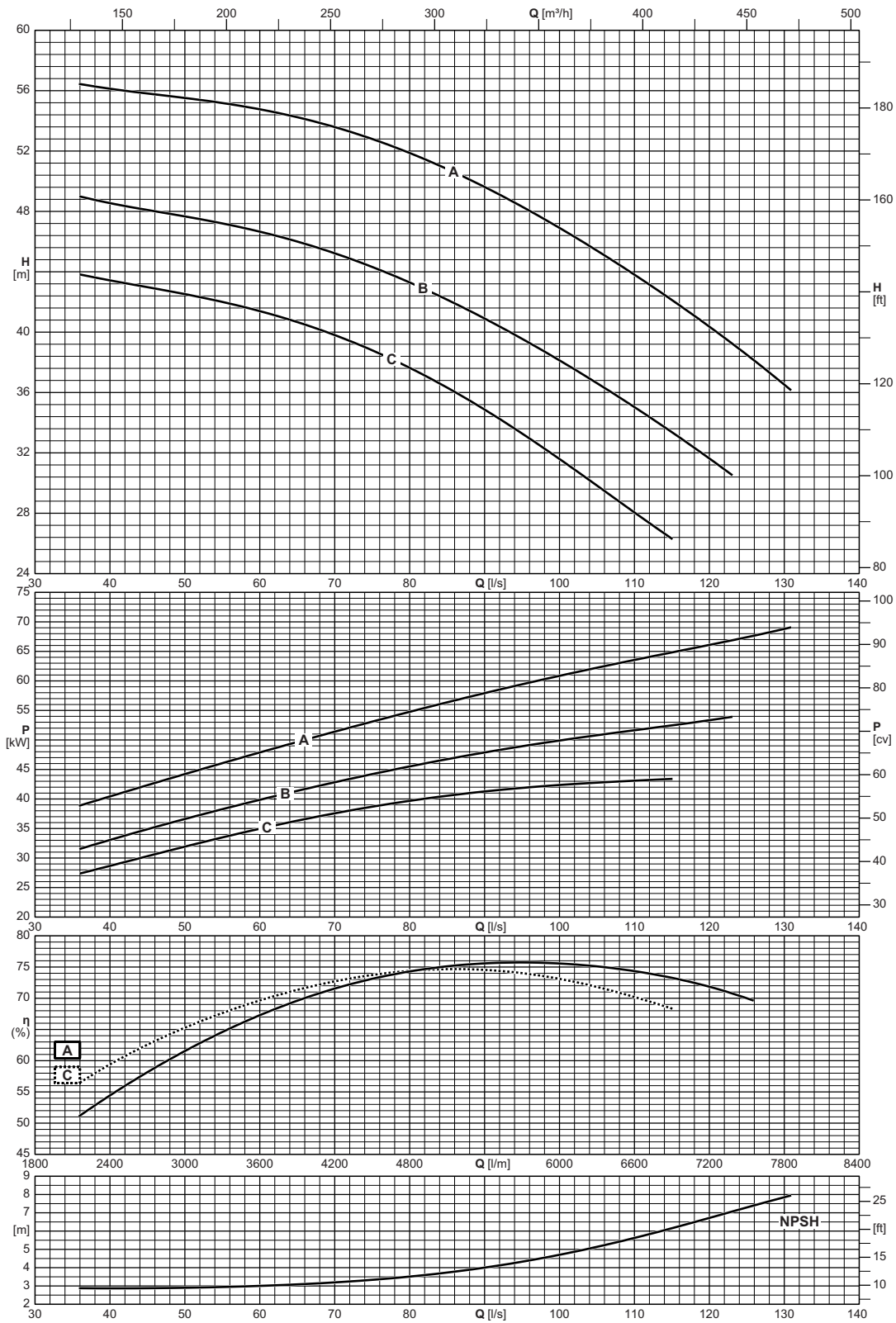

Type Type Tipo	Inlet maximum pressure Pression maximale en aspiration Pressione massima in aspirazione
NCDS4P150-400	[bar]
	10

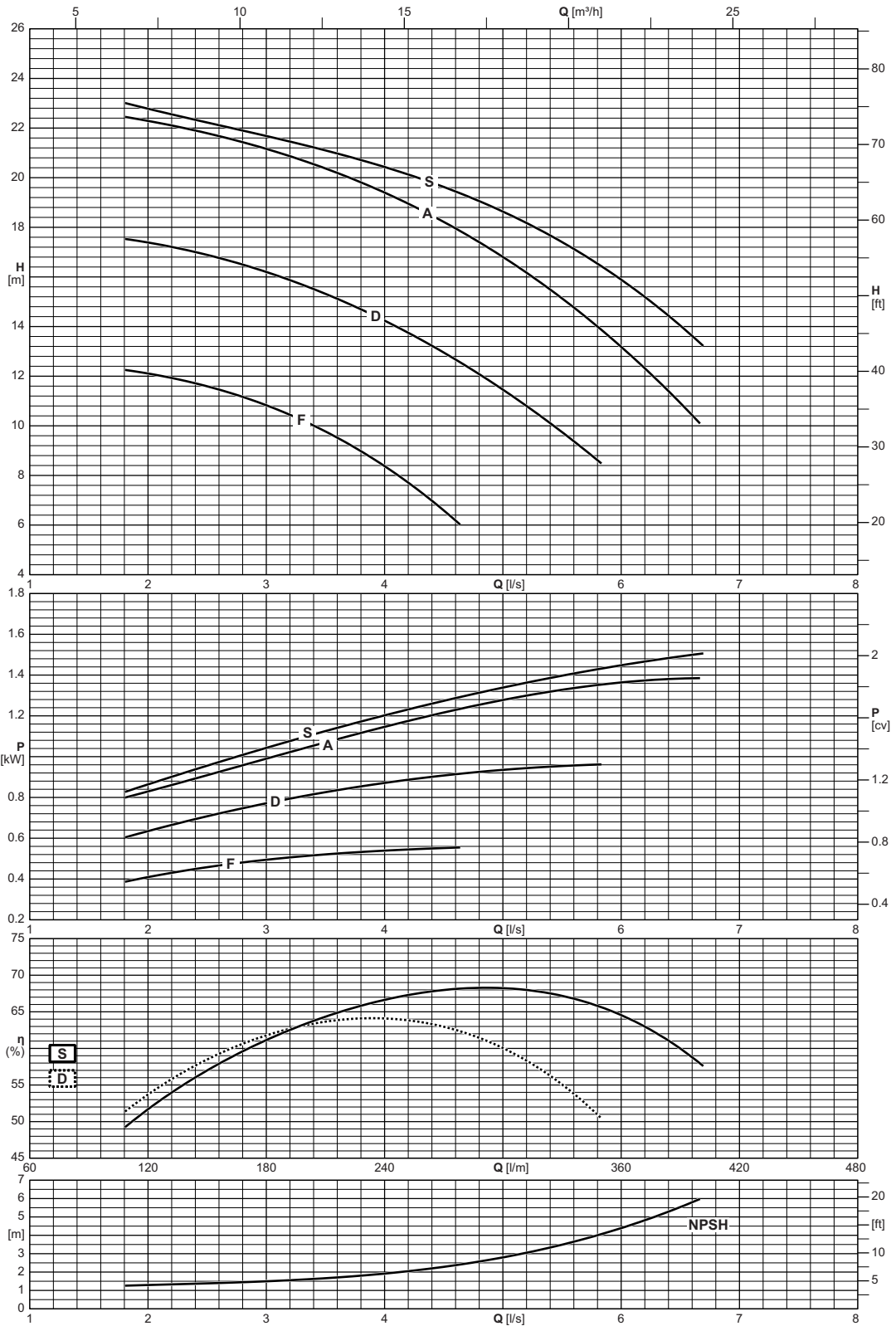

Type Type Tipo	Inlet maximum pressure Pression maximale en aspiration Pressione massima in aspirazione
NCD2P32-125	[bar] 10

NCD 2P32-160

2900 n [min⁻¹]



Operating data
Caracteristiques de fonctionnement
Caratteristiche di funzionamento

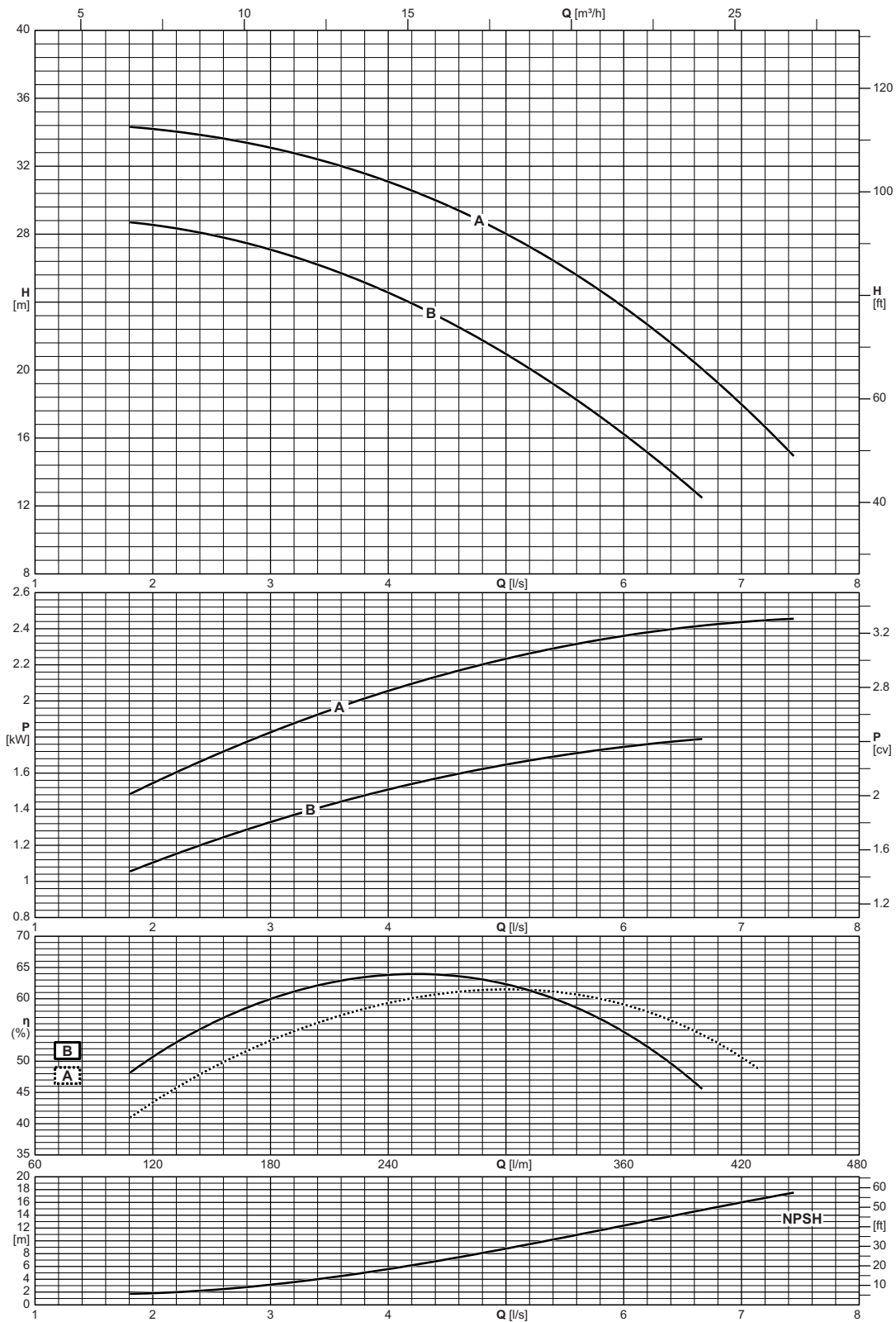

Type Type Tipo	Inlet maximum pressure Pression maximale en aspiration Pressione massima in aspirazione
NCD2P32-160	[bar] 10

Operating data
 Caracteristiques de fonctionnement
 Caratteristiche di funzionamento

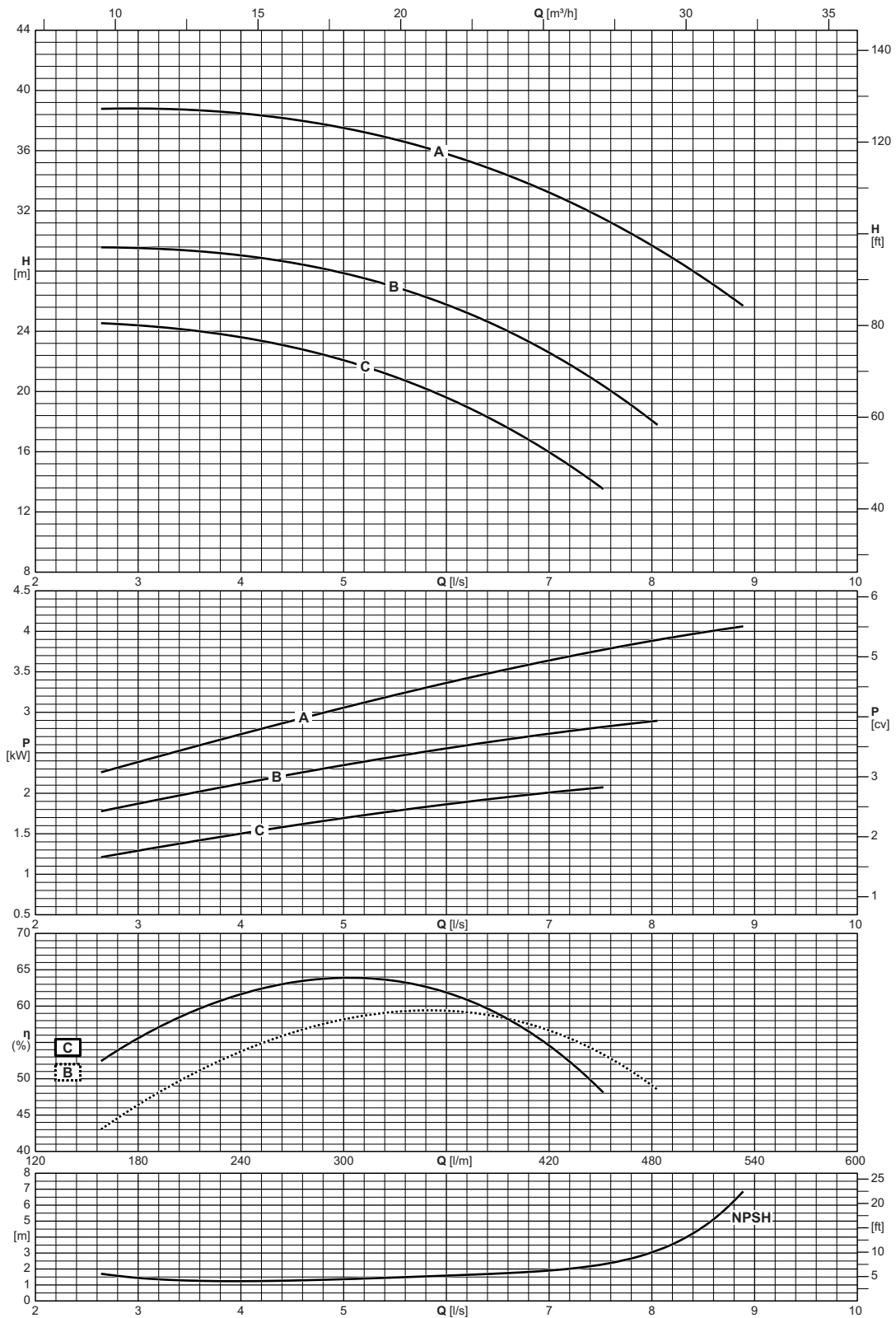

Type Type Tipo	Inlet maximum pressure Pression maximale en aspiration Pressione massima in aspirazione
NCD2P32L-160	[bar] 10

NCD 2P32L-200

2900 n [min⁻¹]



Operating data
 Caracteristiques de fonctionnement
 Caratteristiche di funzionamento

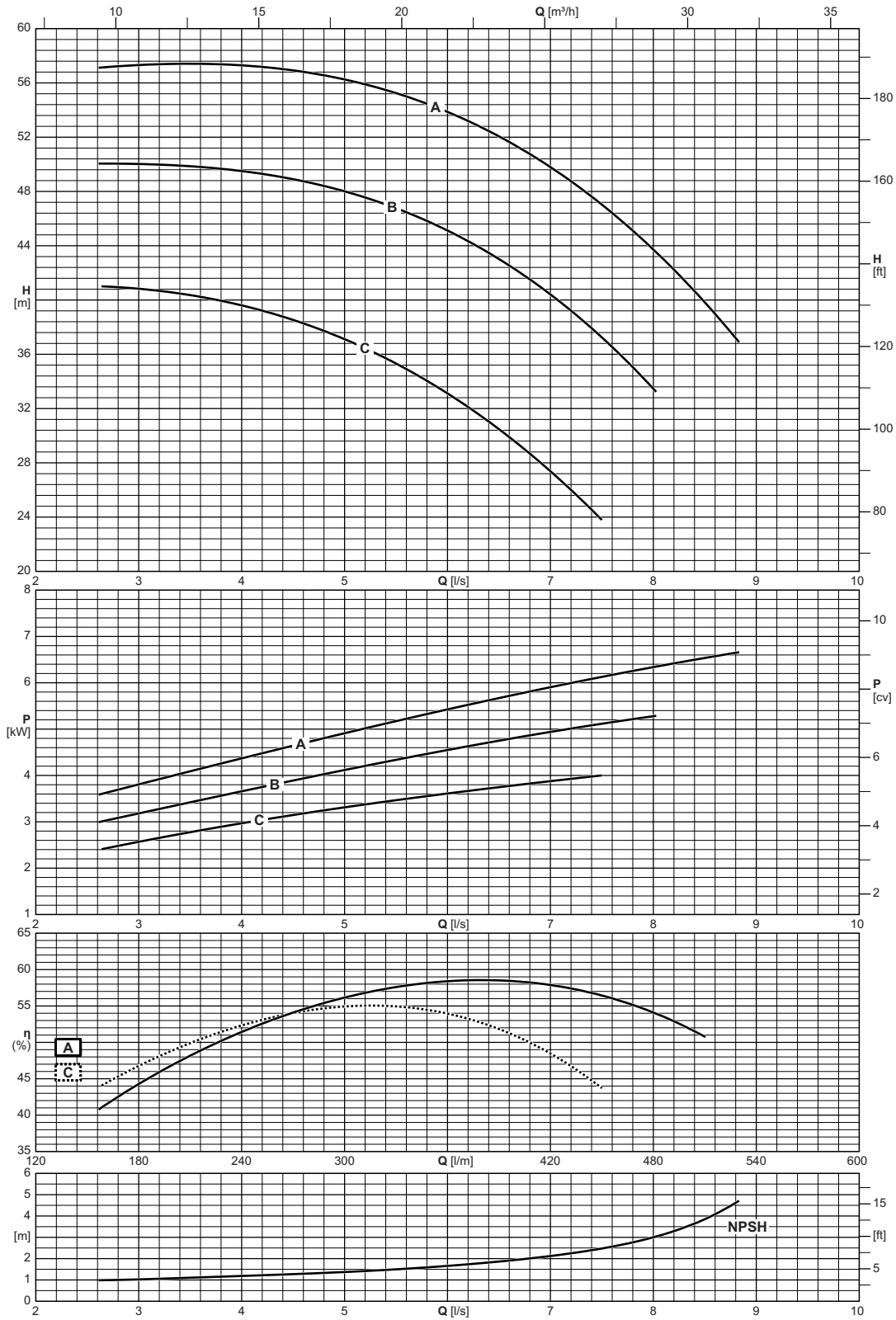

Type Type Tipo	Inlet maximum pressure Pression maximale en aspiration Pressione massima in aspirazione
NCD2P32L-200	[bar] 10

Operating data
 Caracteristiques de fonctionnement
 Caratteristiche di funzionamento

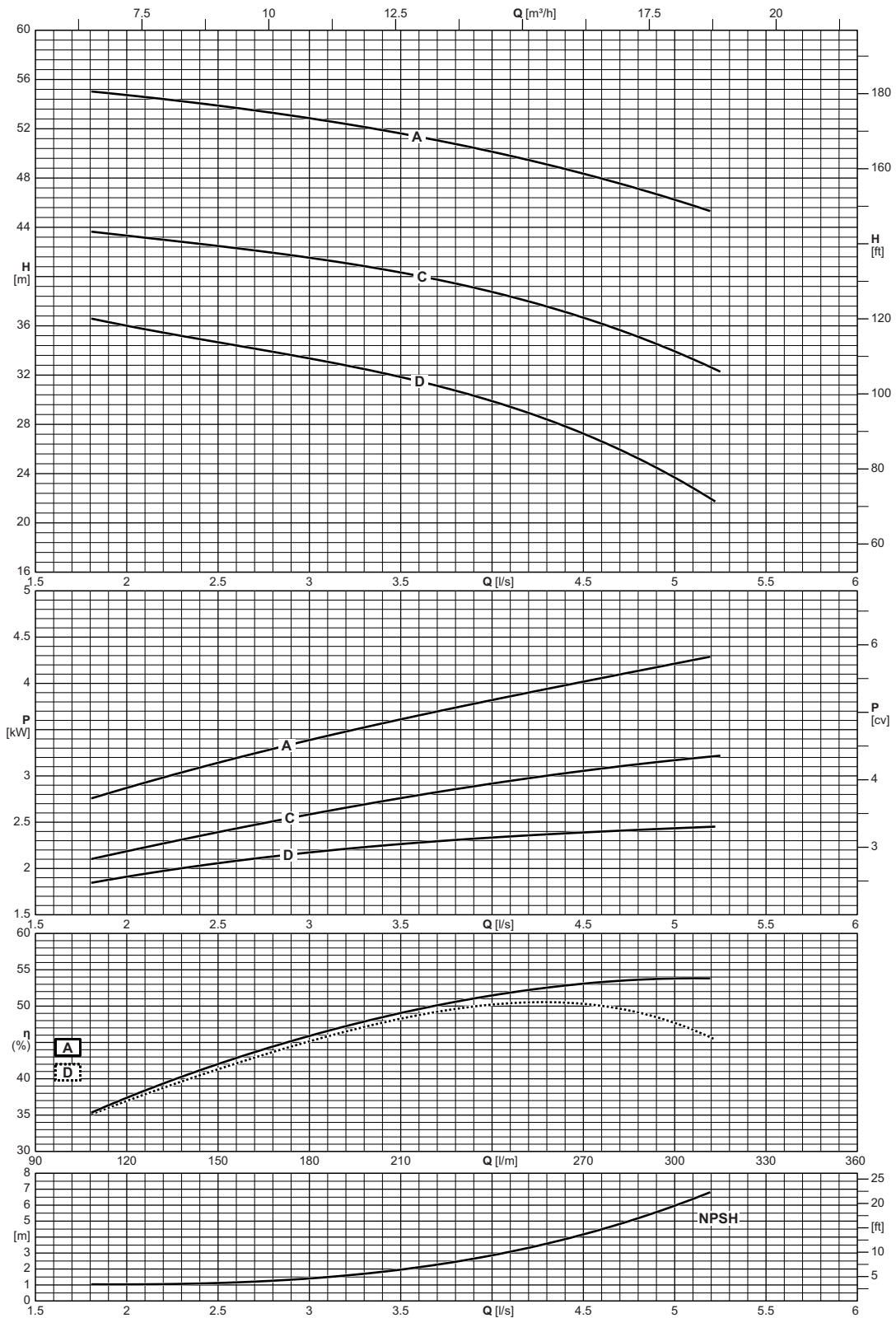

Type Type Tipo	Inlet maximum pressure Pression maximale en aspiration Pressione massima in aspirazione
NCD2P32-200	[bar] 10

NCD 2P40-125

2900 n [min⁻¹]



Operating data
Caracteristiques de fonctionnement
Caratteristiche di funzionamento

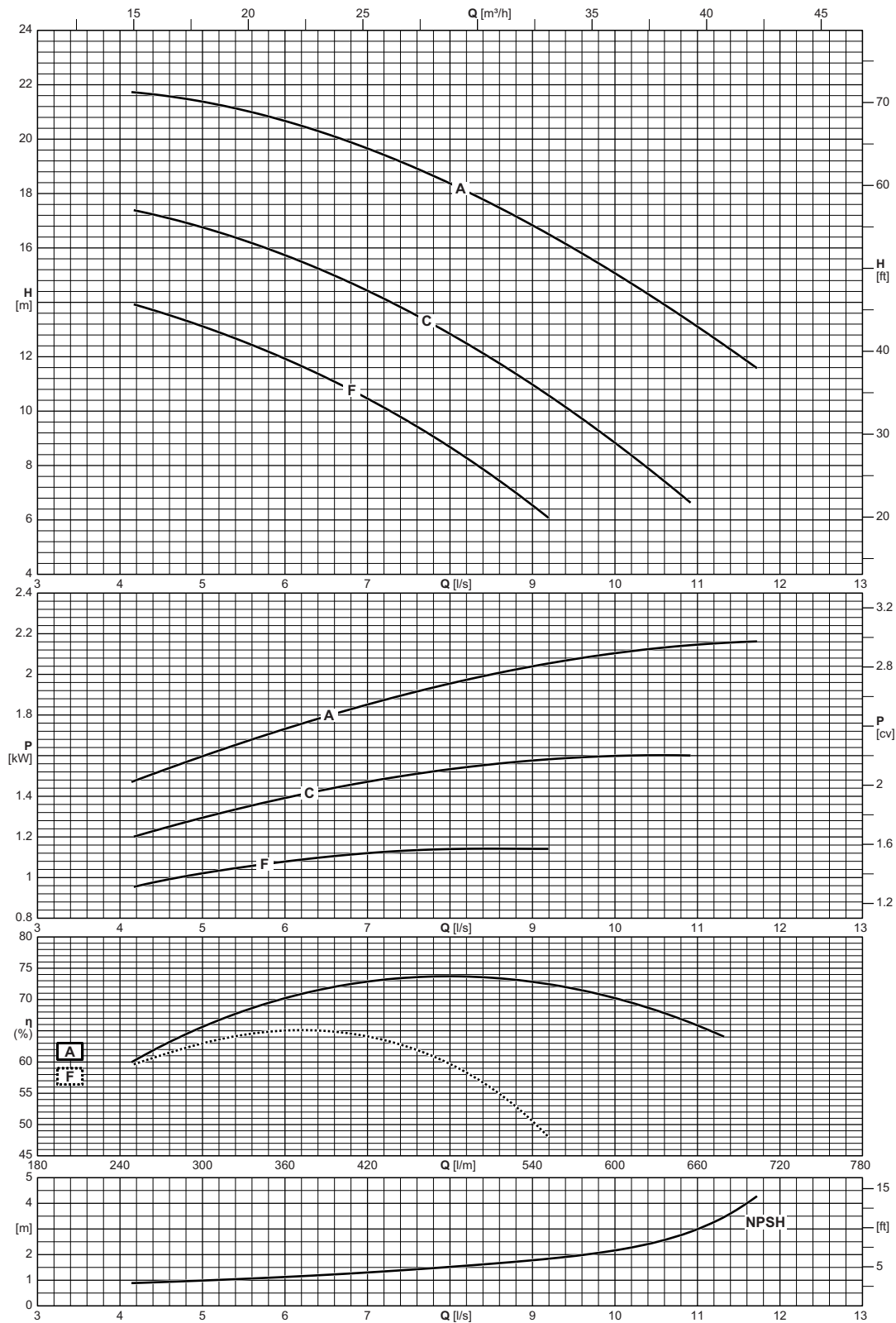

Type Type Tipo	Inlet maximum pressure Pression maximale en aspiration Pressione massima in aspirazione
NCD2P40-125	[bar] 10

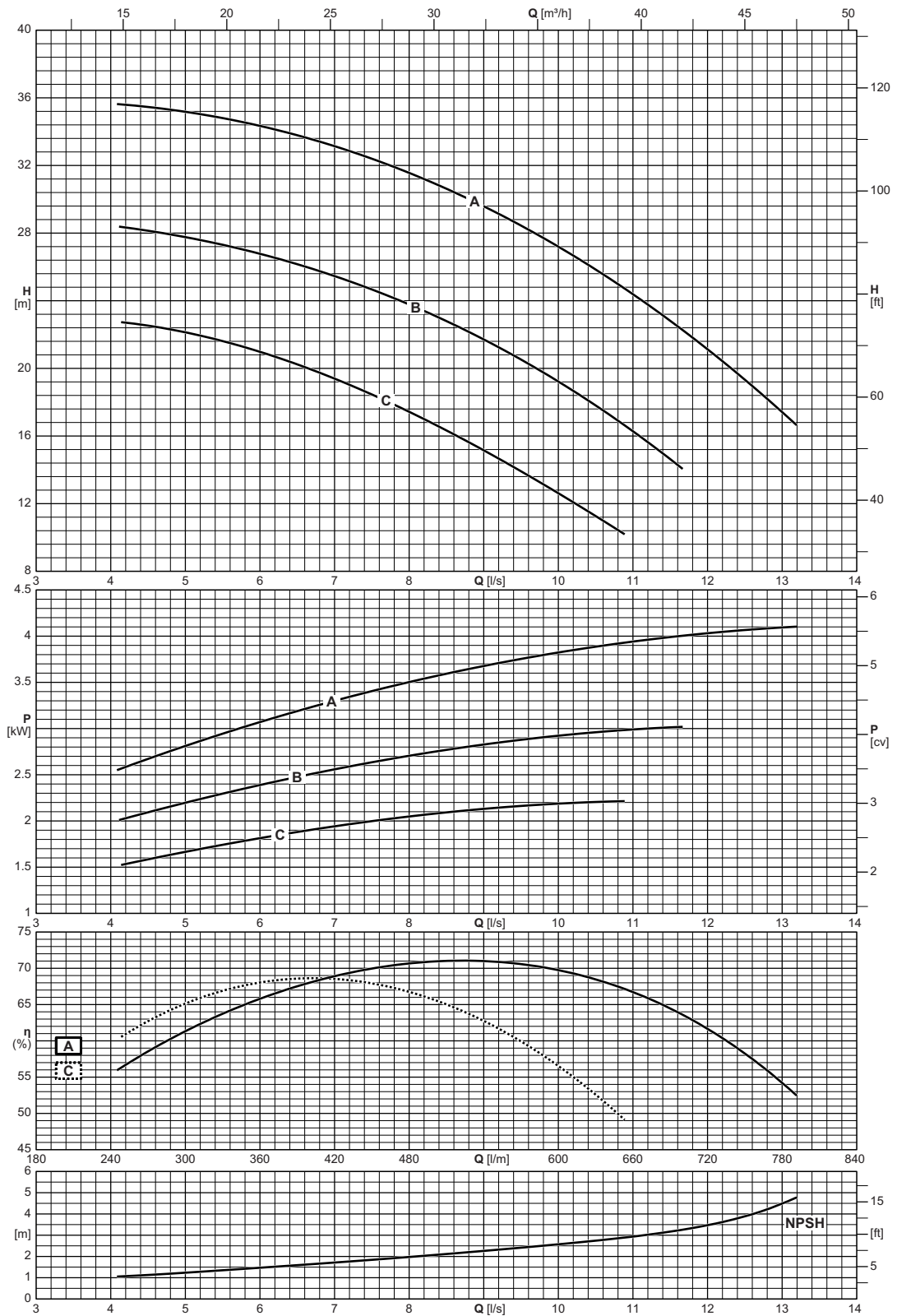

Type Type Tipo	Inlet maximum pressure Pression maximale en aspiration Pressione massima in aspirazione
	[bar]
NCD2P40-160	10

NCD 2P40-200

2900 n [min⁻¹]



Operating data
Caracteristiques de fonctionnement
Caratteristiche di funzionamento

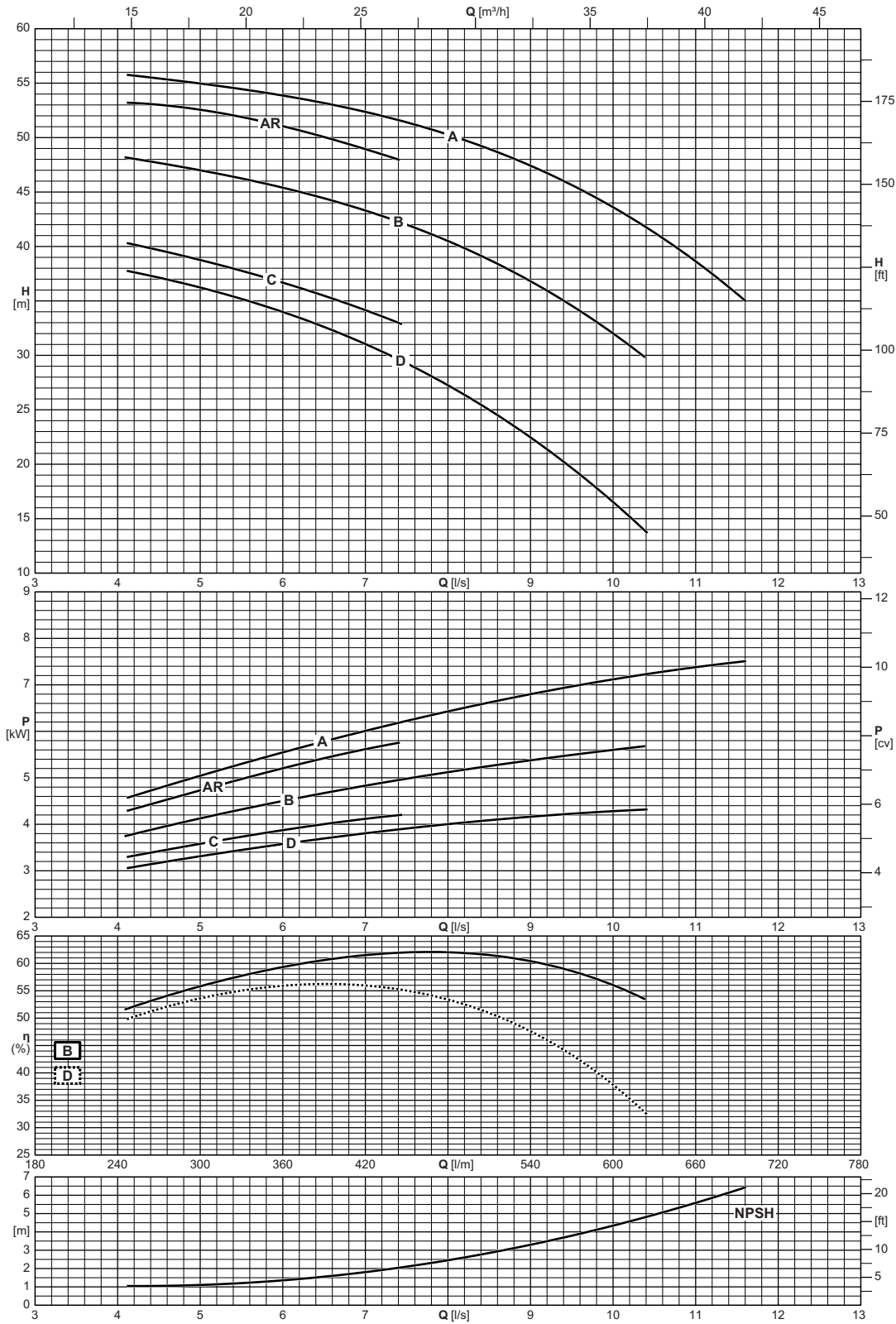

Type Type Tipo	Inlet maximum pressure Pression maximale en aspiration Pressione massima in aspirazione
NCD2P40-200	[bar] 10

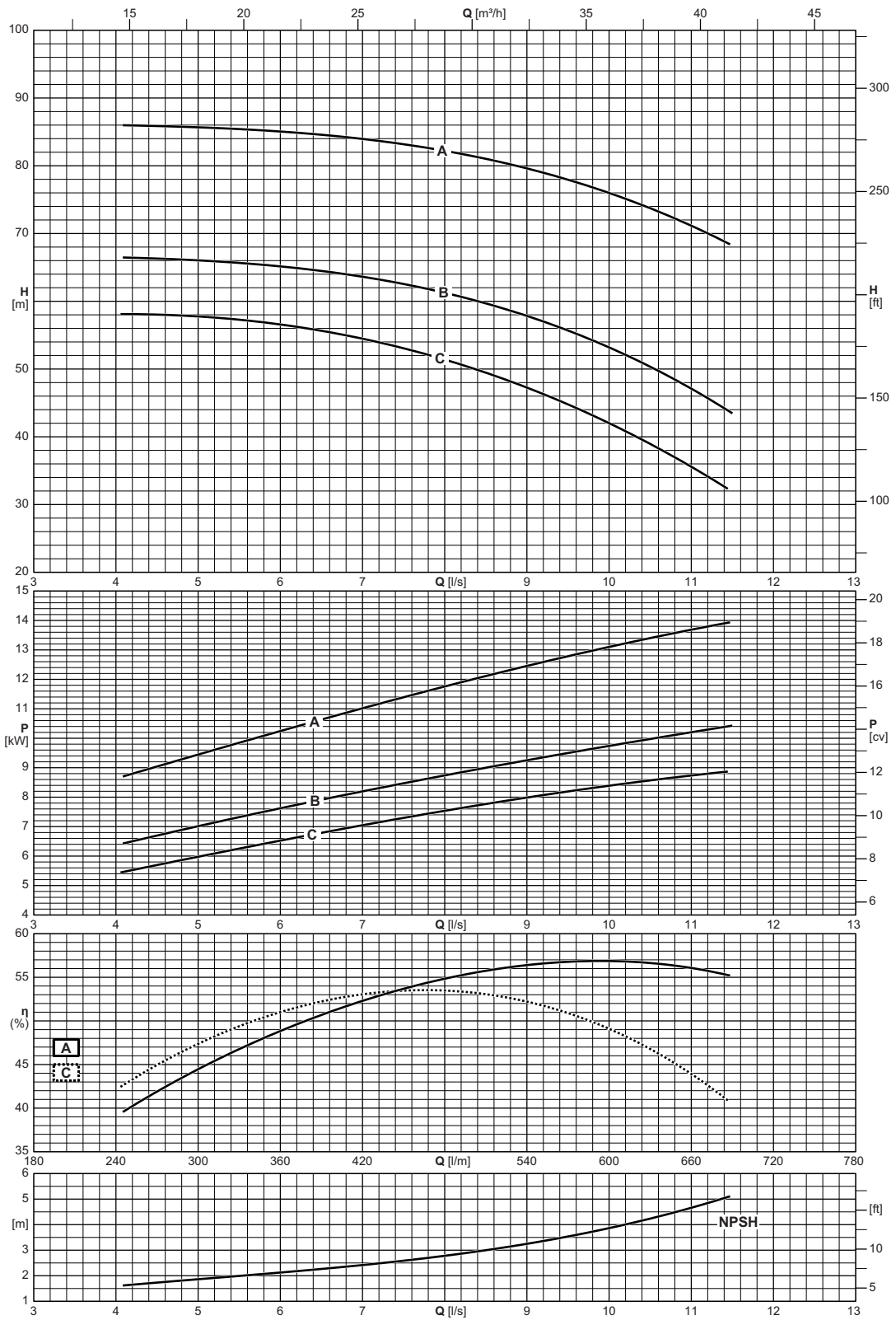

Type Type Tipo	Inlet maximum pressure Pression maximale en aspiration Pressione massima in aspirazione
NCD2P40-250	[bar] 10

NCD 2P50-125

2900 n [min⁻¹]



Operating data
 Caracteristiques de fonctionnement
 Caratteristiche di funzionamento

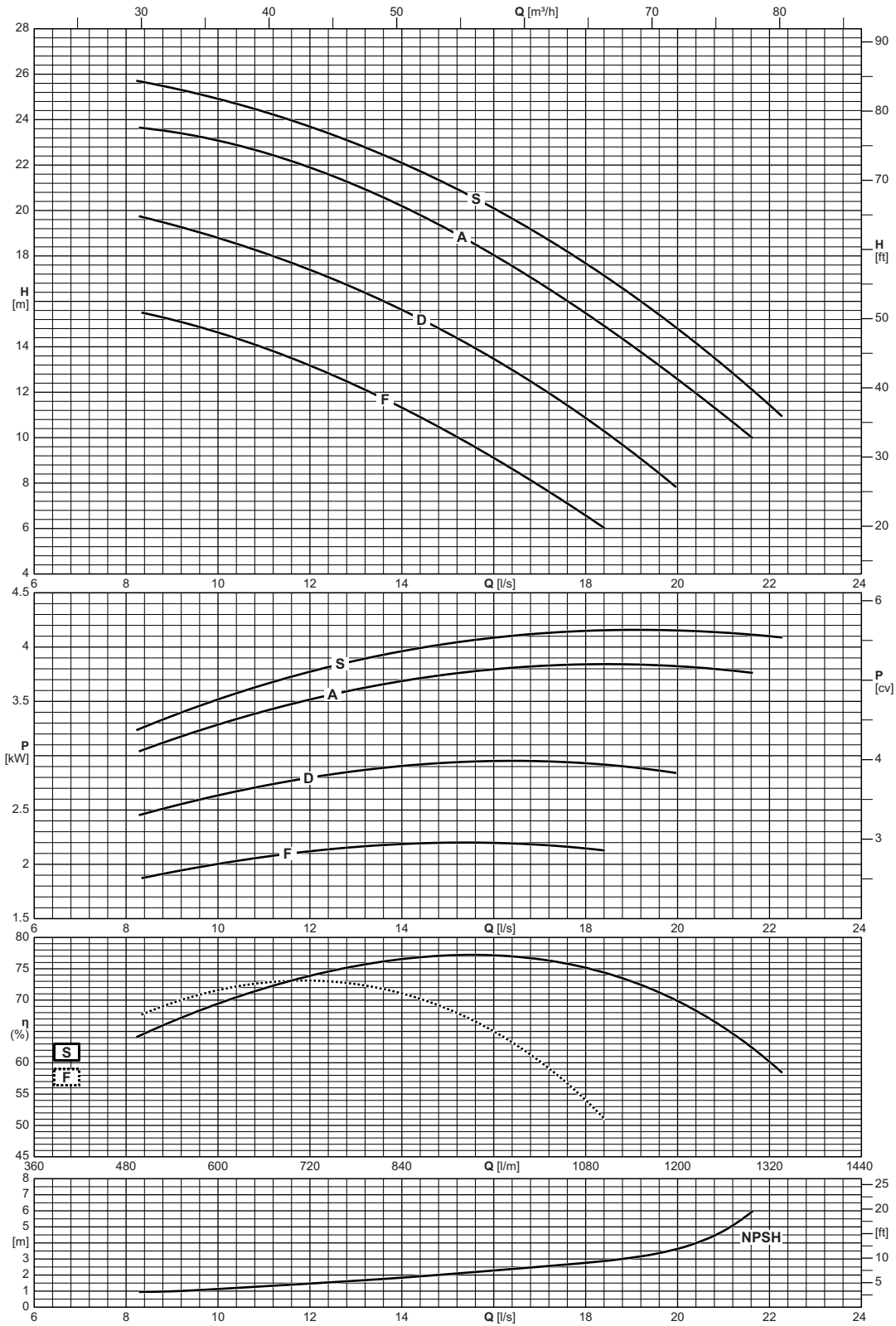

Type Type Tipo	Inlet maximum pressure Pression maximale en aspiration Pressione massima in aspirazione
NCD2P50-125	[bar] 10

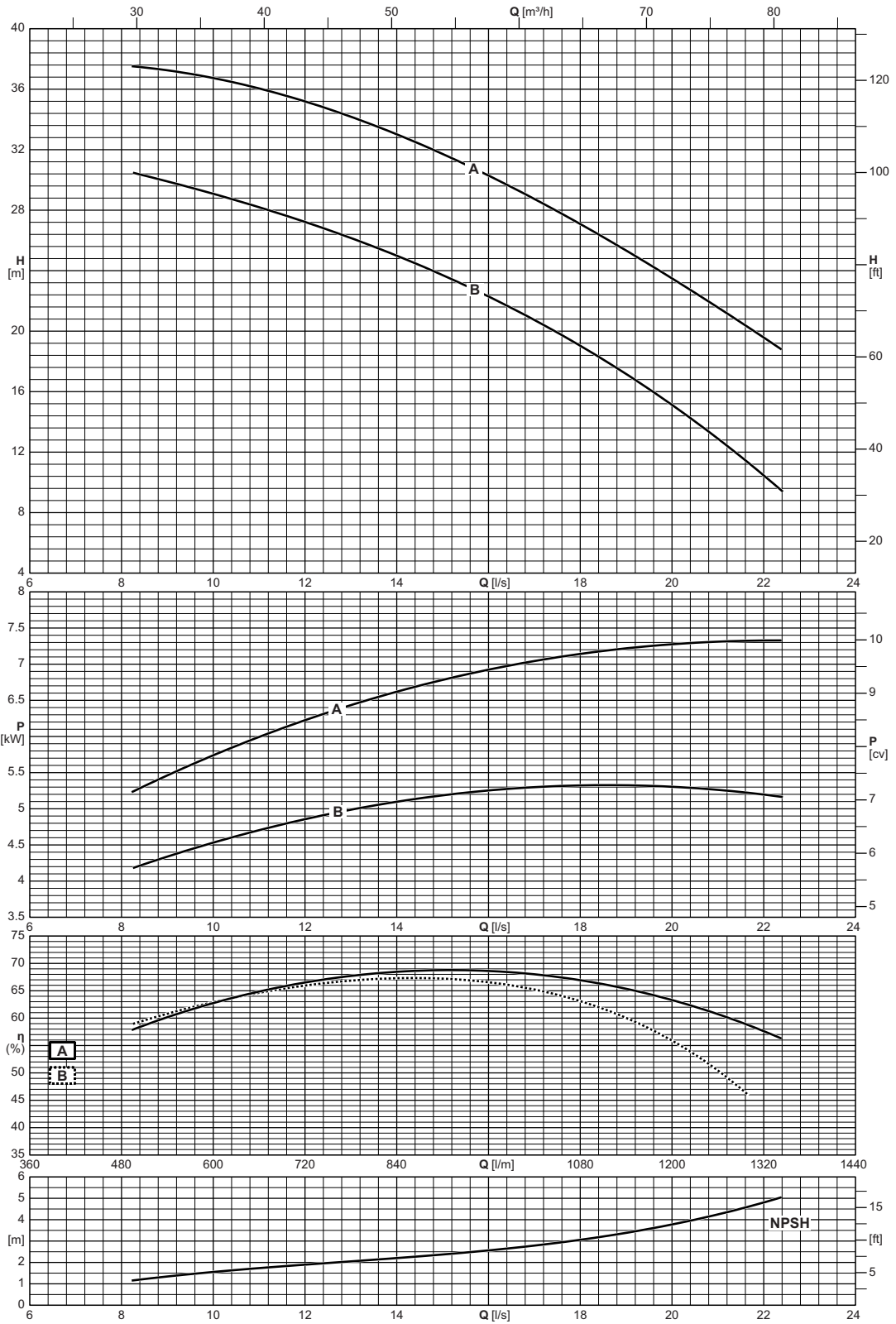

Type Type Tipo	Inlet maximum pressure Pression maximale en aspiration Pressione massima in aspirazione
NCD2P50-160	[bar] 10

NCD 2P50-200

2900 n [min⁻¹]



Operating data
 Caracteristiques de fonctionnement
 Caratteristiche di funzionamento

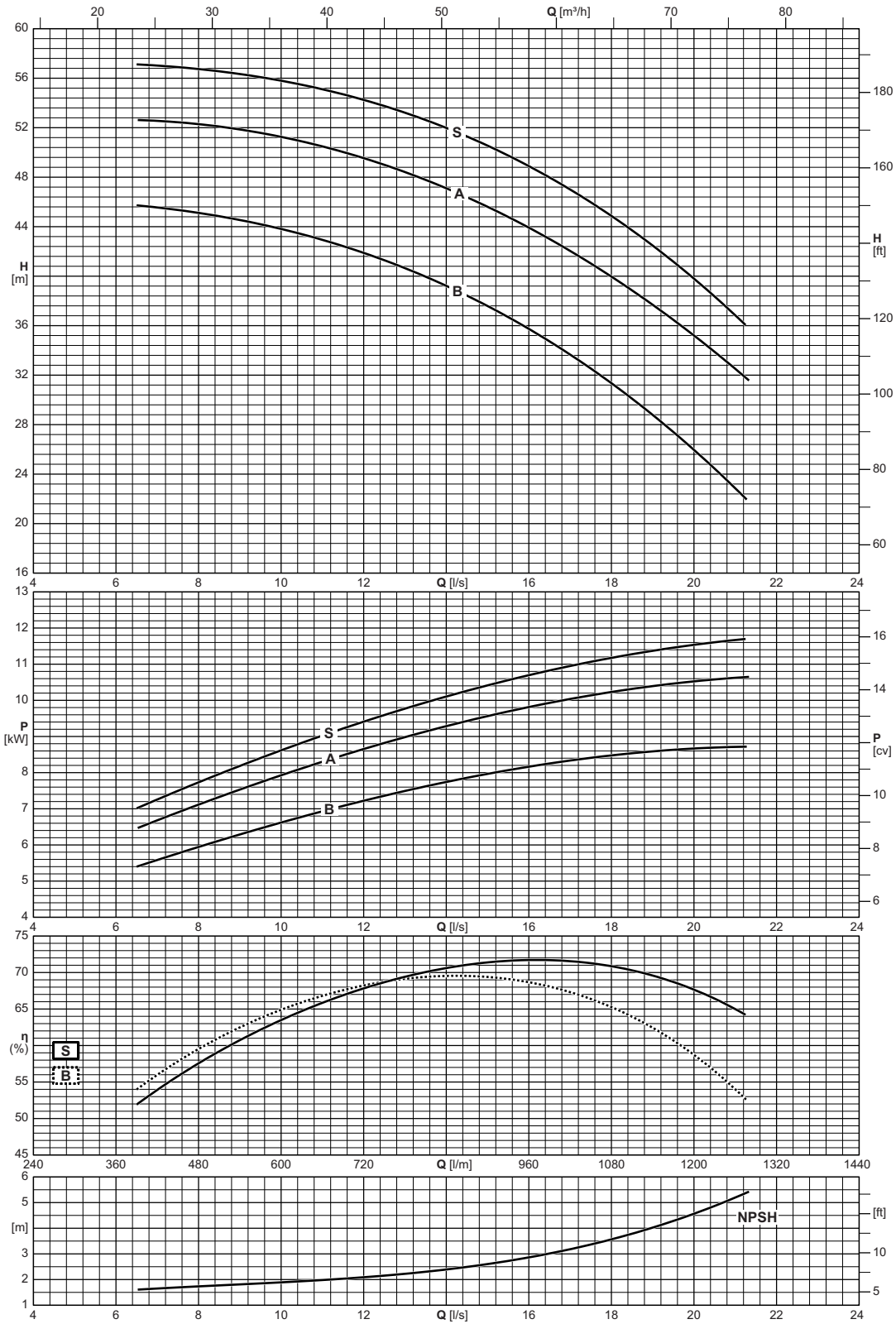

Type Type Tipo	Inlet maximum pressure Pression maximale en aspiration Pressione massima in aspirazione
NCD2P50-200	[bar] 10

Operating data
 Caracteristiques de fonctionnement
 Caratteristiche di funzionamento

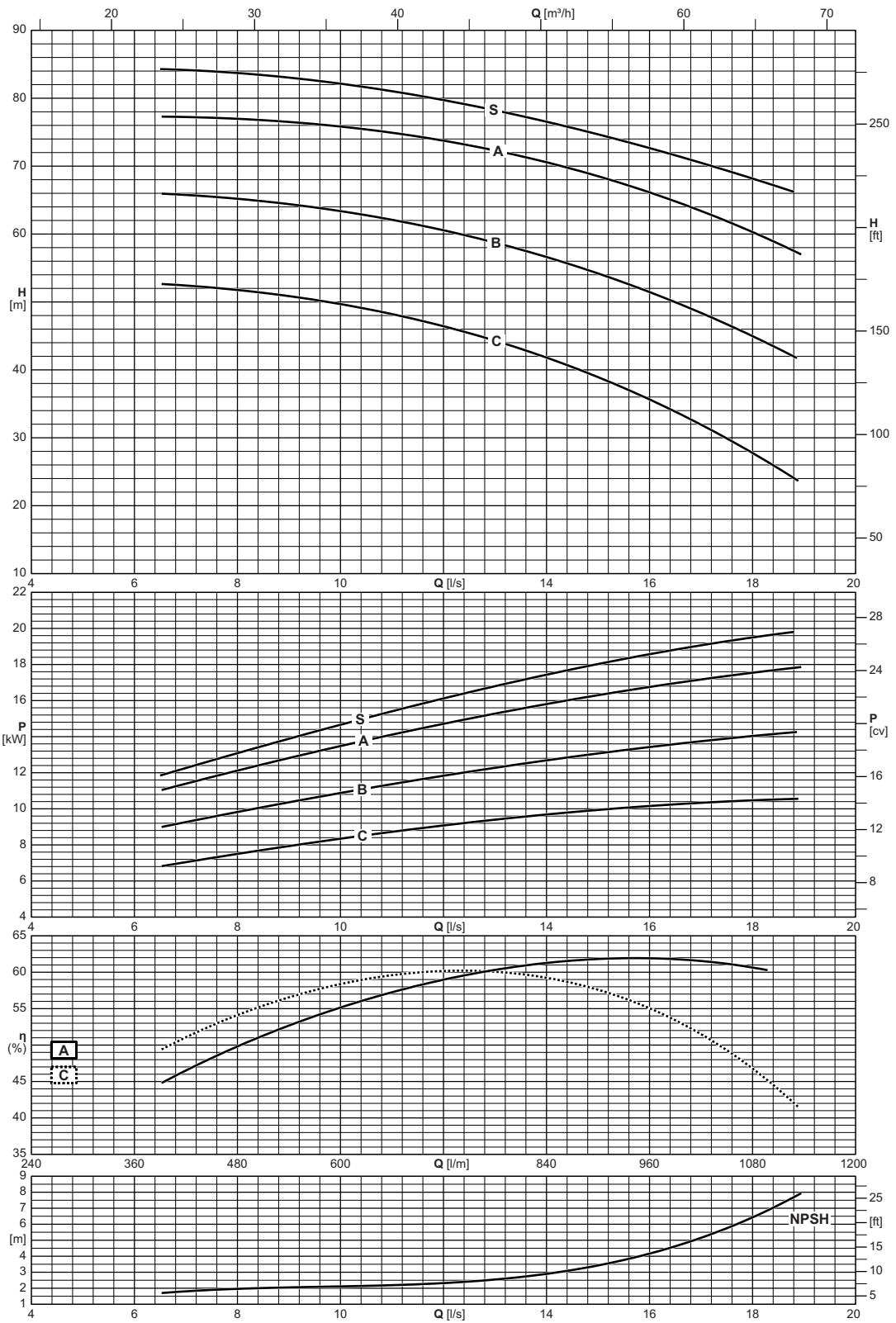

Type Type Tipo	Inlet maximum pressure Pression maximale en aspiration Pressione massima in aspirazione
NCD2P50-250	[bar] 10

NCD 2P65-125

2900 n [min⁻¹]



Operating data
Caracteristiques de fonctionnement
Caratteristiche di funzionamento

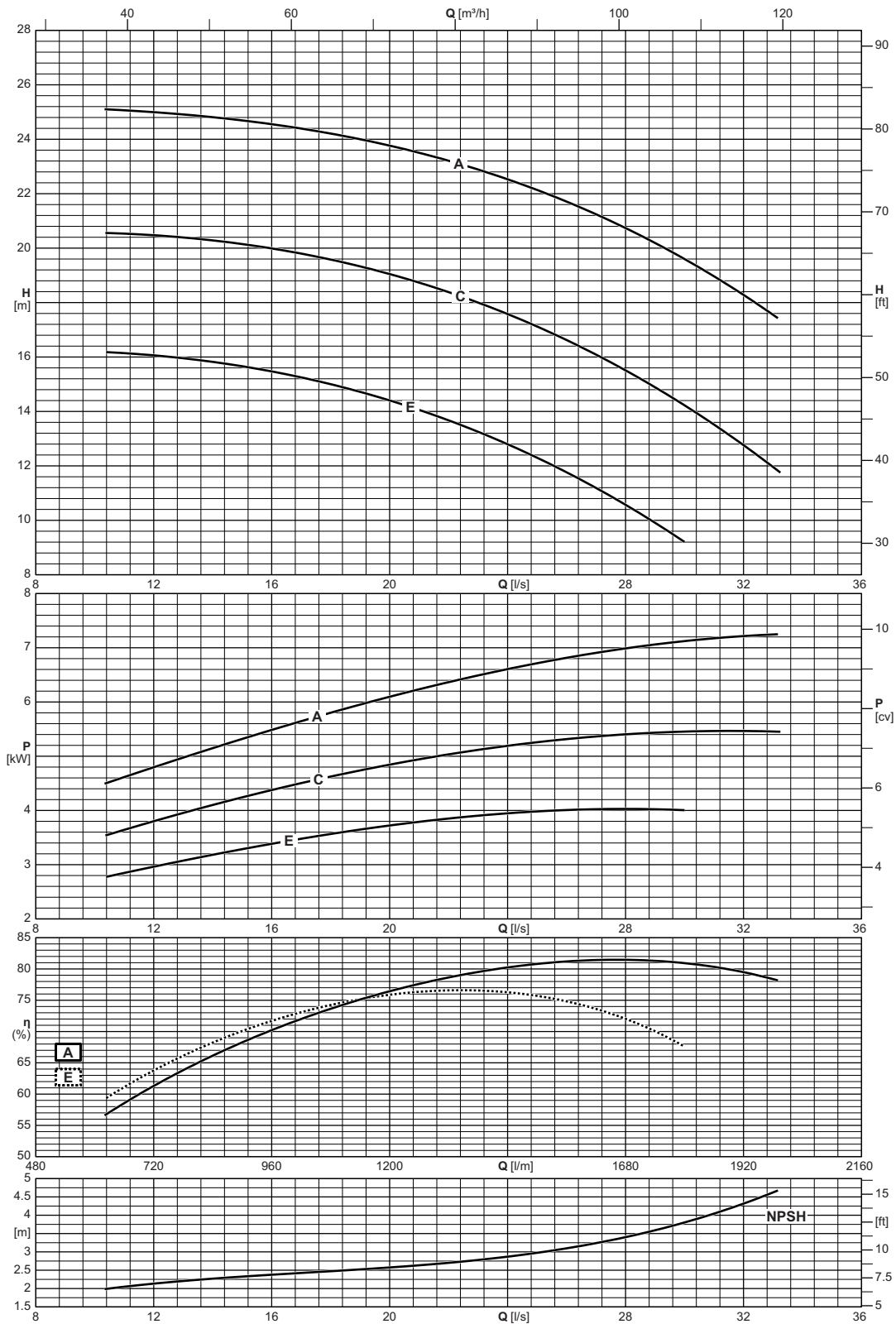

Type Type Tipo	Inlet maximum pressure Pression maximale en aspiration Pressione massima in aspirazione
NCD2P65-125	[bar] 10

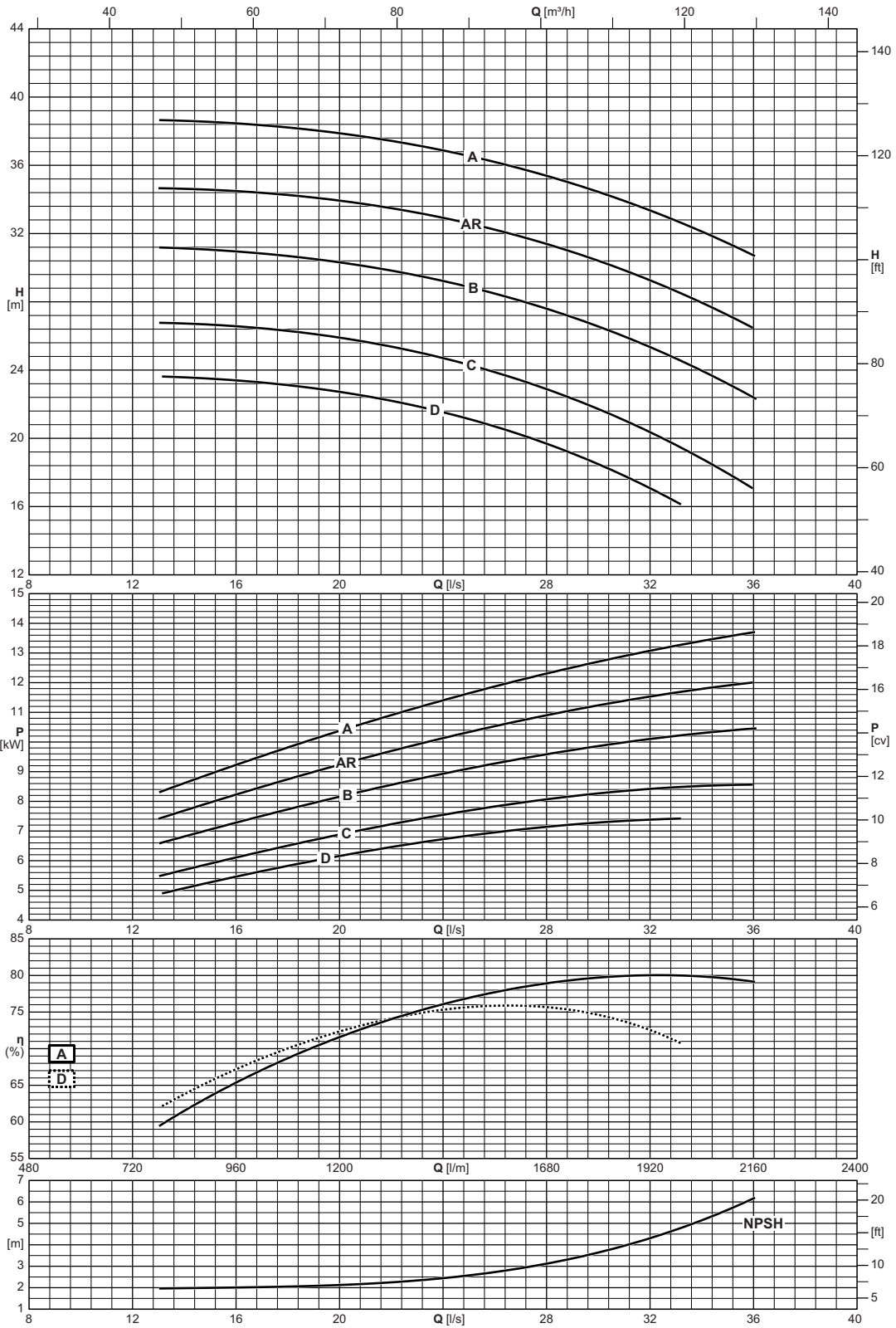

Type Type Tipo	Inlet maximum pressure Pression maximale en aspiration Pressione massima in aspirazione
NCD2P65-160	[bar] 10

NCD 2P65-200

2900 n [min⁻¹]



Operating data
Caracteristiques de fonctionnement
Caratteristiche di funzionamento

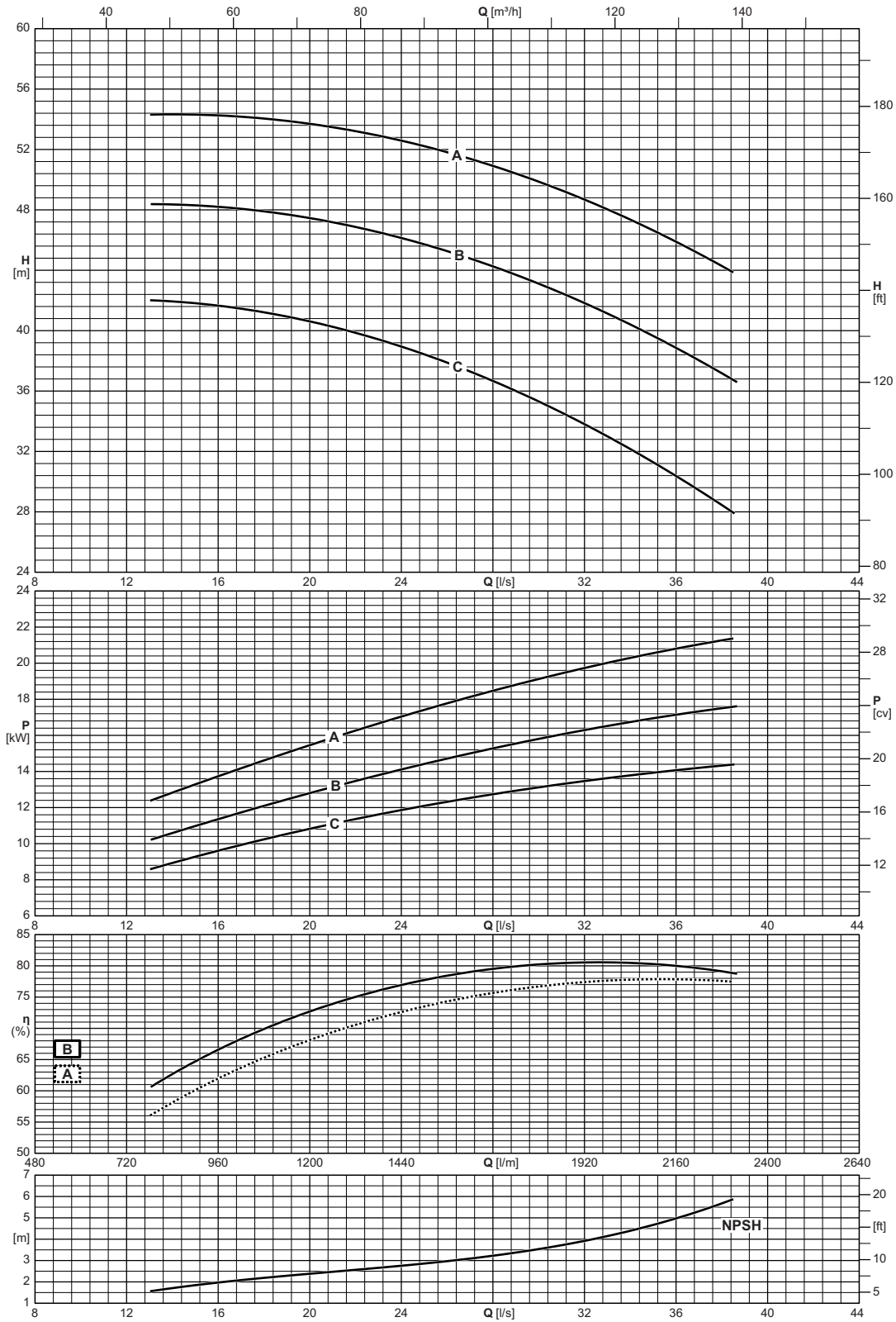

Type Type Tipo	Inlet maximum pressure Pression maximale en aspiration Pressione massima in aspirazione
NCD2P65-200	[bar] 10

Operating data
 Caracteristiques de fonctionnement
 Caratteristiche di funzionamento

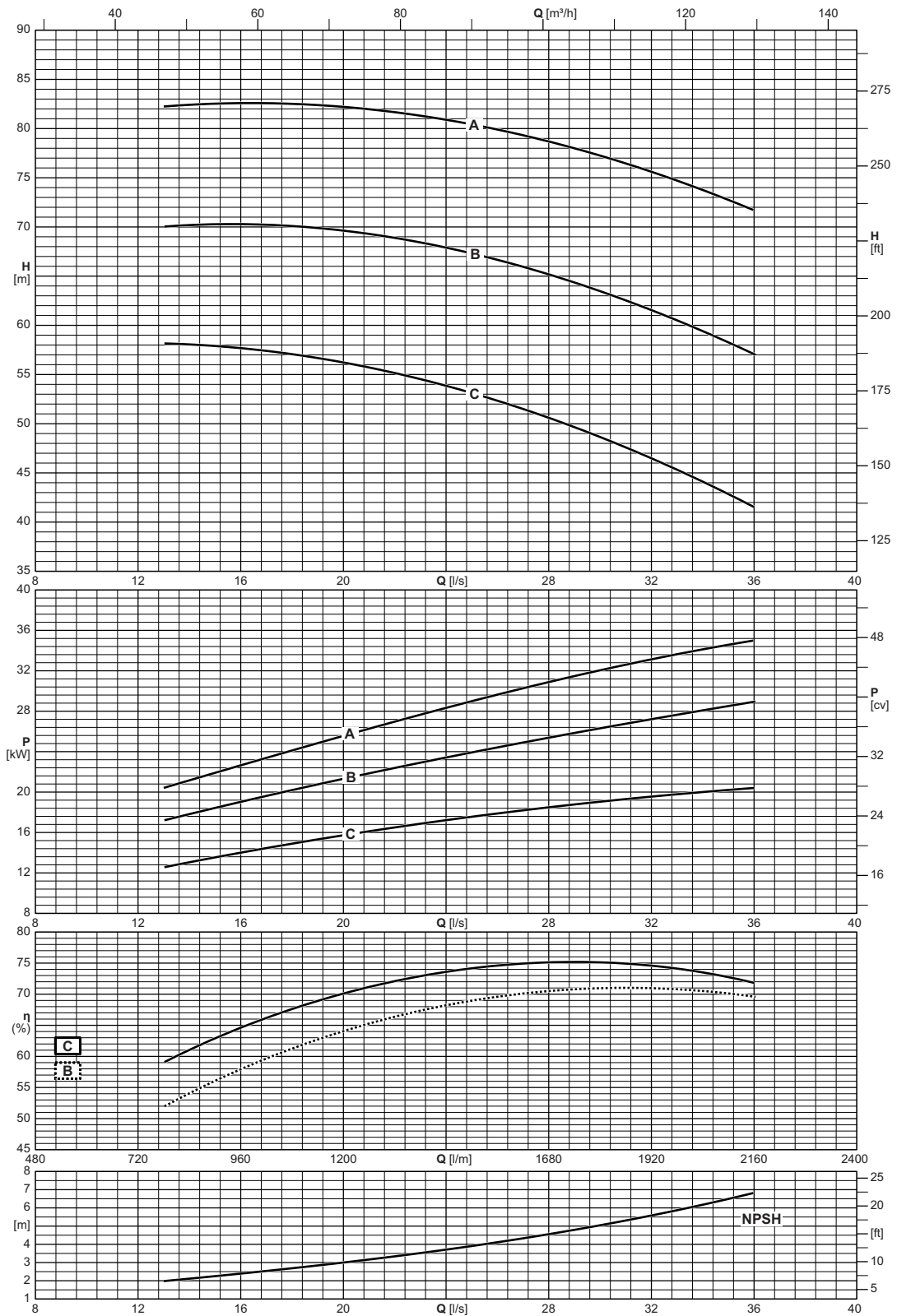

Type Type Tipo	Inlet maximum pressure Pression maximale en aspiration Pressione massima in aspirazione
NCD2P65-250	[bar] 10

NCD 2P80-160

2900 n [min⁻¹]



Operating data
Caracteristiques de fonctionnement
Caratteristiche di funzionamento

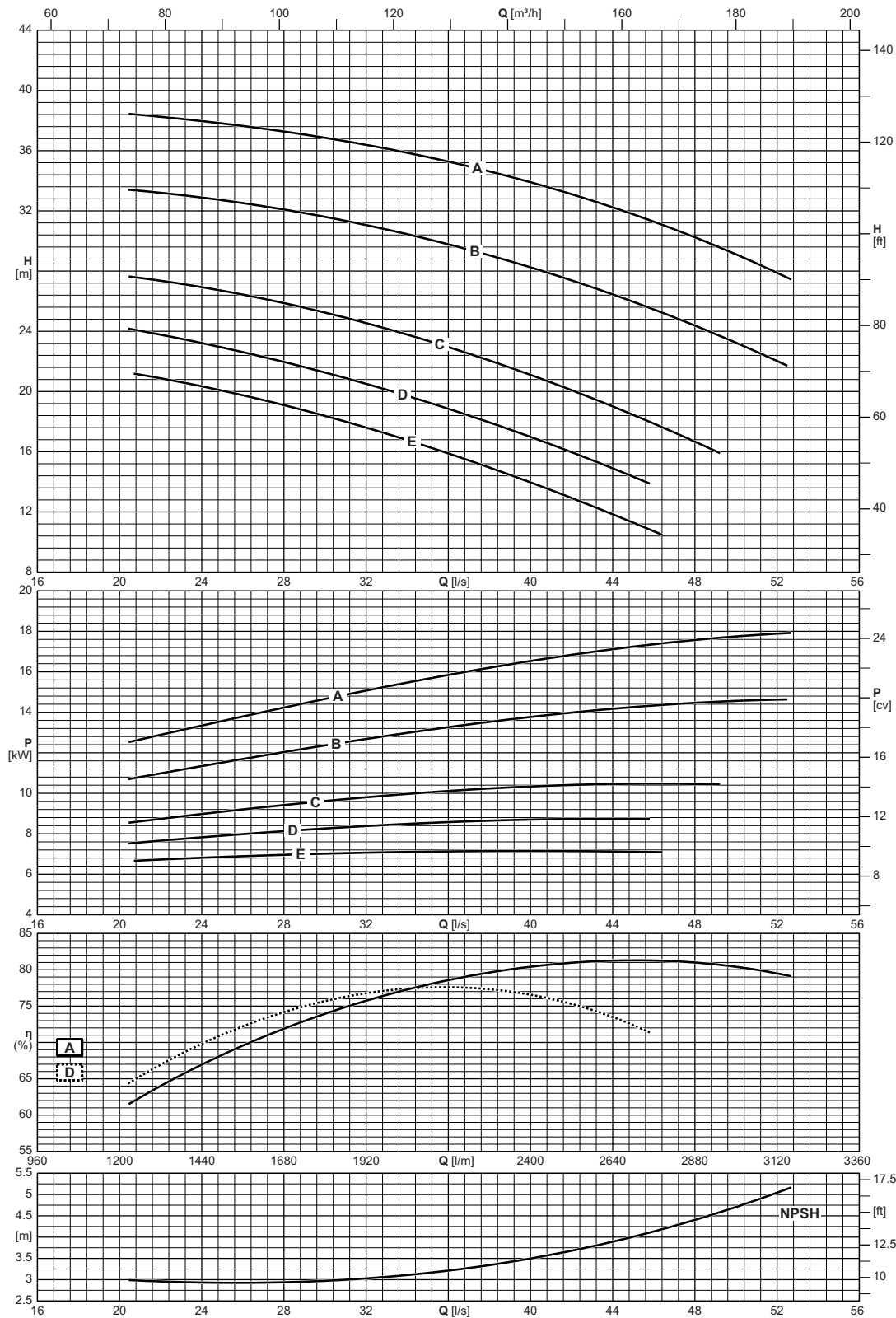

Type Type Tipo	Inlet maximum pressure Pression maximale en aspiration Pressione massima in aspirazione
NCD2P80-160	[bar] 10

Operating data
 Caracteristiques de fonctionnement
 Caratteristiche di funzionamento

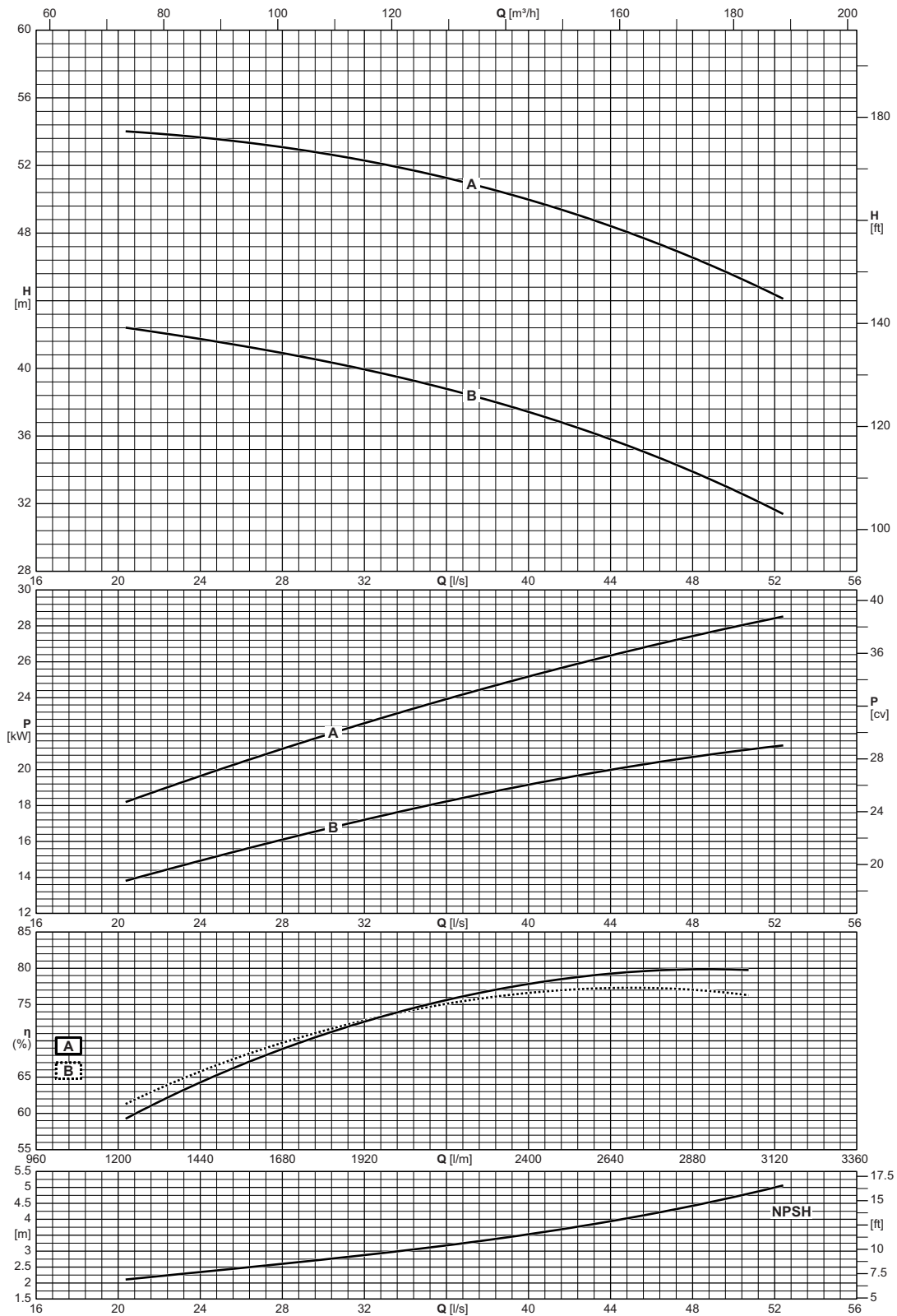

Type Type Tipo	Inlet maximum pressure Pression maximale en aspiration Pressione massima in aspirazione
NCD2P80-200	[bar] 10

NCD 2P80-250

2900 n [min⁻¹]



Operating data
Caracteristiques de fonctionnement
Caratteristiche di funzionamento

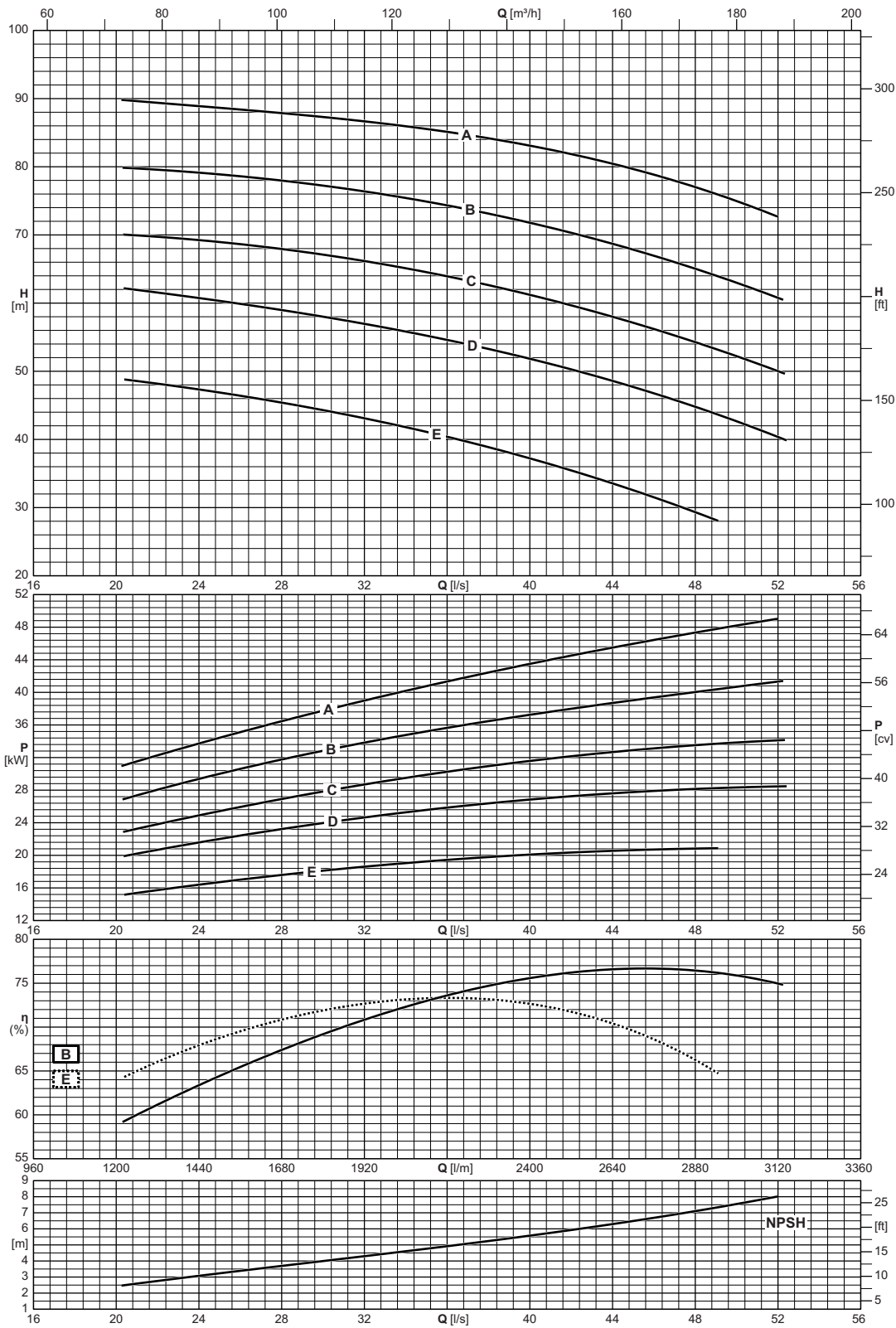

Type Type Tipo	Inlet maximum pressure Pression maximale en aspiration Pressione massima in aspirazione
NCD2P80-250	[bar] 10

Operating data
 Caracteristiques de fonctionnement
 Caratteristiche di funzionamento

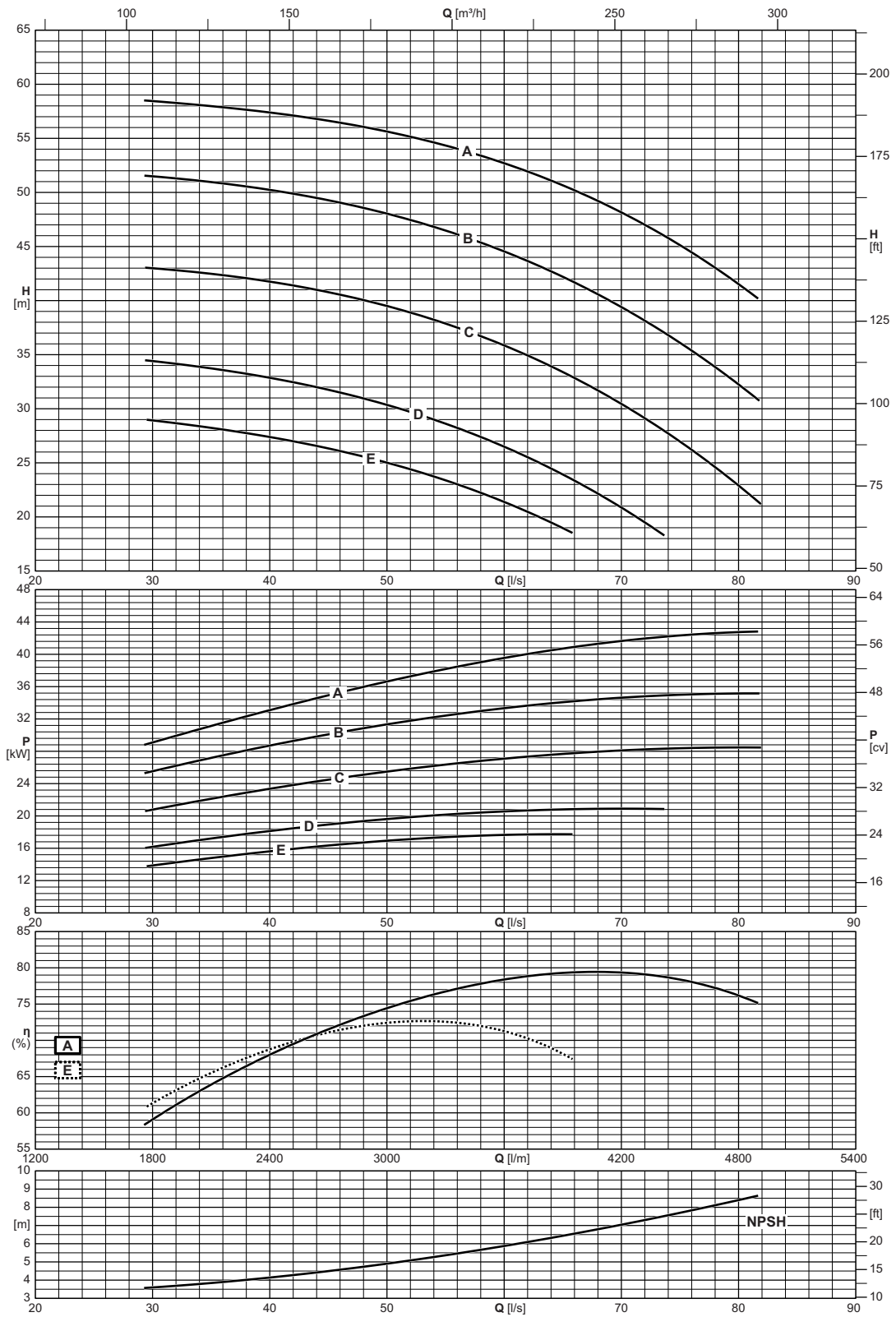

Type Type Tipo	Inlet maximum pressure Pression maximale en aspiration Pressione massima in aspirazione
NCD2P100-200	[bar] 10

NCD 2P100-250

2900 n [min⁻¹]



Operating data
Caracteristiques de fonctionnement
Caratteristiche di funzionamento

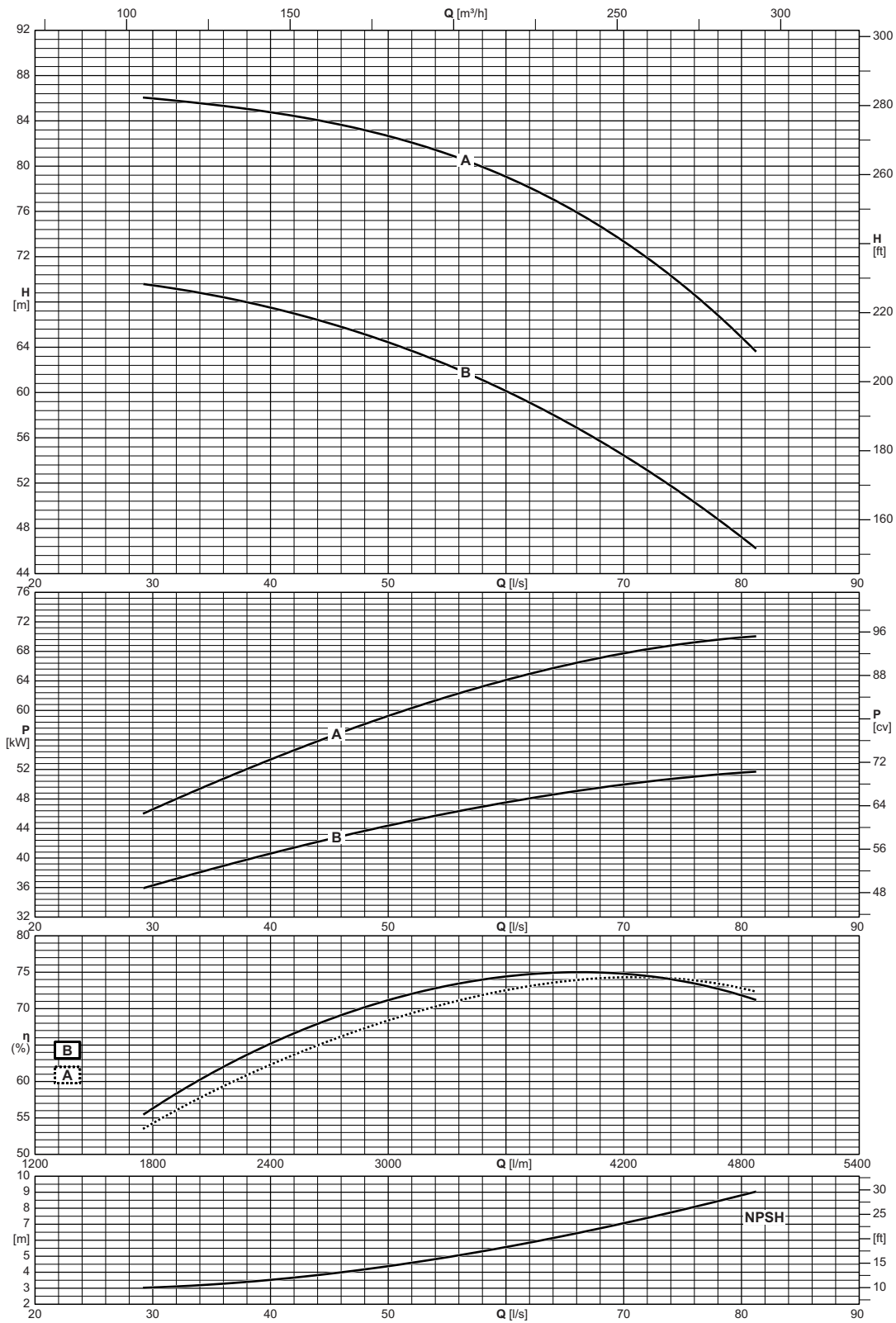

Type Type Tipo	Inlet maximum pressure Pression maximale en aspiration Pressione massima in aspirazione
NCD2P100-250	[bar] 10

Operating data
 Caracteristiques de fonctionnement
 Caratteristiche di funzionamento

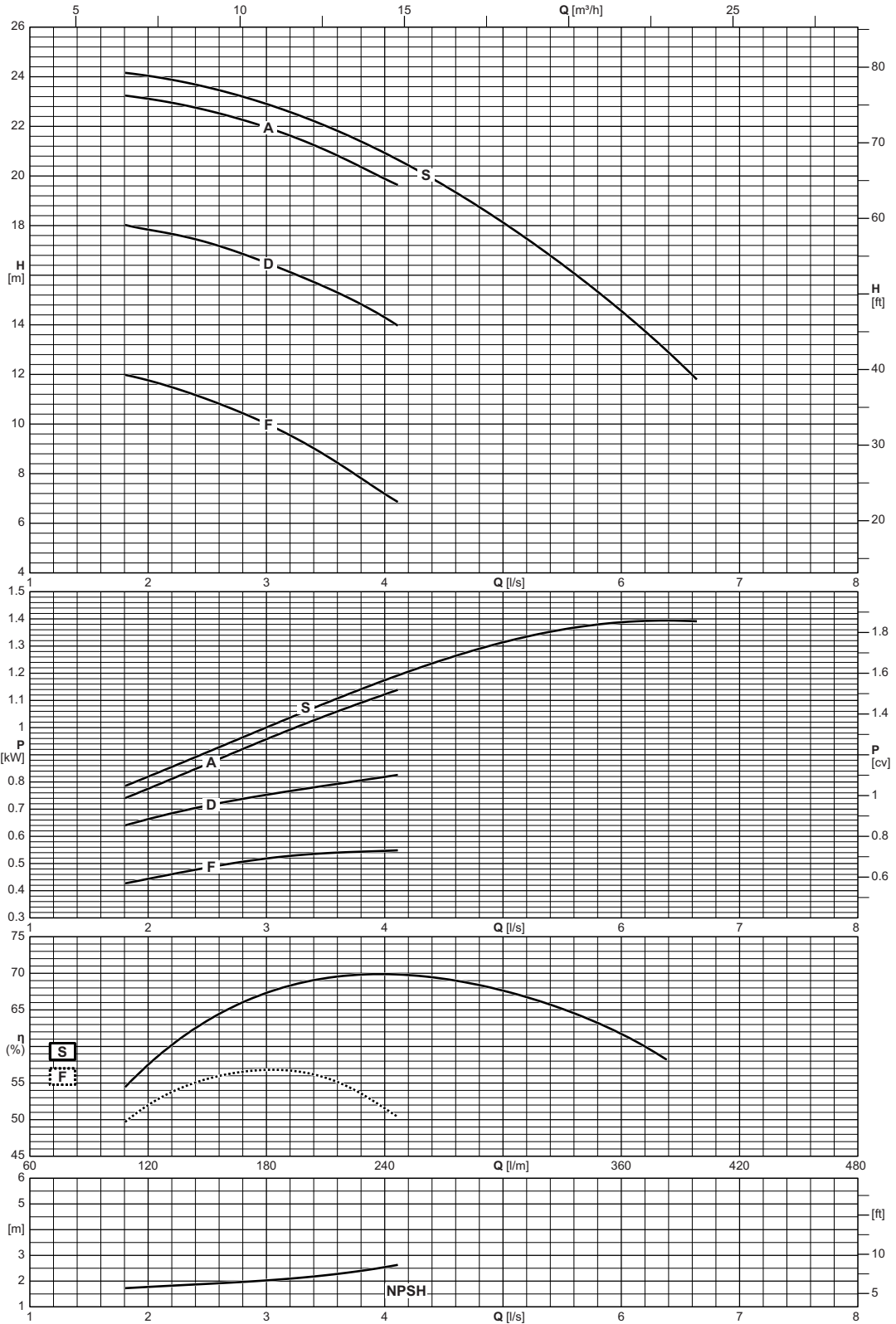

Type Type Tipo	Inlet maximum pressure Pression maximale en aspiration Pressione massima in aspirazione
NCDS2P32-125	[bar] 10

NCDS 2P32-160

3450 n [min⁻¹]



Operating data
 Caracteristiques de fonctionnement
 Caratteristiche di funzionamento

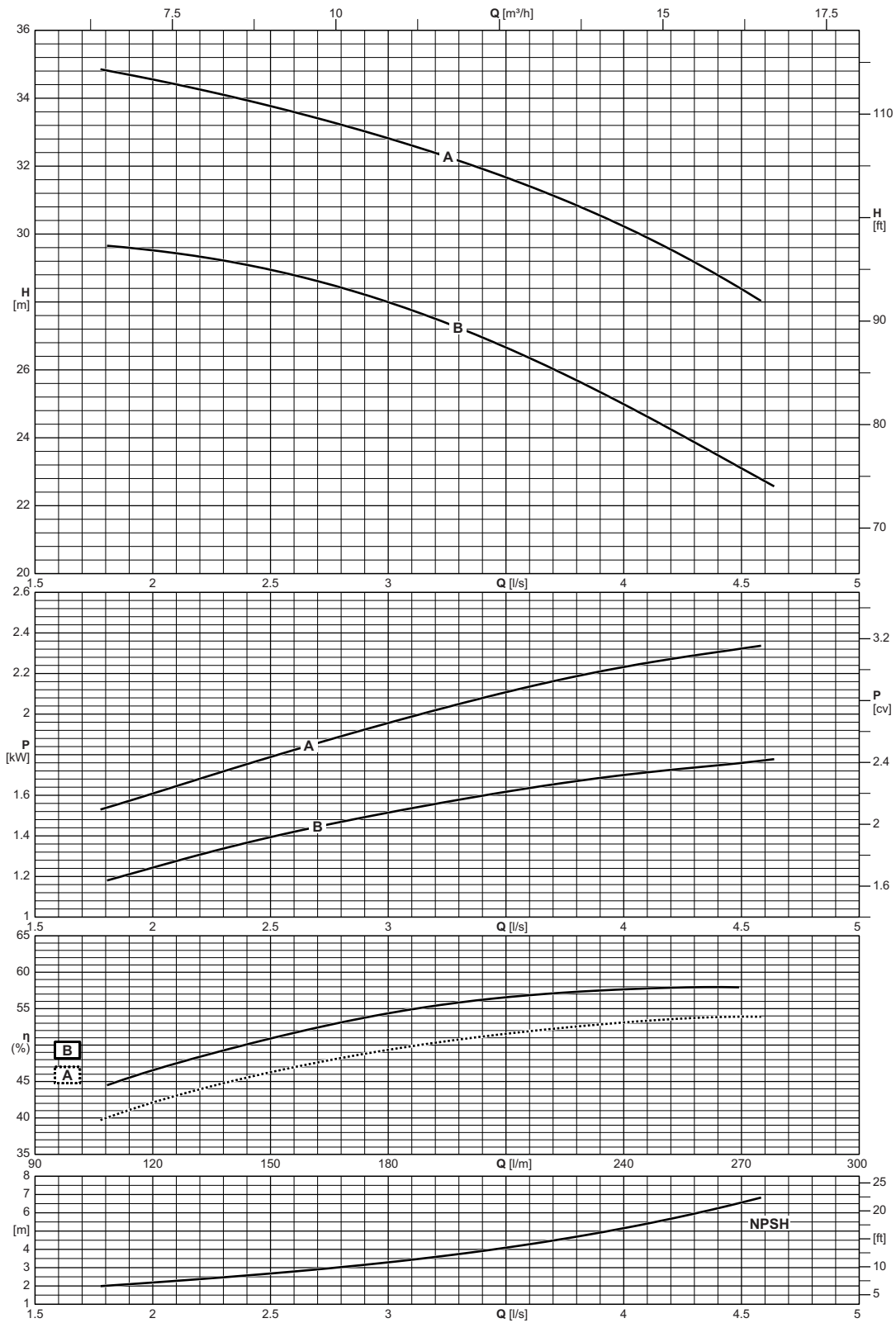

Type Type Tipo	Inlet maximum pressure Pression maximale en aspiration Pressione massima in aspirazione
NCDS2P32-160	[bar] 10

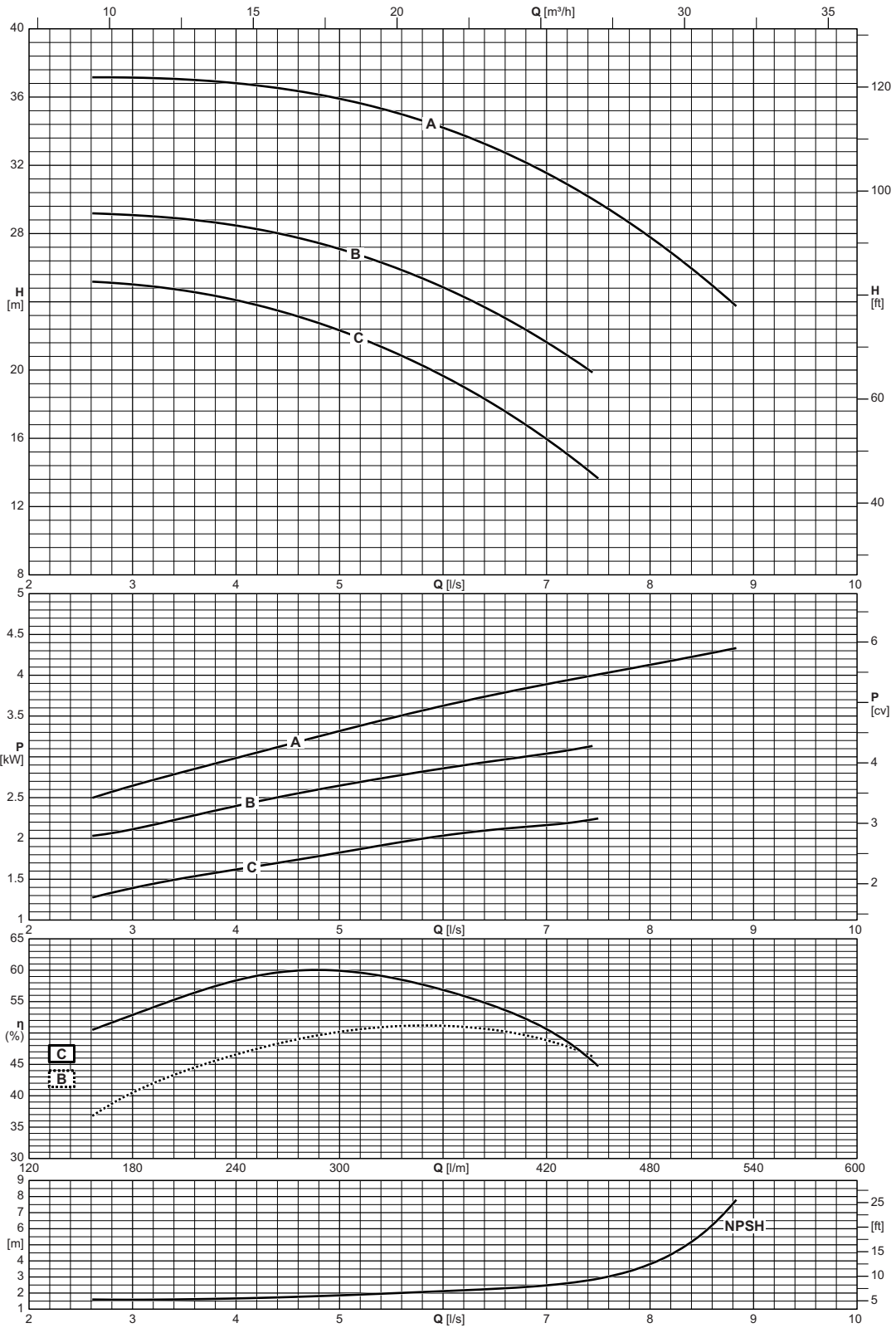

Type Type Tipo	Inlet maximum pressure Pression maximale en aspiration Pressione massima in aspirazione
NCDS2P32L-160	[bar] 10

NCDS 2P32-200

3450 n [min⁻¹]



Operating data
Caracteristiques de fonctionnement
Caratteristiche di funzionamento

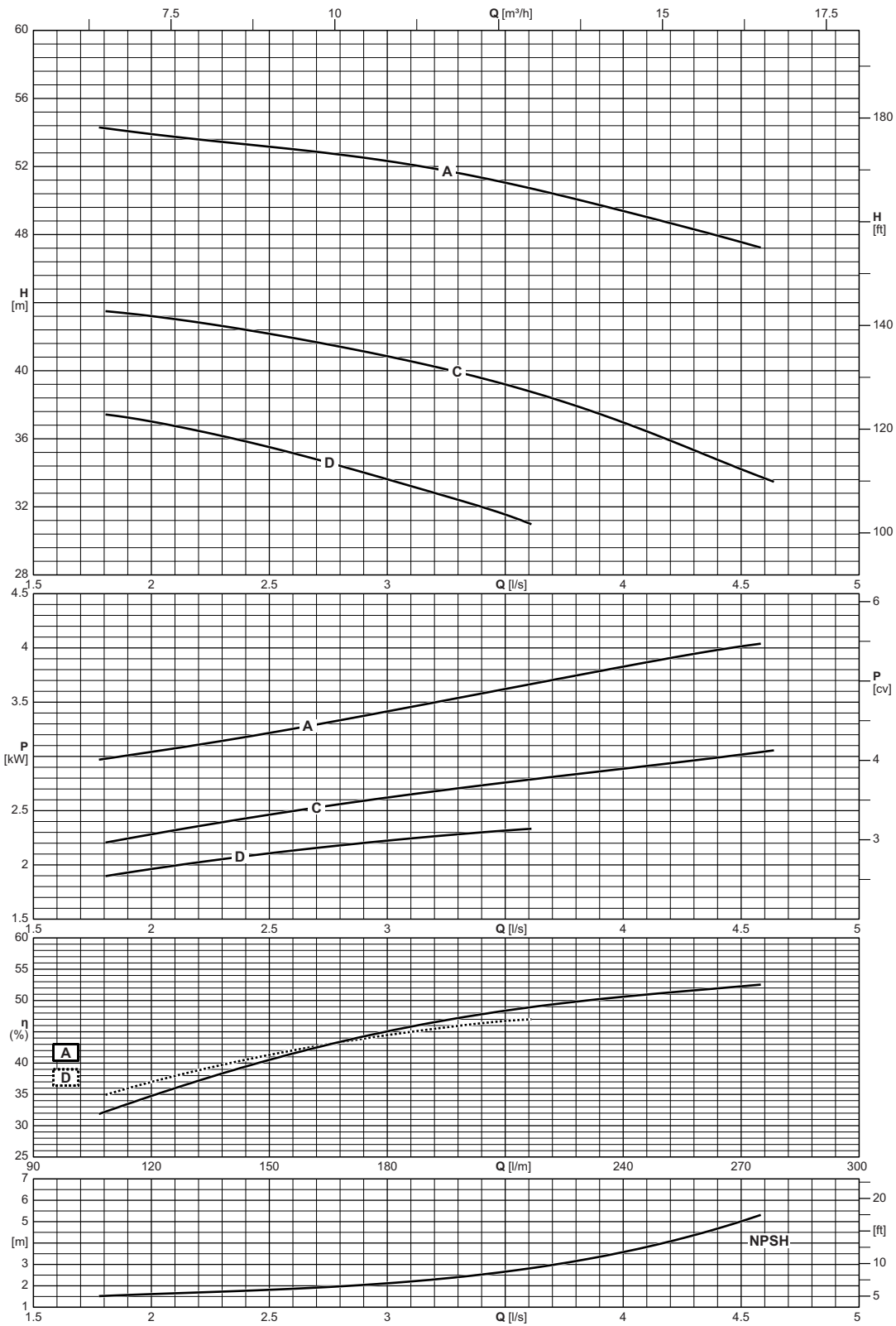

Type Type Tipo	Inlet maximum pressure Pression maximale en aspiration Pressione massima in aspirazione
NCDS2P32-200	[bar] 10

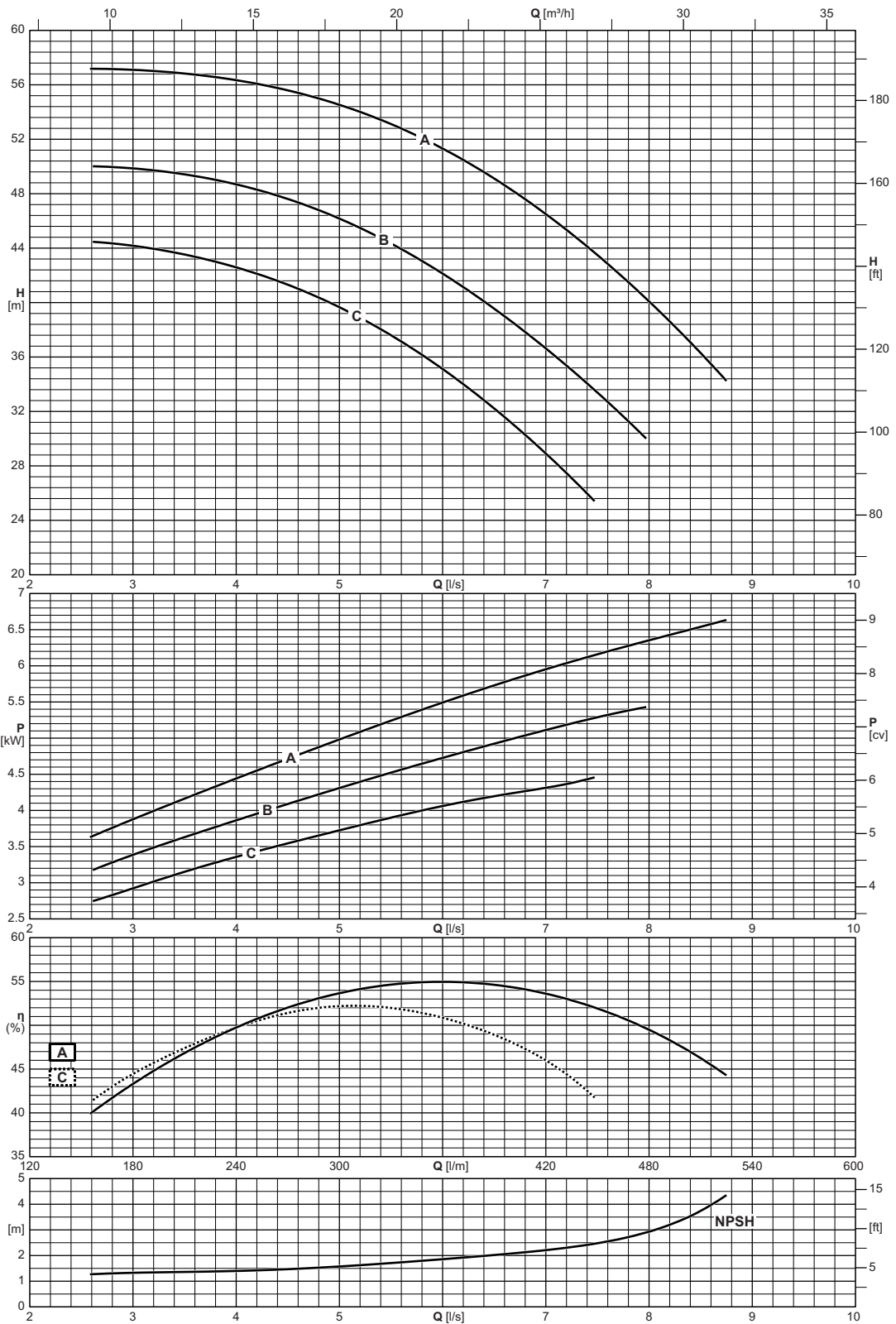

Type Type Tipo	Inlet maximum pressure Pression maximale en aspiration Pressione massima in aspirazione
NCDS2P32L-200	[bar] 10

NCDS 2P40-125

3450 n [min⁻¹]



Operating data
Caracteristiques de fonctionnement
Caratteristiche di funzionamento

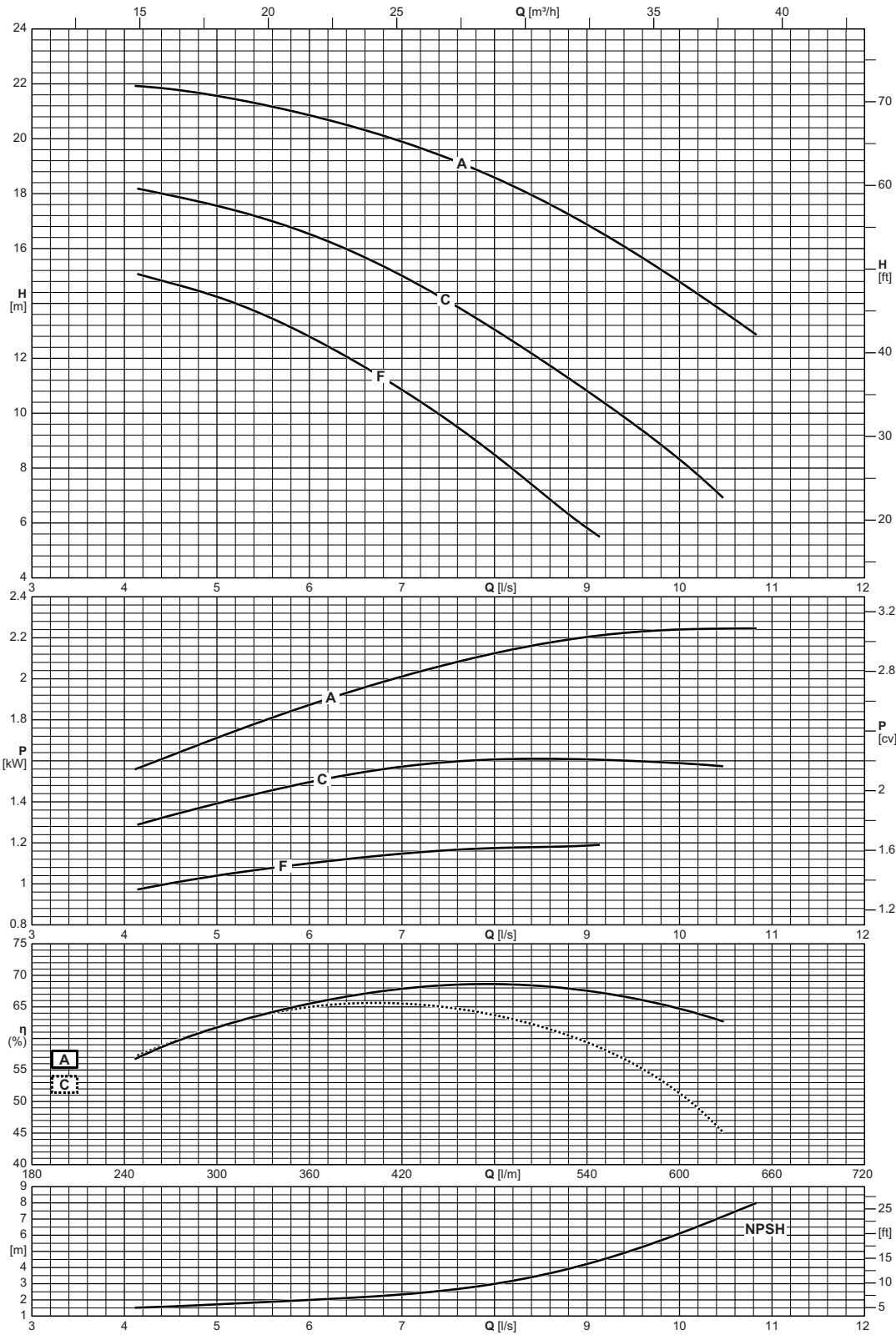

Type Type Tipo	Inlet maximum pressure Pression maximale en aspiration Pressione massima in aspirazione
NCDS2P40-125	[bar] 10

Operating data
 Caracteristiques de fonctionnement
 Caratteristiche di funzionamento

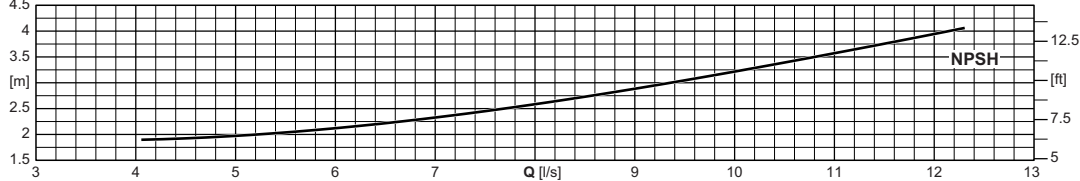
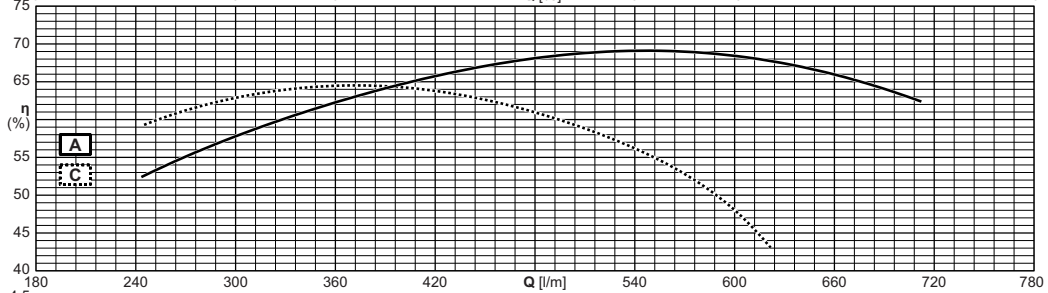
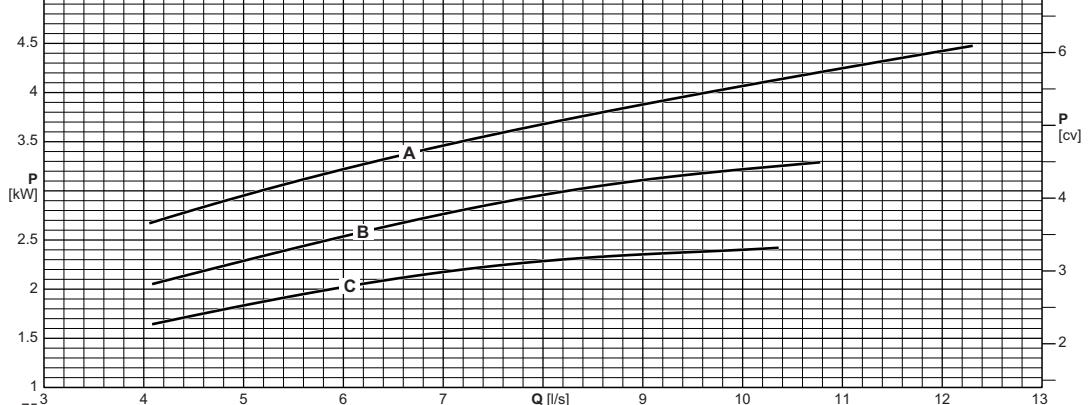
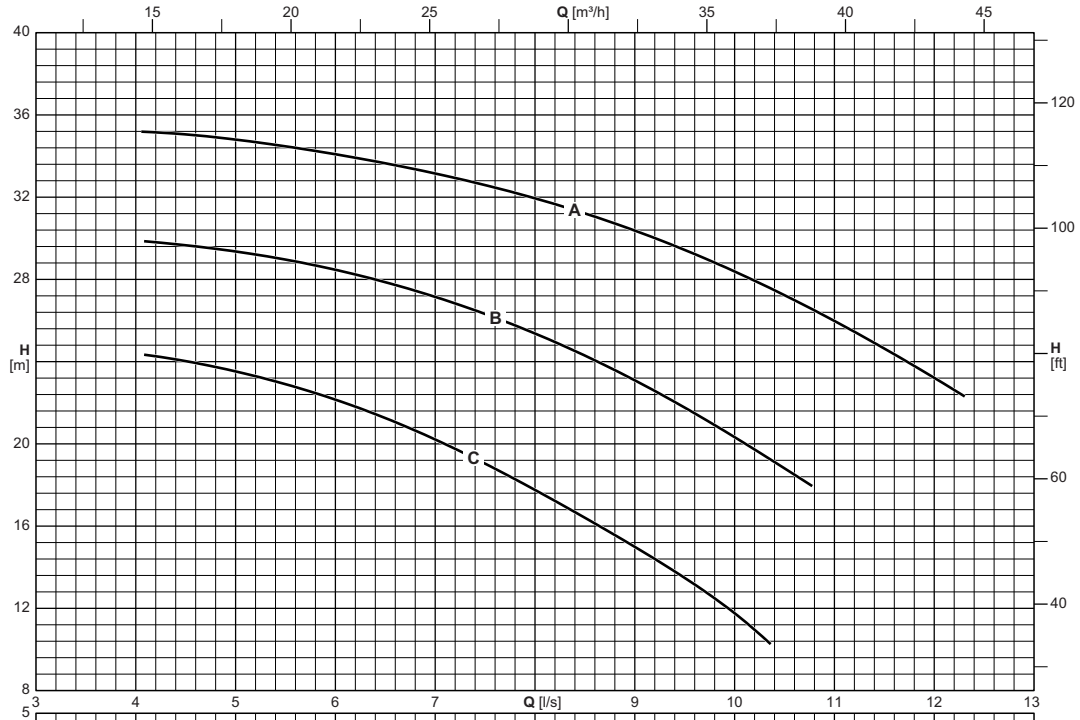

Type Type Tipo	Inlet maximum pressure Pression maximale en aspiration Pressione massima in aspirazione
NCDS2P40-160	[bar] 10

NCDS 2P40-200

3450 n [min⁻¹]



Operating data
 Caracteristiques de fonctionnement
 Caratteristiche di funzionamento

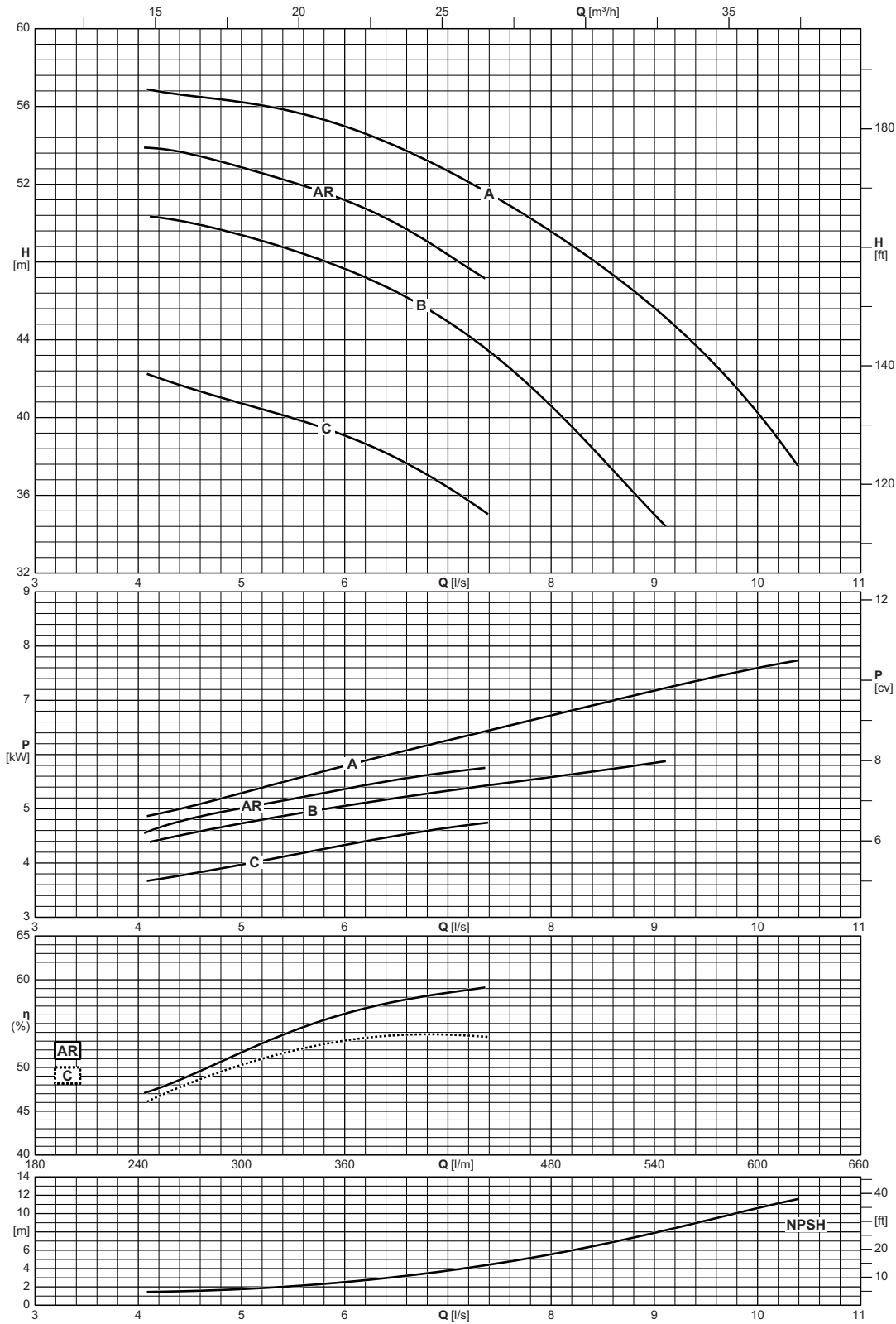

Type Type Tipo	Inlet maximum pressure Pression maximale en aspiration Pressione massima in aspirazione
NCDS2P40-200	[bar]
	10

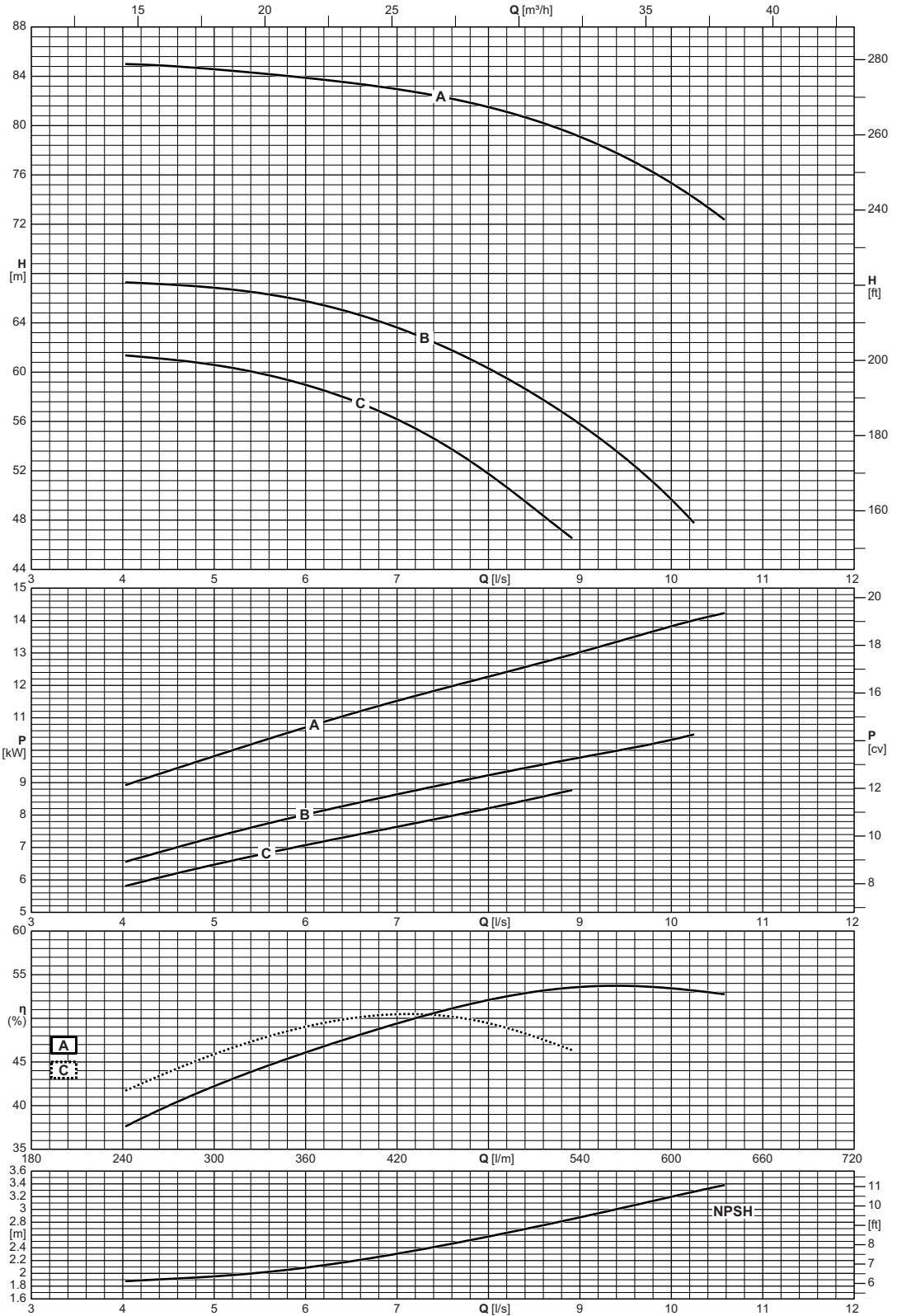

Type Type Tipo	Inlet maximum pressure Pression maximale en aspiration Pressione massima in aspirazione
NCDS2P40-250	[bar] 10

NCDS 2P50-125

3450 n [min⁻¹]



Operating data
 Caracteristiques de fonctionnement
 Caratteristiche di funzionamento

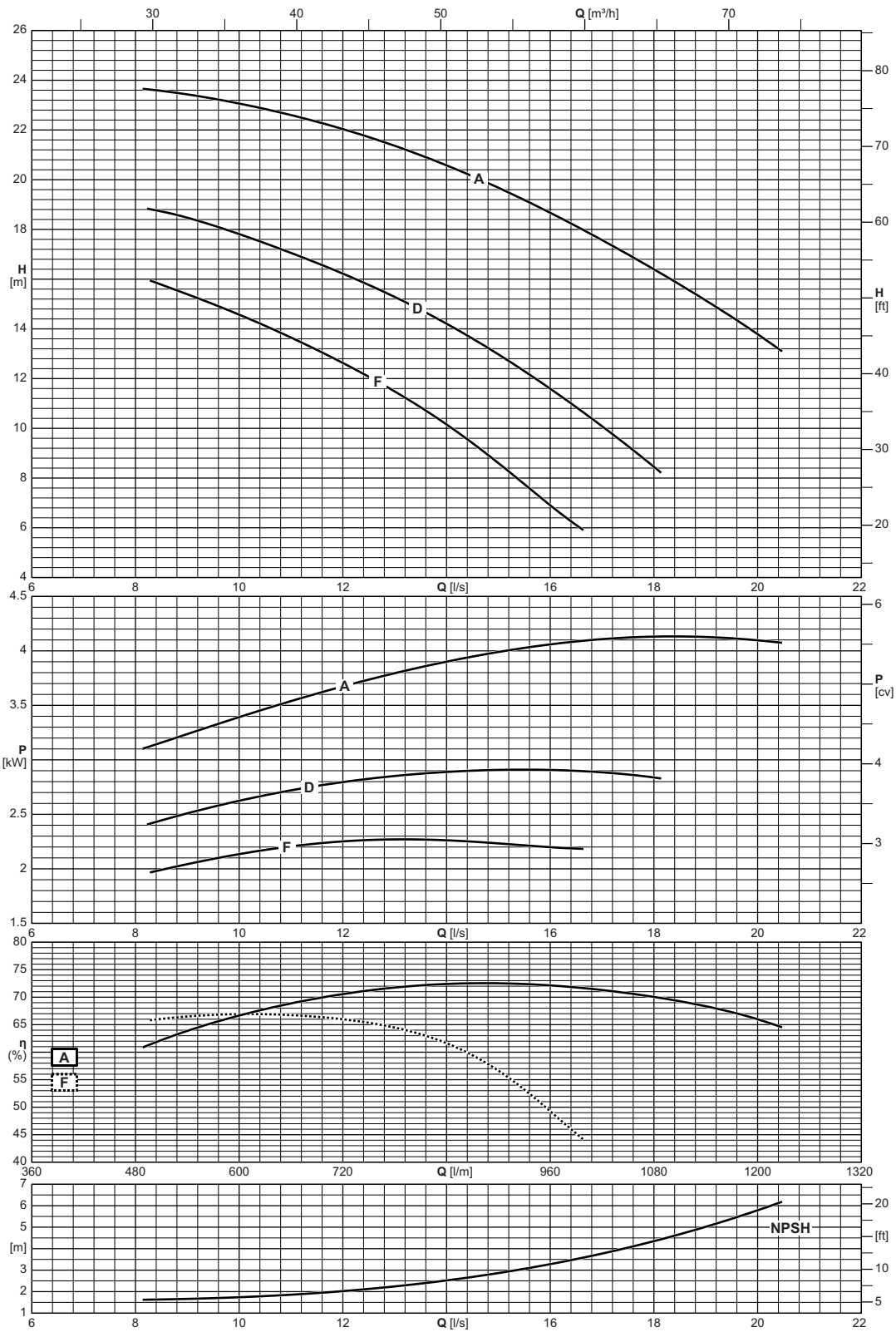

Type Type Tipo	Inlet maximum pressure Pression maximale en aspiration Pressione massima in aspirazione
NCDS2P50-125	[bar]
	10

Operating data
 Caracteristiques de fonctionnement
 Caratteristiche di funzionamento

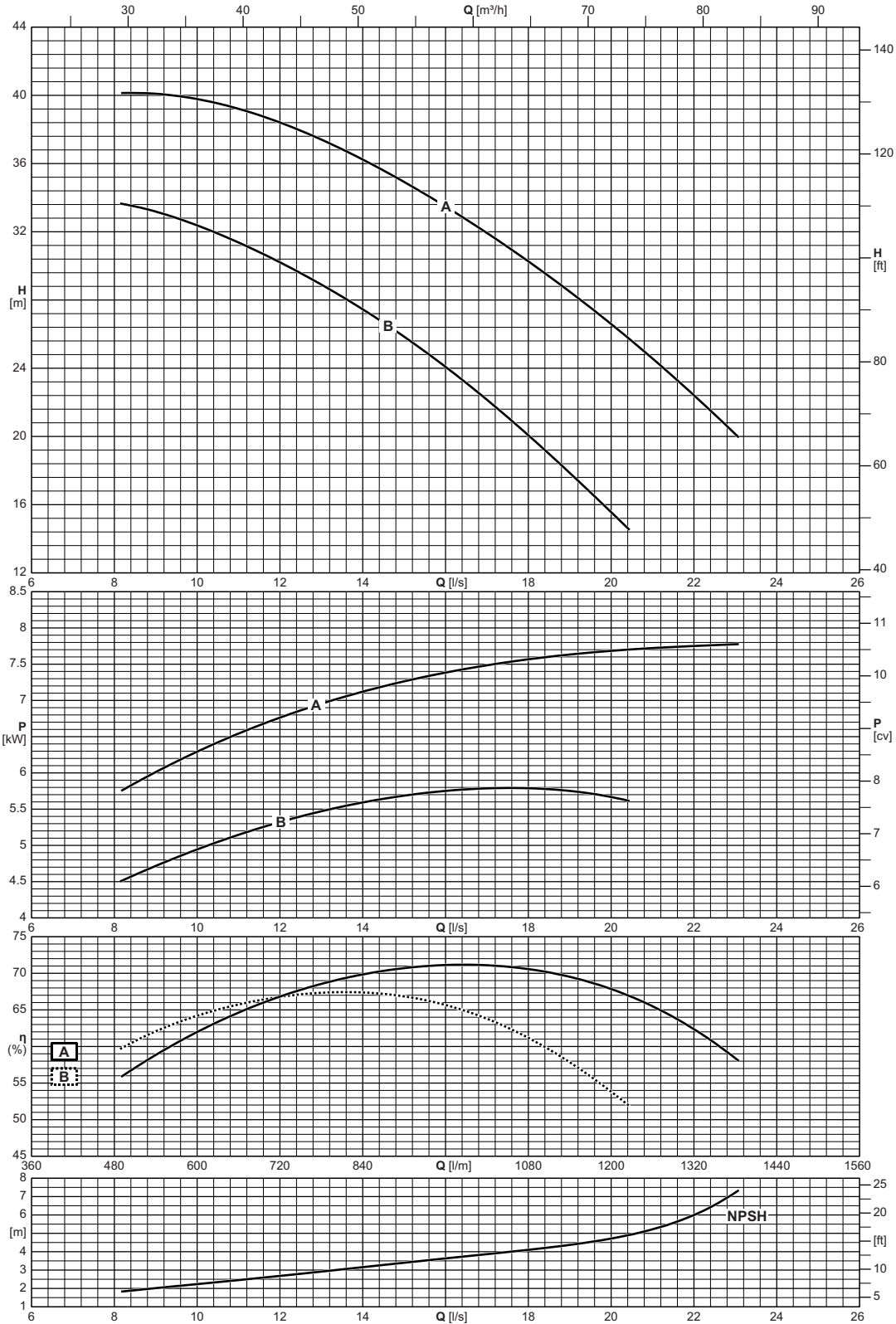

Type Type Tipo	Inlet maximum pressure Pression maximale en aspiration Pressione massima in aspirazione
NCDS2P50-160	[bar] 10

NCDS 2P50-200

3450 n [min⁻¹]



Operating data
 Caracteristiques de fonctionnement
 Caratteristiche di funzionamento

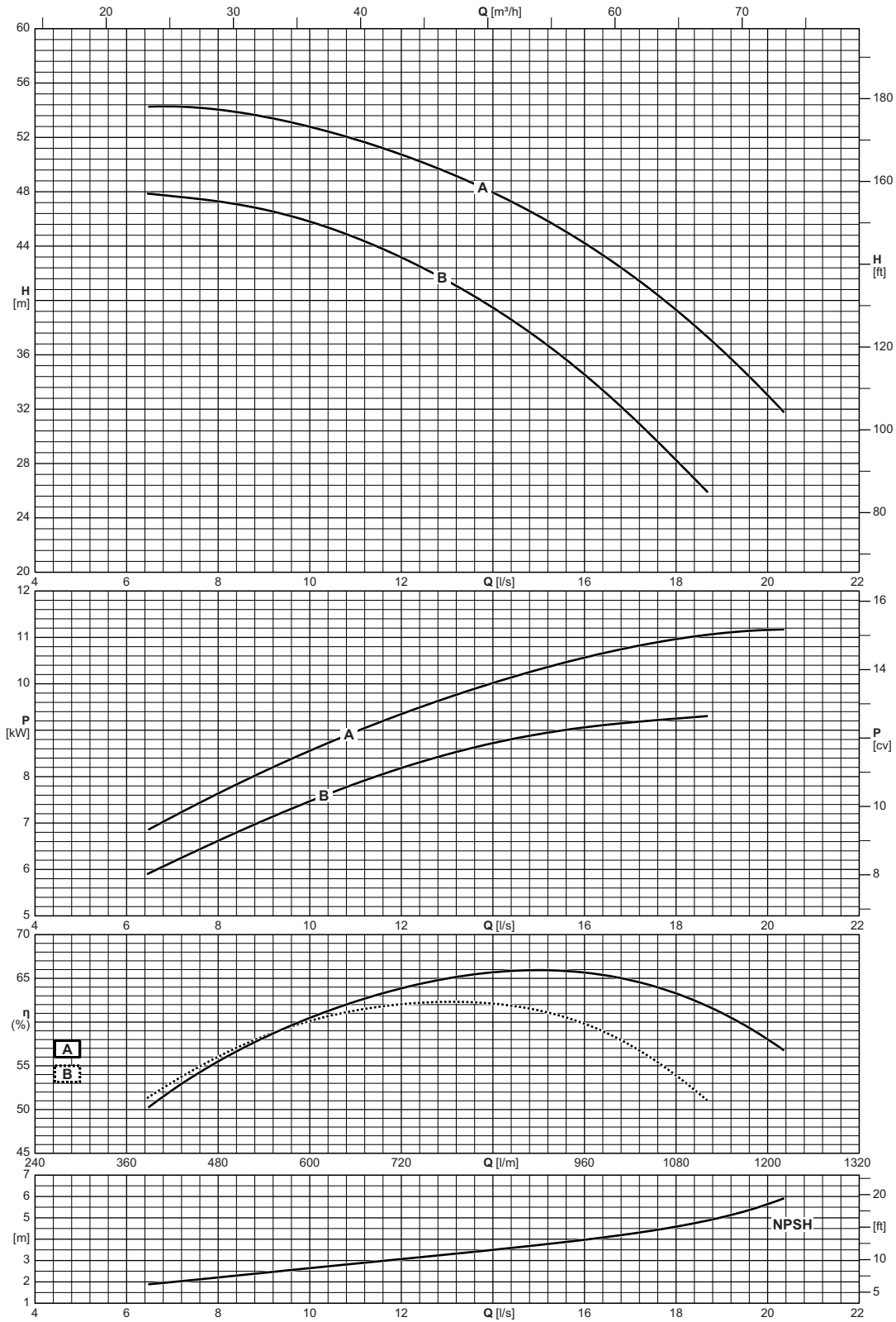

Type Type Tipo	Inlet maximum pressure Pression maximale en aspiration Pressione massima in aspirazione
NCDS2P50-200	[bar]
	10

Operating data
 Caracteristiques de fonctionnement
 Caratteristiche di funzionamento

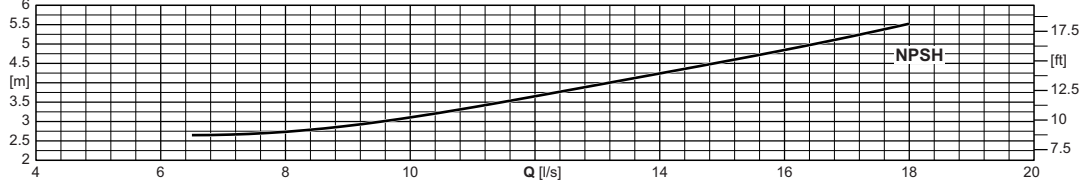
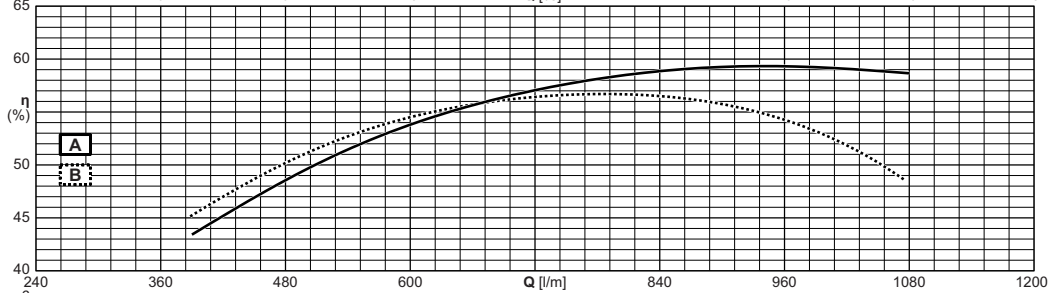
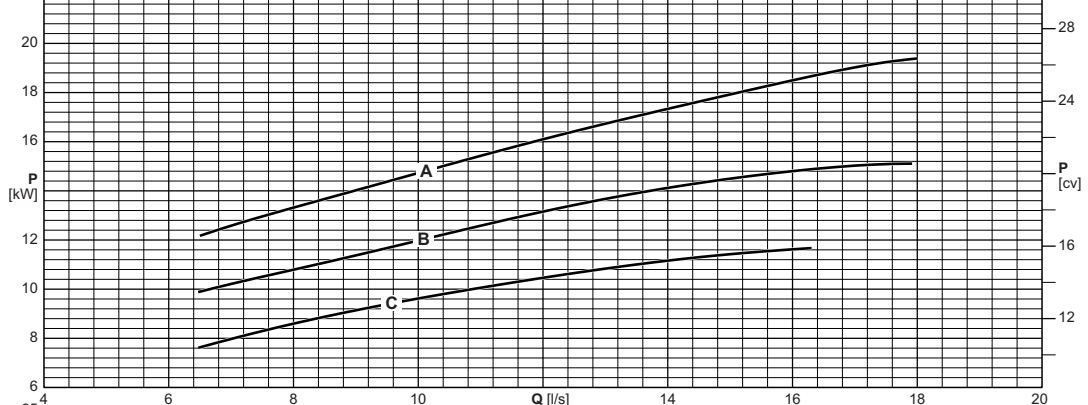
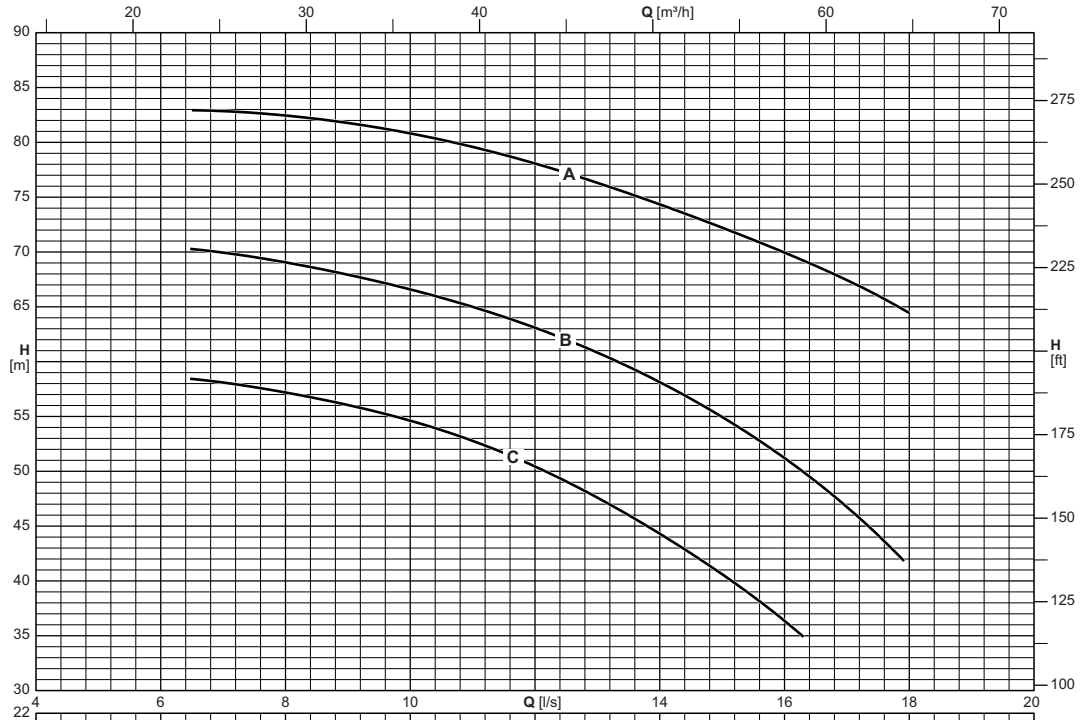

Type Type Tipo	Inlet maximum pressure Pression maximale en aspiration Pressione massima in aspirazione
NCDS2P50-250	[bar] 10

NCDS 2P65-125

3450 n [min⁻¹]



Operating data
Caracteristiques de fonctionnement
 Caratteristiche di funzionamento

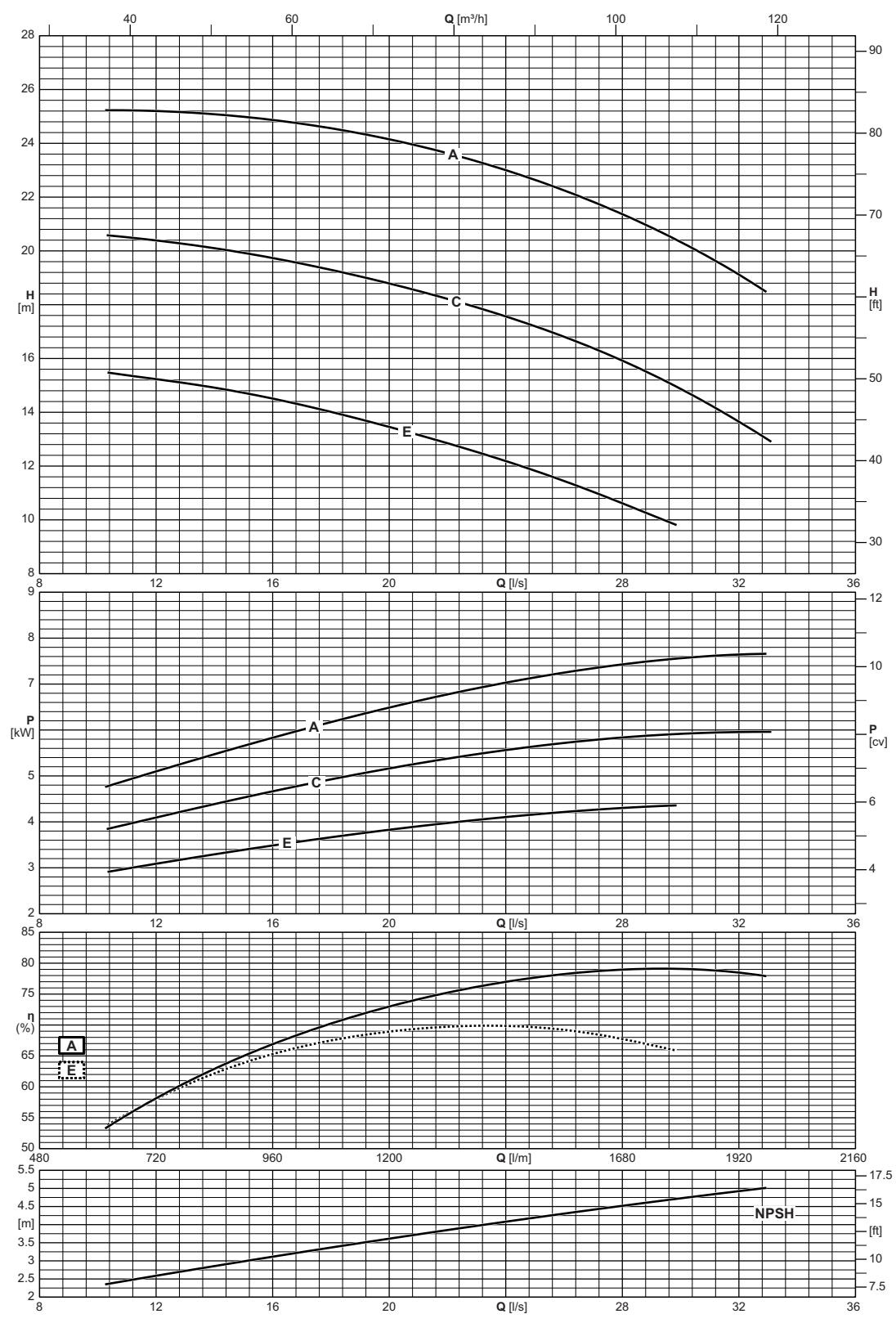

Type Type Tipo	Inlet maximum pressure <i>Pression maximale en aspiration</i> Pressione massima in aspirazione
NCDS2P65-125	[bar] 10

Cod. 998911/10-23 - Copyright © 2006 Caprari S.p.A. - All Rights Reserved

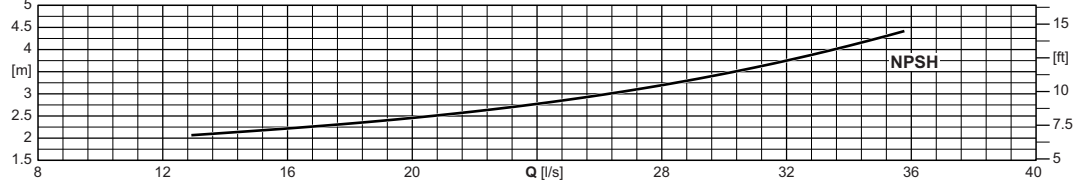
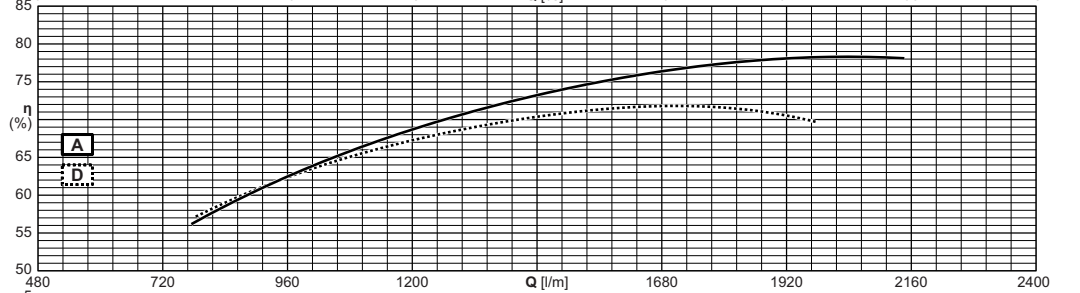
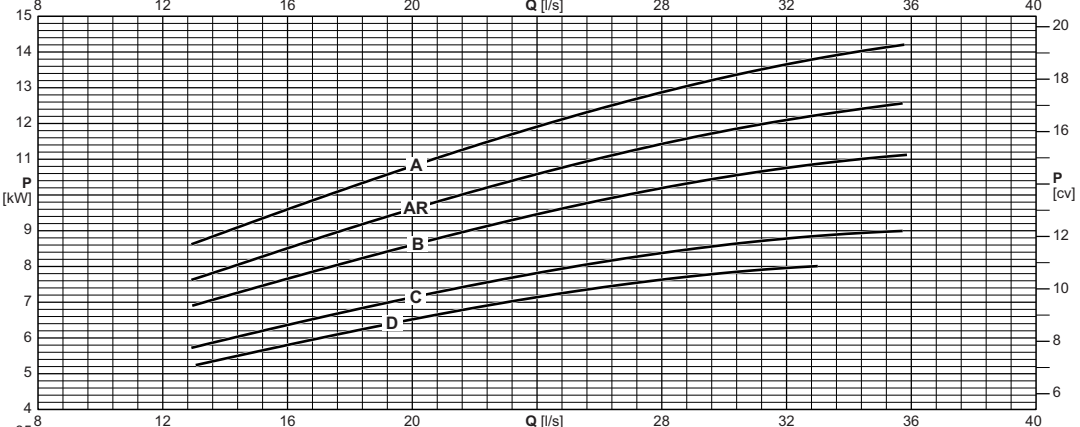
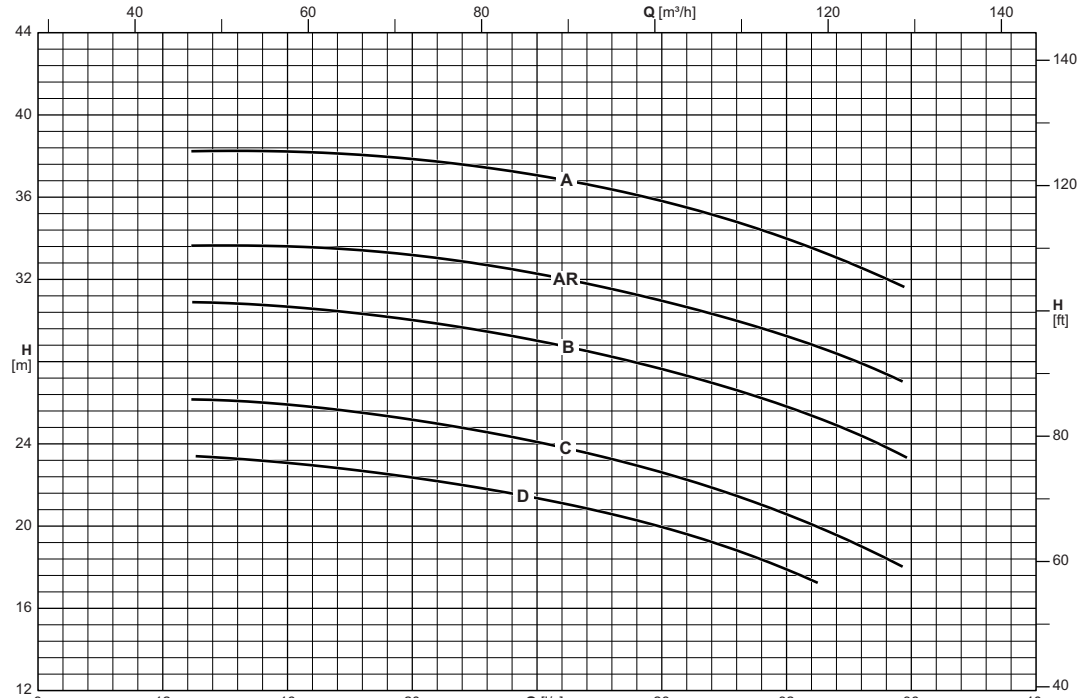

Type Type Tipo	Inlet maximum pressure Pression maximale en aspiration Pressione massima in aspirazione
NCDS2P65-160	[bar] 10

NCDS 2P65-200

3450 n [min⁻¹]



Operating data
Caracteristiques de fonctionnement
Caratteristiche di funzionamento

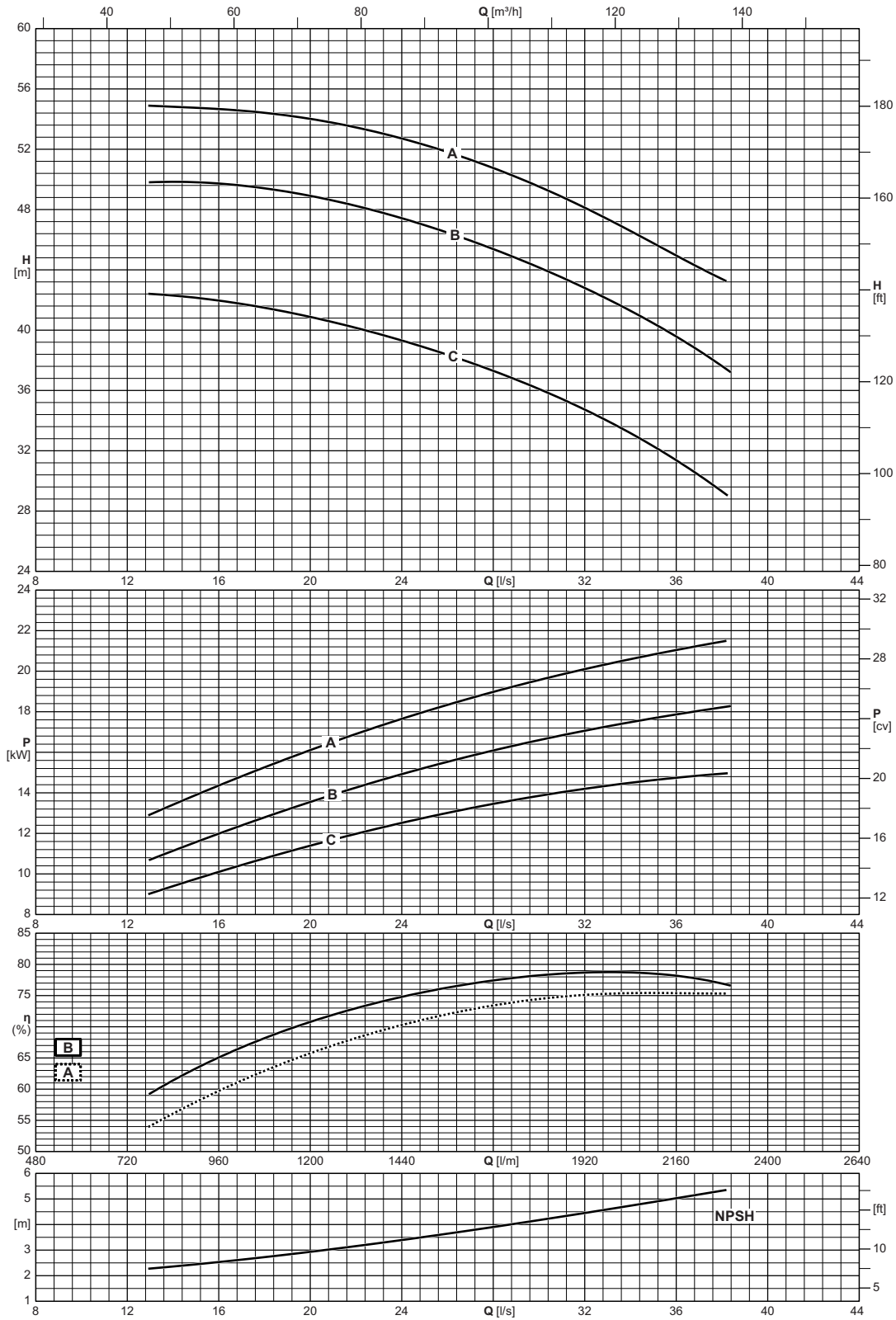

Type Type Tipo	Inlet maximum pressure Pression maximale en aspiration Pressione massima in aspirazione
NCDS2P65-200	[bar] 10

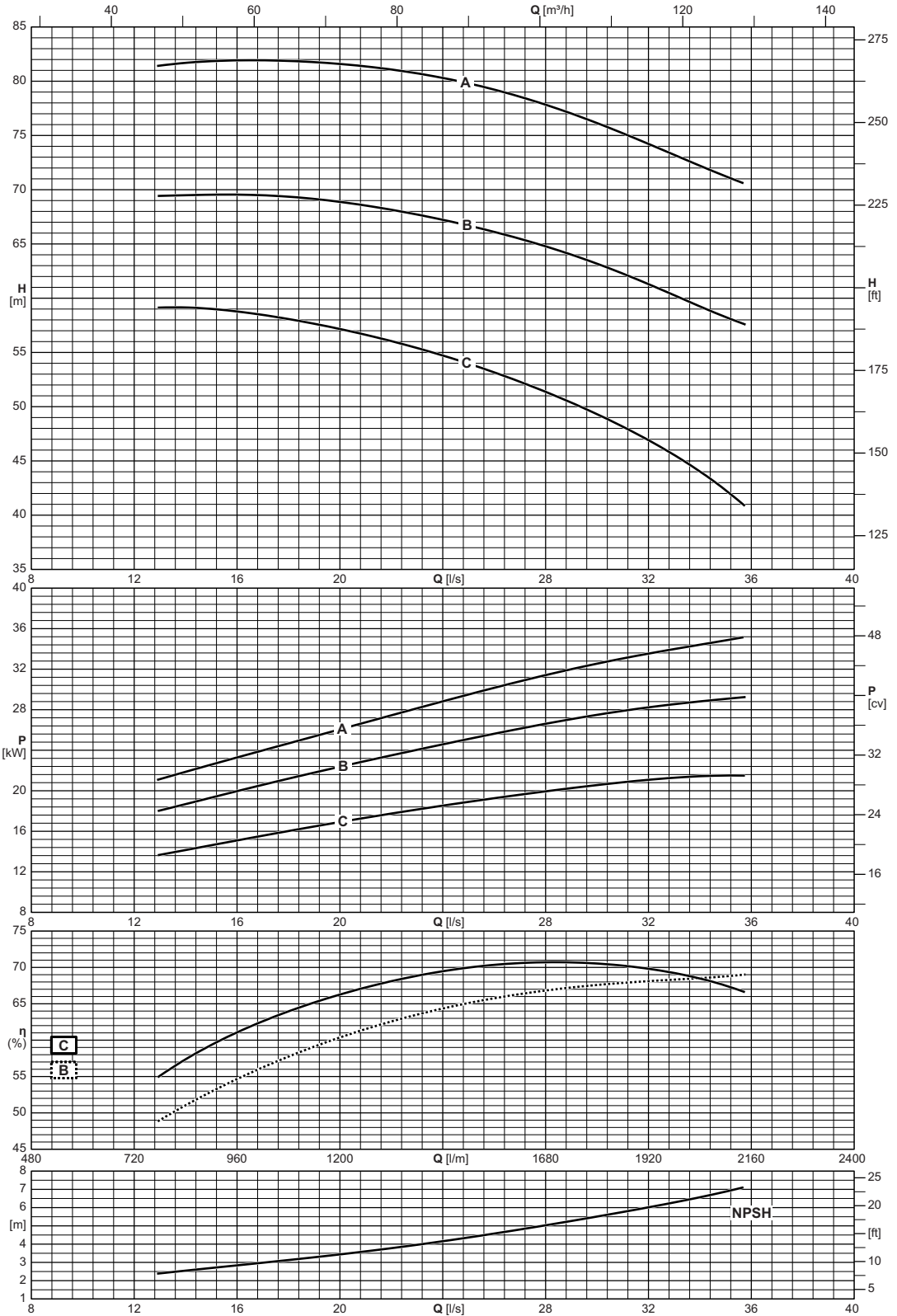

Type Type Tipo	Inlet maximum pressure Pression maximale en aspiration Pressione massima in aspirazione
NCDS2P65-250	[bar] 10

NCDS 2P80-160

3450 n [min⁻¹]



Operating data
Caracteristiques de fonctionnement
Caratteristiche di funzionamento

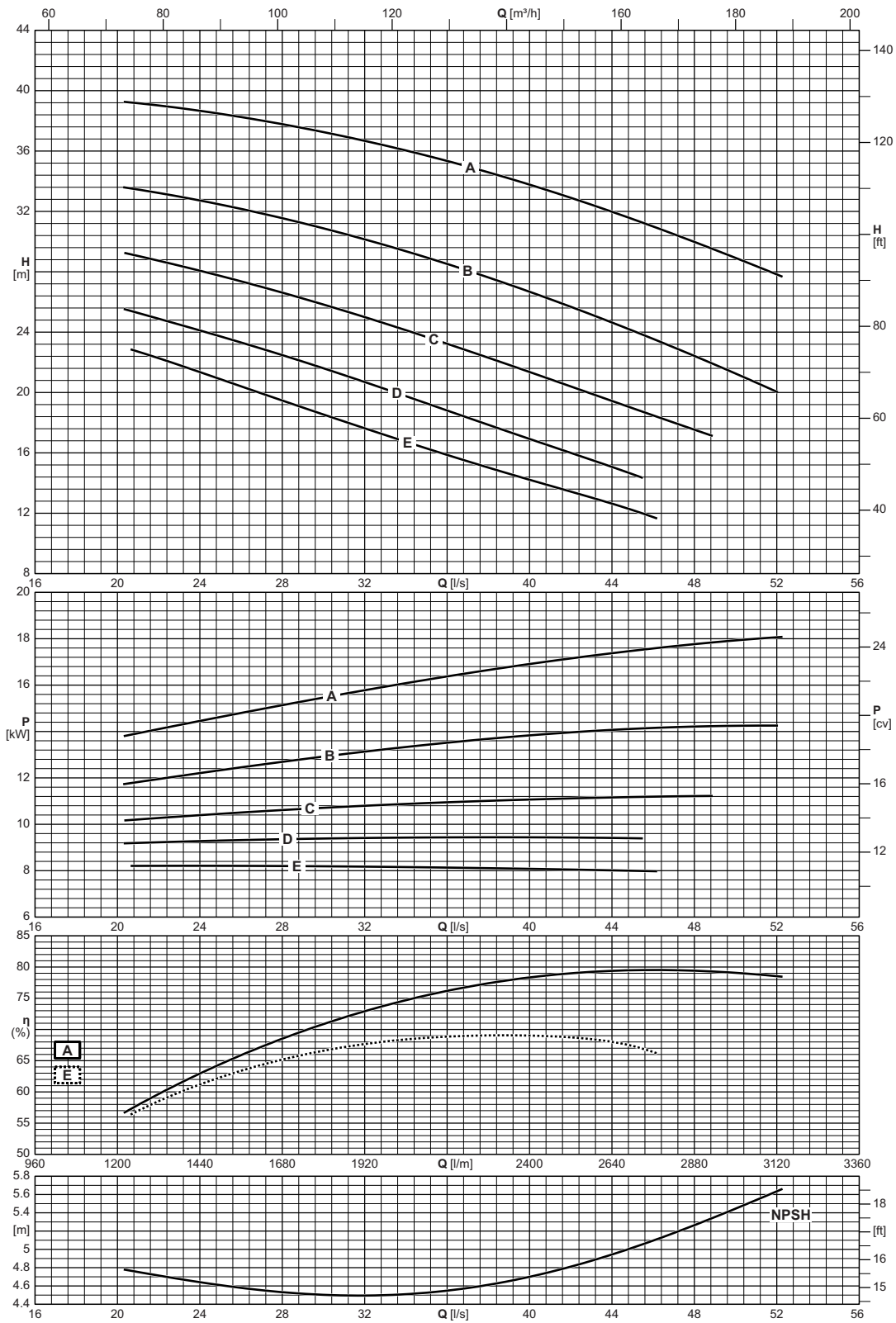

Type Type Tipo	Inlet maximum pressure Pression maximale en aspiration Pressione massima in aspirazione
NCDS2P80-160	[bar] 10

Operating data
 Caracteristiques de fonctionnement
 Caratteristiche di funzionamento

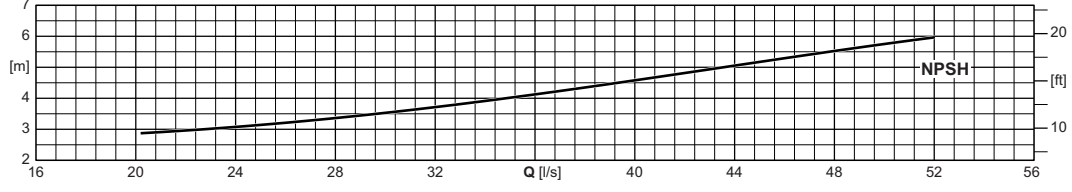
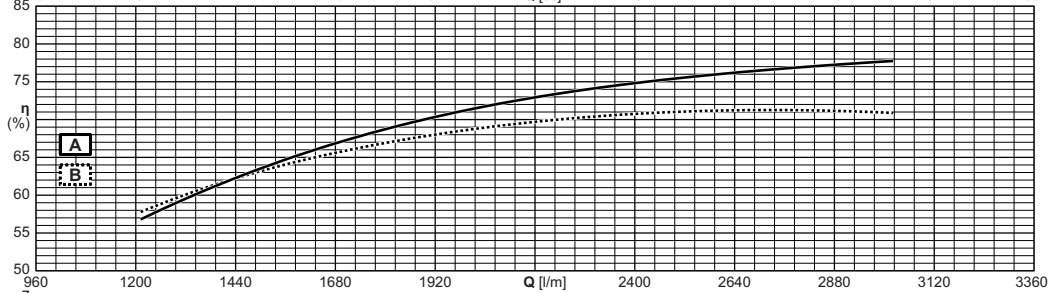
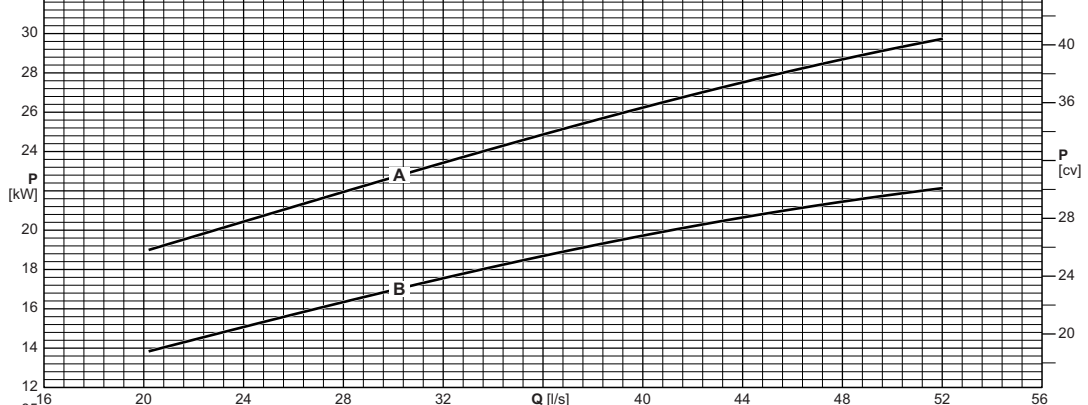
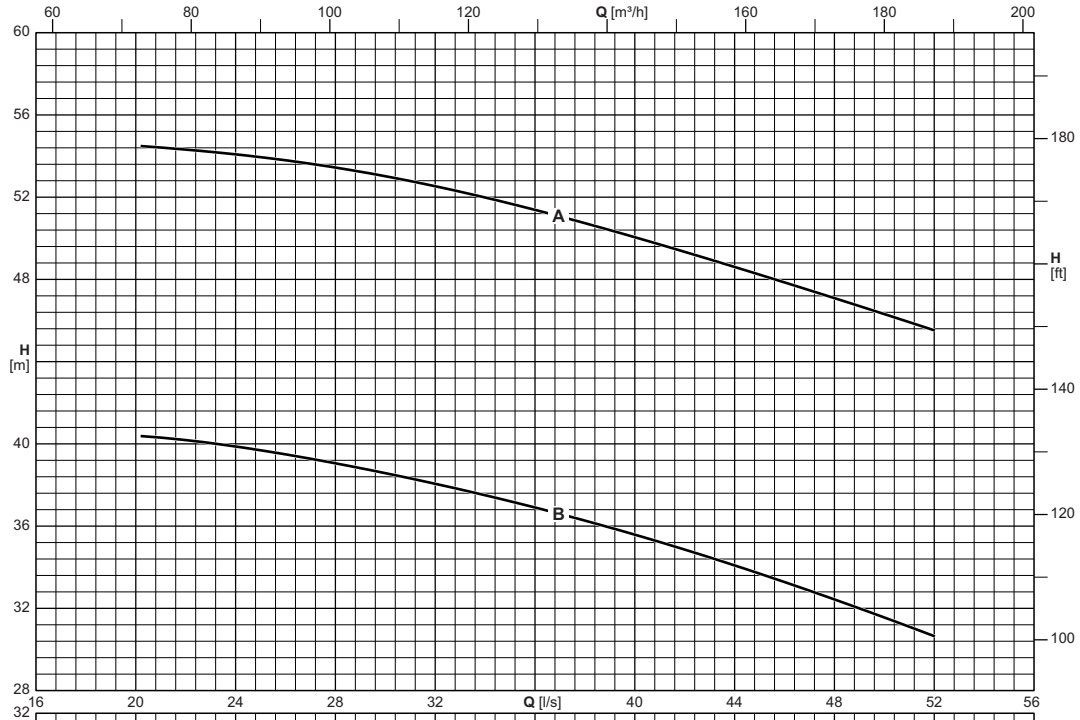

Type Type Tipo	Inlet maximum pressure Pression maximale en aspiration Pressione massima in aspirazione
NCDS2P80-200	[bar] 10

NCDS 2P80-250

3450 n [min⁻¹]



Operating data
 Caracteristiques de fonctionnement
 Caratteristiche di funzionamento

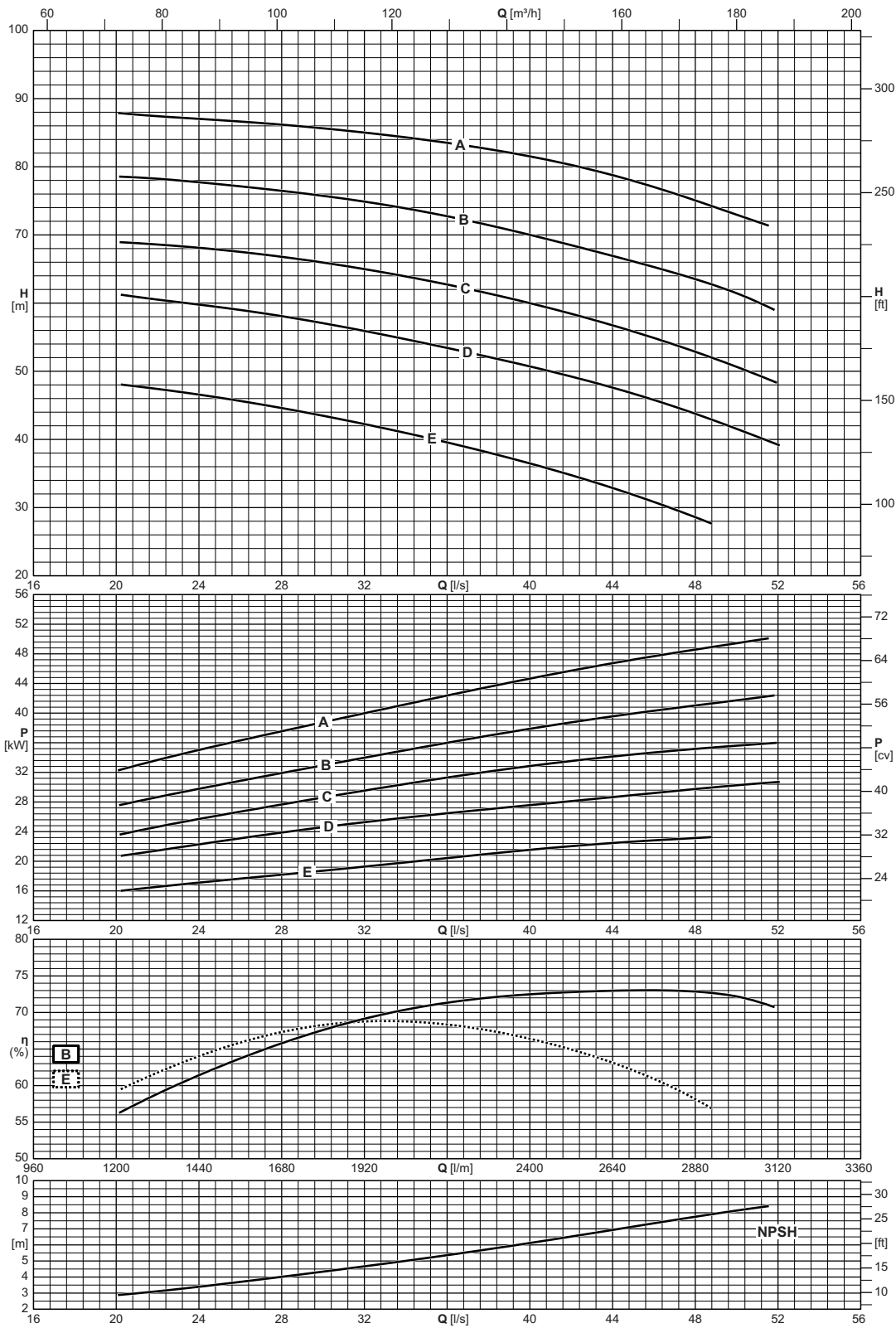

Type Type Tipo	Inlet maximum pressure Pression maximale en aspiration Pressione massima in aspirazione
NCDS2P80-250	[bar]
	10

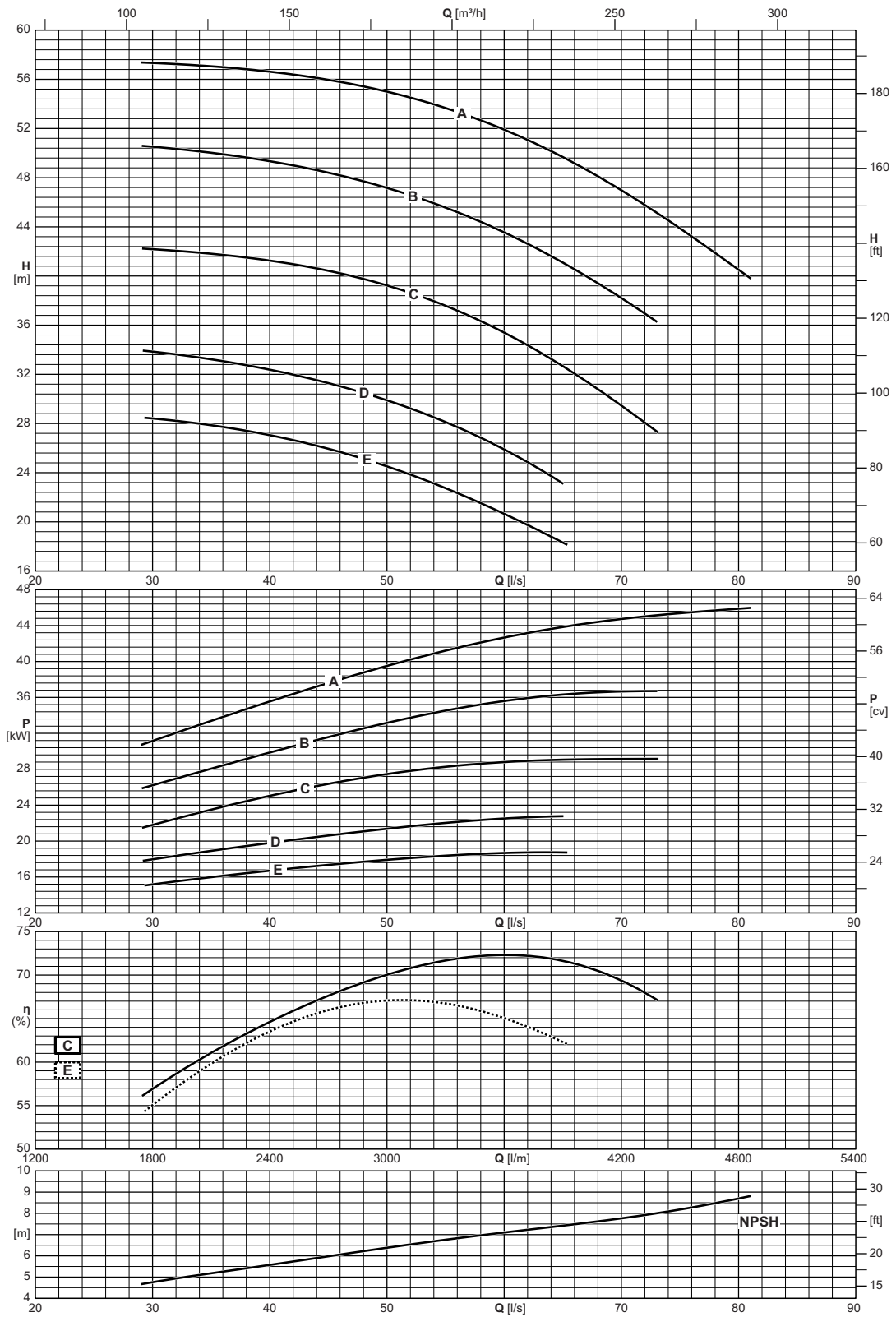

Type Type Tipo	Inlet maximum pressure Pression maximale en aspiration Pressione massima in aspirazione
NCDS2P100-200	[bar] 10

NCDS 2P100-250

3450 n [min⁻¹]



Operating data
Caracteristiques de fonctionnement
Caratteristiche di funzionamento

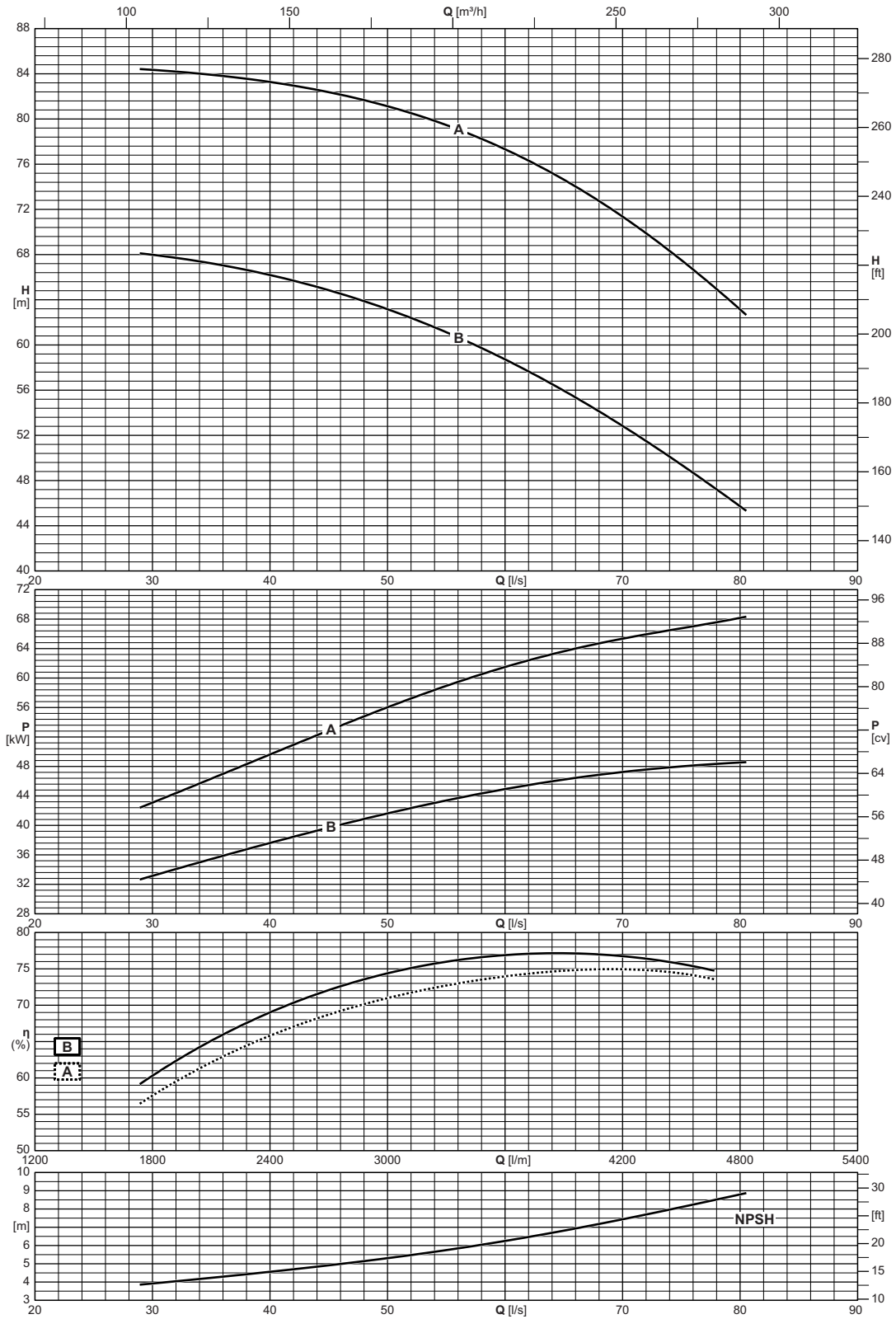

Type Type Tipo	Inlet maximum pressure Pression maximale en aspiration Pressione massima in aspirazione
NCDS2P100-250	[bar] 10

Overall dimensions and weights
 Dimensions d'encombrement et poids
 Dimensioni di ingombro e pesi

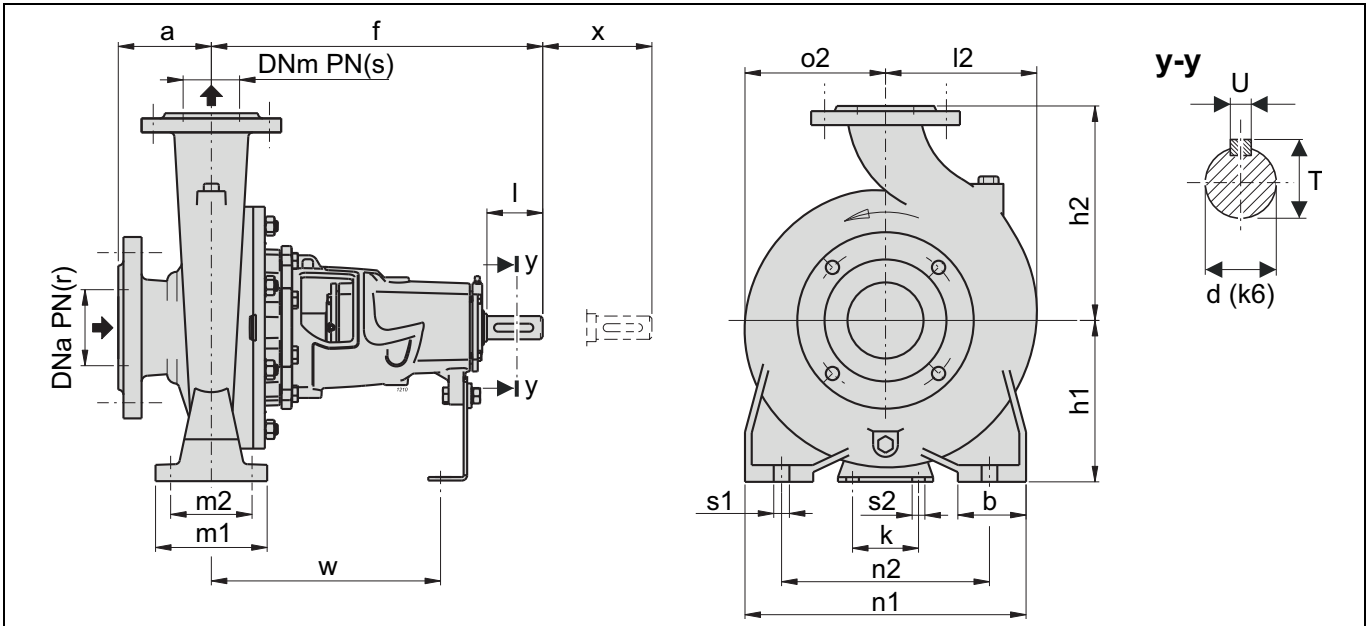

Type Type Tipo	Weight Poids Peso [kg]	Dimensions pump Dimensions pompe Dimensioni pompa										Duck foot pedestal dimensions Dimensiones pieds de soutien Dimensioni piedi di appoggio							Shaft projection Saillie d'arbre Sporgenza d'albero				
		DNa	DNm	r	s	a	f	h1	h2	l2	o2	b	m1	m2	n1	n2	k	w	s1	s2	d	l	T
		[mm]																					
NCD(S)2P32-125	26	50	32	10	10	80	360	112	140	97	93	50	100	70	190	140	110	260	ø 14	ø 14	24	50	50
NCD(S)2P32-160	33	50	32	10	10	80	360	132	160	120	120	50	100	70	240	190	110	260	ø 14	ø 14	24	50	50
NCD(S)2P32L-160	31	50	32	10	10	80	360	132	160	120	120	50	100	70	240	190	110	260	ø 14	ø 14	24	50	50
NCD(S)2P32L-200	40	50	32	10	10	80	360	160	180	140	140	50	100	70	265	212	110	260	ø 14	ø 14	24	50	50
NCD(S)2P32-200	38	50	32	10	10	80	360	160	180	140	140	50	100	70	240	190	110	260	ø 14	ø 14	24	50	50
NCD(S)2P40-125	28	65	40	10	10	80	360	112	140	113	100	50	100	70	210	160	110	260	ø 14	ø 14	24	50	65
NCD(S)2P40-160	33	65	40	10	10	80	360	132	160	119	119	50	100	70	240	190	110	260	ø 14	ø 14	24	50	65
NCD(S)2P40-200	40	65	40	10	10	100	360	160	180	140	140	50	100	70	265	212	110	260	ø 14	ø 14	24	50	65
NCD(S)2P40-250	55	65	40	10	10	100	360	180	225	175	175	65	125	95	320	250	110	260	ø 14	ø 14	24	50	65
NCD(S)2P50-125	34	65	50	10	10	100	360	132	160	137	121	50	100	70	240	190	110	260	ø 14	ø 14	24	50	65
NCD(S)2P50-160	33	65	50	10	10	100	360	160	180	141	127	50	100	70	265	212	110	260	ø 14	ø 14	24	50	65
NCD(S)2P50-200	44	65	50	10	10	100	360	160	200	153	140	50	100	70	265	212	110	260	ø 14	ø 14	24	50	65
NCD(S)2P50-250	57	65	50	10	10	100	360	180	225	175	175	65	125	95	320	250	110	260	ø 14	ø 14	24	50	65
NCD(S)2P65-125	38	80	65	10	10	100	360	160	180	155	134	65	125	95	280	212	110	260	ø 14	ø 14	24	50	80
NCD(S)2P65-160	40	80	65	10	10	100	360	160	200	172	150	65	125	95	280	212	110	260	ø 14	ø 14	24	50	80
NCD(S)2P65-200	48	80	65	10	10	100	360	180	225	175	155	65	125	95	320	250	110	260	ø 14	ø 14	24	50	80
NCD(S)2P65-250	88	80	65	10	10	100	470	200	250	190	175	80	160	120	360	280	110	340	ø 18	ø 14	24	50	80
NCD(S)2P80-160	48	100	80	10	10	125	360	180	225	193	165	65	125	95	320	250	110	260	ø 14	ø 14	24	50	100
NCD(S)2P80-200	80	100	80	10	10	125	470	180	250	194	170	65	125	95	345	280	110	340	ø 14	ø 14	32	80	100
NCD(S)2P80-250	92	100	80	10	10	125	470	200	280	210	191	80	160	120	400	315	110	340	ø 18	ø 14	32	80	100
NCD(S)2P100-200	83	125	100	10	10	125	470	200	280	212	180	80	160	120	360	280	110	340	ø 18	ø 14	32	80	125
NCD(S)2P100-250	103	125	100	10	10	140	470	225	280	233	205	80	160	120	400	315	110	340	ø 18	ø 14	32	80	125
NCD(S)4P32-125	25	50	32	10	10	80	360	112	140	97	93	50	100	70	190	140	110	260	ø 14	ø 14	24	50	50
NCD(S)4P32-160	33	50	32	10	10	80	360	132	160	120	120	50	100	70	240	190	110	260	ø 14	ø 14	24	50	50
NCD(S)4P32-200	37	50	32	10	10	80	360	160	180	140	140	50	100	70	240	190	110	260	ø 14	ø 14	24	50	50
NCD(S)4P40-160	33	65	40	10	10	80	360	132	160	119	119	50	100	70	240	190	110	260	ø 14	ø 14	24	50	65
NCD(S)4P40-200	40	65	40	10	10	100	360	160	180	140	140	50	100	70	265	212	110	260	ø 14	ø 14	24	50	65
NCD(S)4P40-250	55	65	40	10	10	100	360	180	225	175	175	65	125	95	320	250	110	260	ø 14	ø 14	24	50	65
NCD(S)4P50-125	34	65	50	10	10	100	360	132	160	137	121	50	100	70	240	190	110	260	ø 14	ø 14	24	50	65
NCD(S)4P50-160	33	65	50	10	10	100	360	160	180	141	127	50	100	70	265	212	110	260	ø 14	ø 14	24	50	65
NCD(S)4P50-200	44	65	50	10	10	100	360	160	200	153	140	50	100	70	265	212	110	260	ø 14	ø 14	24	50	65
NCD(S)4P50-250	57	65	50	10	10	100	360	180	225	175	175	65	125	95	320	250	110	260	ø 14	ø 14	24	50	65
NCD(S)4P65-125	38	80	65	10	10	100	360	160	180	155	134	65	125	95	280	212	110	260	ø 14	ø 14	24	50	80
NCD(S)4P65-160	40	80	65	10	10	100	360	160	200	172	150	65	125	95	280	212	110	260	ø 14	ø 14	24	50	80
NCD(S)4P65-200	48	80	65	10	10	100	360	180	225	175	155	65	125	95	320	250	110	260	ø 14	ø 14	24	50	80
NCD(S)4P65-250	89	80	65	10	10	100	470	200	250	190	175	80	160	120	360	280	110	340	ø 18	ø 14	24	50	80
NCD(S)4P65-315	131	80	65	10	10	125	470	225	280	220	220	80	160	120	400	315	110	340	ø 18	ø 14	32	80	80
NCD(S)4P80-160	48	100	80	10	10	125	360	180	225	193	165	65	125	95	320	250	110	260	ø 14	ø 14	24	50	100
NCD(S)4P80-200	80	100	80	10	10	125	470	180	250	194	170	65	125	95	345	280	110	340	ø 14	ø 14	32	80	100
NCD(S)4P80-250	92	100	80	10	10	125	470	200	280	210	191	80	160	120	400	315	110	340	ø 18	ø 14	32	80	100
NCD(S)4P80-315	128	100	80	10	10	125	470	250	315	232	220	80	160	120	400	315	110	340	ø 18	ø 14	32	80	100
NCD(S)4P80-400	184	100	80	10	10	125	530	280	355	268	268	80	160	120	435	355	110	370	ø 18	ø 14	42	110	100
NCD(S)4P100-200	83	125	100	10	10	125	470	200	280	212	180	80	160	120	360	280	110	340	ø 18	ø 14	32	80	125
NCD(S)4P100-250	103	125	100	10	10	140	470	225	280	233	205	80	160	120	400	315	110	340	ø 18	ø 14	32	80	125
NCD(S)4P100-315	138	125	100	10	10	140	470	250	315	250	230	80	160	120	400	315	110	340	ø 18	ø 14	32	80	125

Overall dimensions and weights
 Dimensions d'encombrement et poids
 Dimensioni di ingombro e pesi

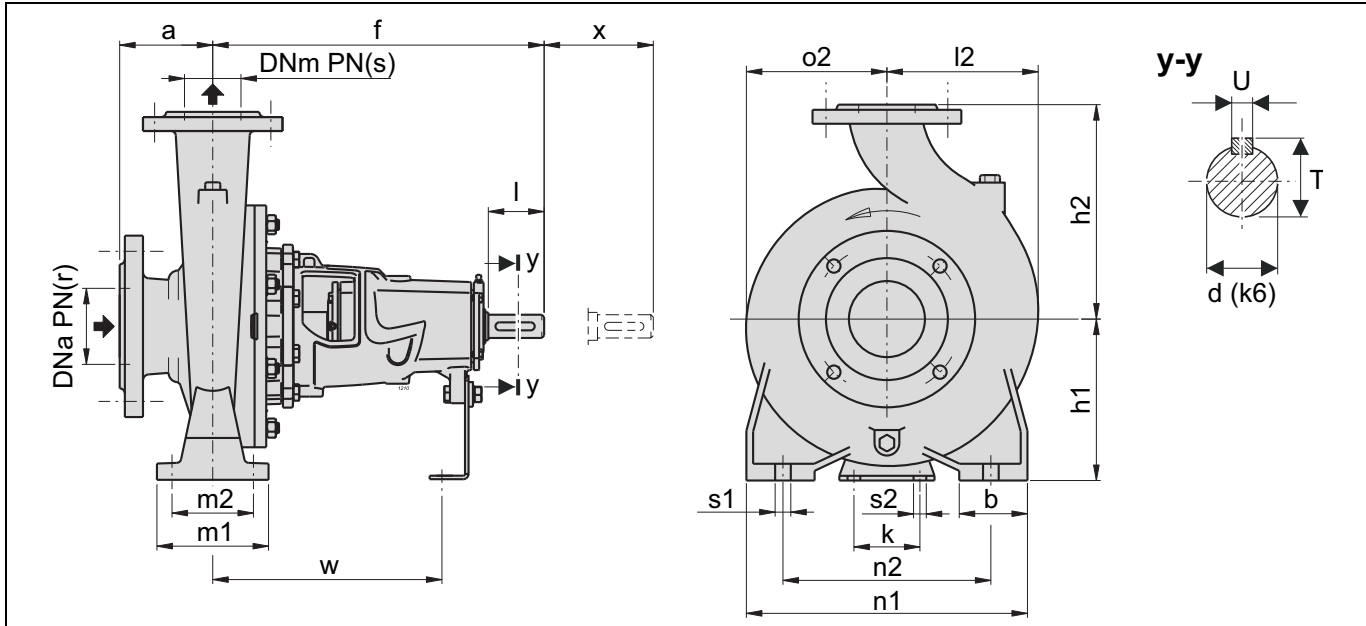

Type Type Tipo	Weight Poids Peso [kg]	Dimensions pump Dimensions pompe Dimensioni pompa										Duck foot pedestal dimensions Dimensions pieds de soutien Dimensioni piedi di appoggio										Shaft projection Saillie d'arbre Sporgenza d'albero		
		DNa	DNm	r	s	a	f	h1	h2	l2	o2	b	m1	m2	n1	n2	k	w	s1	s2	d	l	T	
		[mm]																						
NCD(S)4P100-400	199	125	100	10	10	140	530	280	355	280	268	100	200	150	500	400	110	370	ø 22	ø 14	42	110	125	
NCD(S)4P125-250	125	150	125	10	10	140	470	250	355	268	235	80	160	120	400	315	110	340	ø 18	ø 14	32	80	150	
NCD(S)4P125-315	189	150	125	10	10	140	530	280	355	278	247	100	200	150	500	400	110	370	ø 22	ø 14	42	110	150	
NCD(S)4P125-400	221	150	125	10	10	140	530	315	400	305	280	100	200	150	500	400	110	370	ø 22	ø 14	42	110	150	
NCD(S)4P150-315	200	200	150	10	10	160	530	280	400	298	260	100	200	150	550	450	110	370	ø 22	ø 14	42	110	200	
NCD(S)4P150-400	246	200	150	10	10	160	530	315	450	328	295	100	200	150	550	450	110	370	ø 22	ø 14	42	110	200	

Selection - dimensions and weights for base mounted electric pumps
 Sélection - dimensions et poids des électropompes sur socle
 Selezione - dimensioni e pesi elettropompe su base

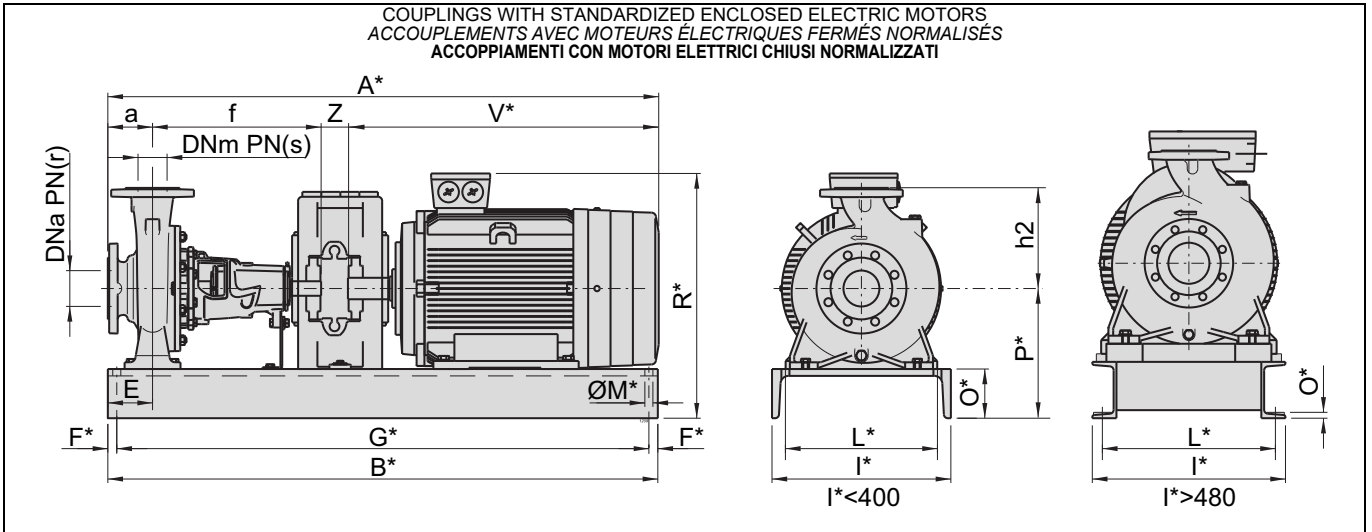

Pump Pompe Pompa		Motor Moteur Motore		Weight Poids Peso	BGAD	A *	B *	E	F *	G *	I *	L *	M *	O *	P *	R *	V *	Z	a	f	h2	r	s		
Type Type Tipo	DNa [mm]	DNm [mm]	[kW]	Size Taille Grand.	[kg]	Type Type Tipo	[mm]																		
NCD2P32-125	50	32	1,1	80M2	68	1002	773	780	90	15	750	240	180	∅ 14	85	197	322	295	38	80	360	140	10	10	
NCD2P32-125	50	32	1,5	90S2	72	1003	833	780	90	15	750	240	180	∅ 14	85	197	335	355	38	80	360	140	10	10	
NCD2P32-160	50	32	2,2	90L2	81	1004	863	780	90	15	750	240	180	∅ 14	85	217	355	385	38	80	360	160	10	10	
NCD2P32-160	50	32	3	100L2	107	1006	894	880	90	15	850	300	240	∅ 14	100	232	382	405	49	80	360	160	10	10	
NCD2P32L-160	50	32	4	112M2	107	1007	929	880	90	15	850	300	240	∅ 14	100	232	404	440	49	80	360	160	10	10	
NCD2P32-200	50	32	4	112M2	115	1012	929	880	90	15	850	300	240	∅ 14	100	260	432	440	49	80	360	180	10	10	
NCD2P32-200	50	32	5,5	132S2	151	1013	943	1020	100	15	990	350	290	∅ 14	100	260	452	455	48	80	360	180	10	10	
NCD2P32L-200	50	32	7,5	132S2	158	1013	943	1020	100	15	990	350	290	∅ 14	100	260	452	455	48	80	360	180	10	10	
NCD2P40-125	65	40	2,2	90L2	77	1015	863	780	90	15	750	240	180	∅ 14	85	197	335	385	38	80	360	140	10	10	
NCD2P40-160	65	40	4	112M2	109	1007	929	880	90	15	850	300	240	∅ 14	100	232	404	440	49	80	360	160	10	10	
NCD2P40-160	65	40	5,5	132S2	142	1017	943	1020	90	15	990	350	290	∅ 14	100	232	424	455	48	80	360	160	10	10	
NCD2P40-200	65	40	7,5	132S2	158	1019	963	1020	100	15	990	350	290	∅ 14	100	260	452	455	48	100	360	180	10	10	
NCD2P40-250	65	40	15	160M2	266	1021	1105	1020	100	15	990	350	290	∅ 14	100	280	531	627	18	100	360	225	10	10	
NCD2P50-125	65	50	4	112M2	110	1007	949	880	90	15	850	300	240	∅ 14	100	232	404	440	49	100	360	160	10	10	
NCD2P50-160	65	50	7,5	132S2	152	1019	963	1020	100	15	990	350	290	∅ 14	100	260	452	455	48	100	360	180	10	10	
NCD2P50-200	65	50	11	160M2	233	1024	1105	1020	100	15	990	350	290	∅ 14	100	260	511	627	18	100	360	200	10	10	
NCD2P50-250	65	50	18,5	160L2	280	1021	1105	1020	100	15	990	350	290	∅ 14	100	280	531	627	18	100	360	225	10	10	
NCD2P65-125	80	65	7,5	132S2	157	1019	963	1020	100	15	990	350	290	∅ 14	100	260	452	455	48	100	360	180	10	10	
NCD2P65-160	80	65	15	160M2	241	1024	1105	1020	100	15	990	350	290	∅ 14	100	260	511	627	18	100	360	200	10	10	
NCD2P65-200	80	65	22	180M2	315	1026	1185	1140	100	15	1110	350	290	∅ 14	100	280	550	665	60	100	360	225	10	10	
NCD2P65-250	80	65	37	200L2	470	1031	1365	1360	130	20	1320	400	340	∅ 18	110	310	610	738	57	100	470	250	10	10	
NCD2P80-160	100	80	18,5	160L2	270	1021	1130	1020	100	15	990	350	290	∅ 14	100	280	531	627	18	125	360	225	10	10	
NCD2P80-250	100	80	55	250M2	611	1042	1492	1250	95	205	840	480	430	∅ 24	16	415	790	870	27	125	470	280	10	10	
NCD2P100-200	125	100	45	225M2	507	1050	1427	1250	95	205	840	480	430	∅ 24	16	385	715	775	57	125	470	280	10	10	
NCD2P100-250	125	100	75	280S2	834	1052	1637	1400	95	230	940	510	450	∅ 24	17,5	505	900	1000	27	140	470	280	10	10	

BGAD = Base and coupling BGAD = Socle et accouplement BGAD = Base e giunto
 * = Indicatives values according to the type of motor installed. * = Valeurs indicatives en fonction de la marque du moteur utilisé. * = Valori indicativi in funzione della marca di motore utilizzato.
 ○ Motor in IE4 efficiency class according to EU REGULATION 2019/1781. Available in other efficiency classes for non-EU markets. ○ Moteur en classe de rendement IE4 conformément au RÈGLEMENT UE2019/1781. Disponibilité en différentes classes de rendements pour les marchés hors UE. ○ Motore in classe di efficienza IE4 in conformità al REGOLAMENTO UE2019/1781. Disponibili in altre classi di efficienza per mercati extra UE.

Selection - dimensions and weights for base mounted electric pumps
 Sélection - dimensions et poids des électropompes sur socle
 Selezione - dimensioni e pesi elettropompe su base

COUPLINGS WITH STANDARDIZED ENCLOSED ELECTRIC MOTORS
 ACCOUPLEMENTS AVEC MOTEURS ÉLECTRIQUES FERMÉS NORMALISÉS
 ACCOPIAMENTI CON MOTORI ELETTRICI CHIUSI NORMALIZZATI

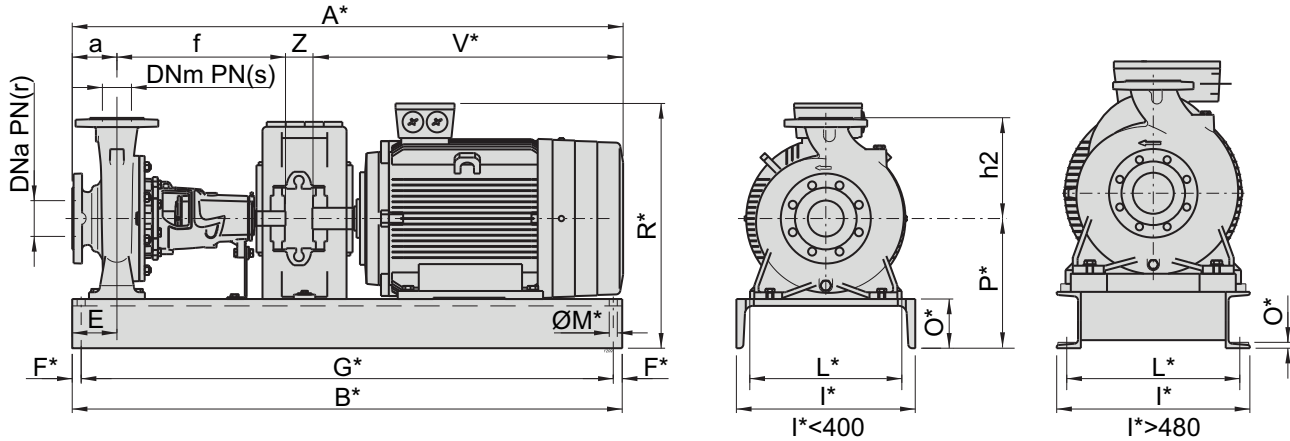

Pump Pompe Pompa		Motor Moteur Motore		Weight Poids Peso	BGAD	A *	B *	E	F *	G *	I *	L *	M *	O *	P *	R *	V *	Z	a	f	h2	r	s		
Type Type Tipo	DNa [mm]	DNm [mm]	[kW]	Size Taille Grand.	[kg]	Type Type Tipo	[mm]																		
NCDS2P32-125	50	32	1,1	80M2	68	1014	773	780	90	15	750	240	180	ø 14	85	197	322	295	38	80	360	140	10	10	
NCDS2P32-125	50	32	1,5	90S2	72	1015	833	780	90	15	750	240	180	ø 14	85	197	335	355	38	80	360	140	10	10	
NCDS2P32-160	50	32	2,2	90L2	81	1004	863	780	90	15	750	240	180	ø 14	85	217	355	385	38	80	360	160	10	10	
NCDS2P32-160	50	32	3	100L2	107	1006	894	880	90	15	850	300	240	ø 14	100	232	382	405	49	80	360	160	10	10	
NCDS2P32L-160	50	32	4	112M2	107	1007	929	880	90	15	850	300	240	ø 14	100	232	404	440	49	80	360	160	10	10	
NCDS2P32-200	50	32	4	112M2	114	1012	929	880	90	15	850	300	240	ø 14	100	260	432	440	49	80	360	180	10	10	
NCDS2P32-200	50	32	5,5	132S2	150	1013	943	1020	100	15	990	350	290	ø 14	100	260	452	455	48	80	360	180	10	10	
NCDS2P32L-200	50	32	7,5	132S2	158	1013	943	1020	100	15	990	350	290	ø 14	100	260	452	455	48	80	360	180	10	10	
NCDS2P40-125	65	40	2,2	90L2	76	1015	863	780	90	15	750	240	180	ø 14	85	197	335	385	38	80	360	140	10	10	
NCDS2P40-160	65	40	4	112M2	109	1007	929	880	90	15	850	300	240	ø 14	100	232	404	440	49	80	360	160	10	10	
NCDS2P40-160	65	40	5,5	132S2	142	1017	943	1020	90	15	990	350	290	ø 14	100	232	424	455	48	80	360	160	10	10	
NCDS2P40-200	65	40	7,5	132S2	158	1019	963	1020	100	15	990	350	290	ø 14	100	260	452	455	48	100	360	180	10	10	
NCDS2P40-250	65	40	15	160M2	264	1021	1105	1020	100	15	990	350	290	ø 14	100	280	531	627	18	100	360	225	10	10	
NCDS2P50-125	65	50	4	112M2	110	1007	949	880	90	15	850	300	240	ø 14	100	232	404	440	49	100	360	160	10	10	
NCDS2P50-125	65	50	5,5	132S2	143	1017	963	1020	90	15	990	350	290	ø 14	100	232	424	455	48	100	360	160	10	10	
NCDS2P50-160	65	50	7,5	132S2	152	1019	963	1020	100	15	990	350	290	ø 14	100	260	452	455	48	100	360	180	10	10	
NCDS2P50-200	65	50	11	160M2	233	1024	1105	1020	100	15	990	350	290	ø 14	100	260	511	627	18	100	360	200	10	10	
NCDS2P50-250	65	50	18,5	160L2	279	1021	1105	1020	100	15	990	350	290	ø 14	100	280	531	627	18	100	360	225	10	10	
NCDS2P65-125	80	65	7,5	132S2	157	1019	963	1020	100	15	990	350	290	ø 14	100	260	452	455	48	100	360	180	10	10	
NCDS2P65-160	80	65	15	160M2	240	1024	1105	1020	100	15	990	350	290	ø 14	100	260	511	627	18	100	360	200	10	10	
NCDS2P65-200	80	65	22	180M2	315	1026	1185	1140	100	15	1110	350	290	ø 14	100	280	550	665	60	100	360	225	10	10	
NCDS2P65-250	80	65	37	200L2	469	1031	1365	1360	130	20	1320	400	340	ø 18	110	310	610	738	57	100	470	250	10	10	
NCDS2P80-160	100	80	18,5	160L2	270	1021	1130	1020	100	15	990	350	290	ø 14	100	280	531	627	18	125	360	225	10	10	
NCDS2P80-200	100	80	30	200L2	439	1038	1390	1360	130	20	1320	400	340	ø 18	110	310	610	738	57	125	470	250	10	10	
NCDS2P80-250	100	80	55	250M2	611	1042	1492	1250	95	205	840	480	430	ø 24	16	415	790	870	27	125	470	280	10	10	
NCDS2P100-200	125	100	45	225M2	506	1050	1427	1250	95	205	840	480	430	ø 24	16	385	715	775	57	125	470	280	10	10	
NCDS2P100-250	125	100	75	280S2	795	1052	1587	1400	95	230	940	510	450	ø 24	17,5	505	895	950	27	140	470	280	10	10	

BGAD = Base and coupling

BGAD = Socle et accouplement

BGAD = Base e giunto

* = Indicatives values according to the type of motor installed.

* = Valeurs indicatives en fonction de la marque du moteur utilisé.

* = Valori indicativi in funzione della marca di motore utilizzato.

Selection - dimensions and weights for base mounted electric pumps
 Sélection - dimensions et poids des électropompes sur socle
 Selezione - dimensioni e pesi elettropompe su base

COUPLINGS WITH STANDARDIZED ENCLOSED ELECTRIC MOTORS
 ACCOUPLEMENTS AVEC MOTEURS ÉLECTRIQUES FERMÉS NORMALISÉS
 ACCOPIAMENTI CON MOTORI ELETTRICI CHIUSI NORMALIZZATI

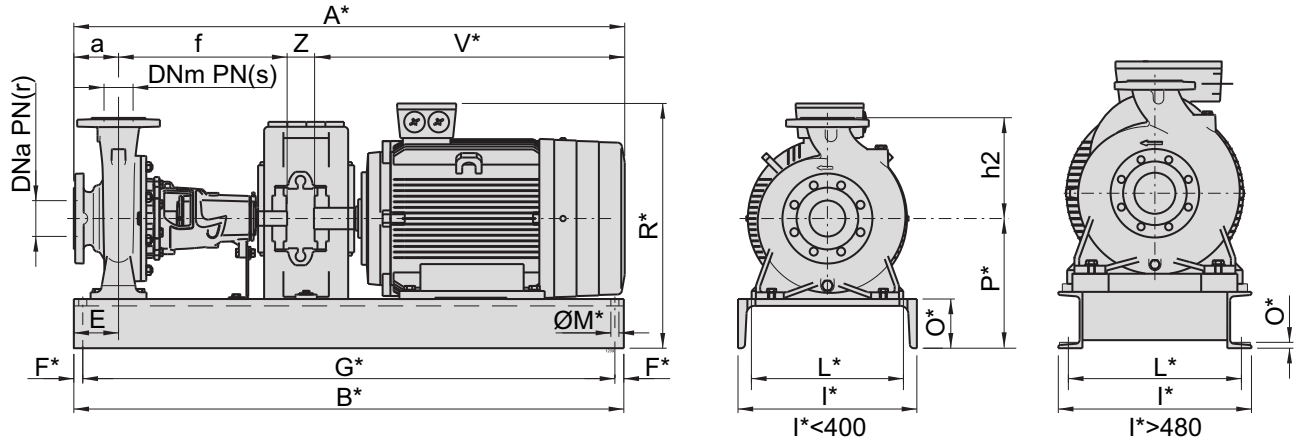

Pump Pompe Pompa		Motor Moteur Motore		Weight Poids Peso	BGAD	A *	B *	E	F *	G *	I *	L *	M *	O *	P *	R *	V *	Z	a	f	h2	r	s		
Type Type Tipo	DNa [mm]	DNm	[kW]	Size Taille Grand.	[kg]	Type Type Tipo	[mm]																		
NCD4P32-200	50	32	0,75	80M4	80	1011	773	780	90	15	750	240	180	∅ 14	85	245	370	295	38	80	360	180	10	10	
NCD4P40-160	65	40	0,75	80M4	75	1016	773	780	90	15	750	240	180	∅ 14	85	217	342	295	38	80	360	160	10	10	
NCD4P40-200	65	40	1,1	90S4	101	1020	853	880	100	15	850	300	240	∅ 14	100	260	398	355	38	100	360	180	10	10	
NCD4P40-250	65	40	3	100L4	146	1023	914	880	100	15	850	350	290	∅ 14	100	280	430	405	49	100	360	225	10	10	
NCD4P50-125	65	50	0,75	112M2	76	1016	793	780	90	15	750	240	180	∅ 14	85	217	342	295	38	100	360	160	10	10	
NCD4P50-160	65	50	1,1	90S4	95	1020	853	880	100	15	850	300	240	∅ 14	100	260	398	355	38	100	360	180	10	10	
NCD4P50-200	65	50	2,2	100L4	118	1009	914	880	90	15	850	300	240	∅ 14	100	260	410	405	49	100	360	200	10	10	
NCD4P50-250	65	50	4	112M4	157	1025	949	880	100	15	850	350	290	∅ 14	100	280	452	440	49	100	360	225	10	10	
NCD4P65-125	80	65	1,1	90S4	99	1020	853	880	100	15	850	300	240	∅ 14	100	260	398	355	38	100	360	180	10	10	
NCD4P65-160	80	65	1,5	90L4	105	1020	883	880	100	15	850	300	240	∅ 14	100	260	398	385	38	100	360	200	10	10	
NCD4P65-200	80	65	3	100L4	139	1023	914	880	100	15	850	350	290	∅ 14	100	280	430	405	49	100	360	225	10	10	
NCD4P65-250	80	65	5,5	132S4	220	1032	1045	1030	130	20	990	400	340	∅ 18	110	310	502	455	20	100	470	250	10	10	
NCD4P65-315	80	65	11	160M4	373	1034	1226	1230	130	20	1190	400	340	∅ 18	110	335	586	627	4	125	470	280	10	10	
NCD4P80-160	100	80	2,2	100L4	135	1023	939	880	100	15	850	350	290	∅ 14	100	280	430	405	49	125	360	225	10	10	
NCD4P80-200	100	80	4	112M4	187	1039	1084	1020	100	15	990	350	290	∅ 14	100	280	452	440	49	125	470	250	10	10	
NCD4P80-250	100	80	7,5	132M4	231	1032	1105	1030	130	20	990	400	340	∅ 18	110	310	502	490	20	125	470	280	10	10	
NCD4P80-315	100	80	15	160L4	384	1043	1226	1230	130	20	1190	400	340	∅ 18	110	360	611	627	4	125	470	315	10	10	
NCD4P80-400	100	80	30	200L4	559	1046	1440	1250	115	205	840	480	430	∅ 24	16	445	745	758	27	125	530	355	10	10	
NCD4P100-200	125	100	5,5	132S4	214	1032	1070	1030	130	20	990	400	340	∅ 18	110	310	502	455	20	125	470	280	10	10	
NCD4P100-250	125	100	11	160M4	346	1034	1241	1230	130	20	1190	400	340	∅ 18	110	335	586	627	4	140	470	280	10	10	
NCD4P100-315	125	100	18,5	180M4	447	1044	1335	1360	130	20	1320	400	340	∅ 18	110	360	630	665	60	140	470	315	10	10	
NCD4P100-400	125	100	37	225S4	621	1055	1467	1250	115	205	840	480	430	∅ 24	16	445	775	793	4	140	530	355	10	10	
NCD4P125-250	150	125	15	160L4	380	1043	1241	1230	130	20	1190	400	340	∅ 18	110	360	611	627	4	140	470	355	10	10	
NCD4P125-315	150	125	30	200L4	563	1054	1455	1250	115	205	840	480	430	∅ 24	16	445	745	758	27	140	530	355	10	10	
NCD4P125-400	150	125	55	250M4	843	1058	1554	1400	115	230	940	510	450	∅ 24	17,5	540	915	880	4	140	530	400	10	10	
NCD4P150-315	200	150	37	225S4	623	1061	1487	1250	115	205	840	480	430	∅ 24	16	445	775	793	4	160	530	400	10	10	
NCD4P150-400	200	150	75	280S4	1040	1064	1707	1400	115	230	940	510	450	∅ 24	17,5	540	935	1013	4	160	530	450	10	10	

BGAD = Base and coupling
 * = Indicatives values according to the type of motor installed.
 ○ Motor in IE4 efficiency class according to EU REGULATION 2019/1781. Available in other efficiency classes for non-EU markets.

BGAD = Socle et accouplement
 * = Valeurs indicatives en fonction de la marque du moteur utilisé.
 ○ Moteur en classe de rendement IE4 conformément au RÈGLEMENT UE2019/1781. Disponibilit  en diff rentes classes de rendement pour les march s hors UE.

BGAD = Base e giunto
 * = Valori indicativi in funzione della marca di motore utilizzato.
 ○ Motore in classe di efficienza IE4 in conformit  al REGOLAMENTO UE2019/1781. Disponibili in altre classi di efficienza per mercati extra UE.

Selection - dimensions and weights for base mounted electric pumps
 Sélection - dimensions et poids des électropompes sur socle
 Selezione - dimensioni e pesi elettropompe su base

COUPLINGS WITH STANDARDIZED ENCLOSED ELECTRIC MOTORS
 ACCOUPLEMENTS AVEC MOTEURS ÉLECTRIQUES FERMÉS NORMALISÉS
 ACCOPIAMENTI CON MOTORI ELETTRICI CHIUSI NORMALIZZATI

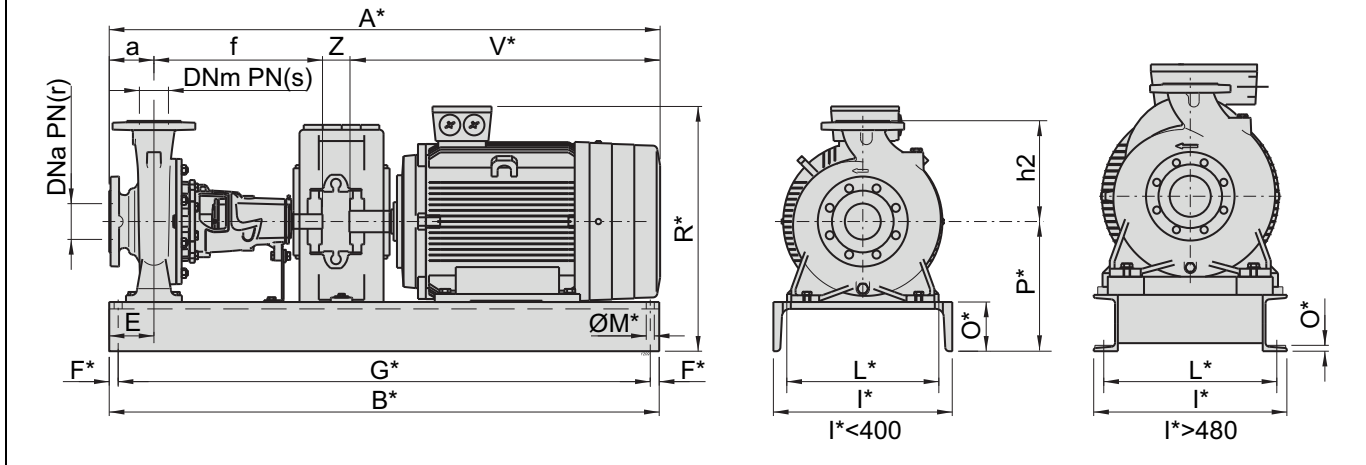

Pump Pompe Pompa		Motor Moteur Motore		Weight Poids Peso	BGAD	A*	B*	E	F*	G*	I*	L*	M*	O*	P*	R*	V*	Z	a	f	h2	r	s		
Type Type Tipo	DNa [mm]	DNm [mm]	[kW]	Size Taille Grand.	[kg]	Type Type Tipo	[mm]																		
NCDS4P32-200	50	32	0,75	80M4	81	1011	773	780	90	15	750	240	180	ø 14	85	245	370	295	38	80	360	180	10	10	
NCDS4P40-160	65	40	0,75	80M4	75	1016	773	780	90	15	750	240	180	ø 14	85	217	342	295	38	80	360	160	10	10	
NCDS4P40-200	65	40	1,1	90S4	101	1020	853	880	100	15	850	300	240	ø 14	100	260	398	355	38	100	360	180	10	10	
NCDS4P40-250	65	40	3	100L4	146	1023	914	880	100	15	850	350	290	ø 14	100	280	430	405	49	100	360	225	10	10	
NCDS4P50-160	65	50	1,1	90S4	95	1020	853	880	100	15	850	300	240	ø 14	100	260	398	355	38	100	360	180	10	10	
NCDS4P50-200	65	50	2,2	100L4	118	1009	914	880	90	15	850	300	240	ø 14	100	260	410	405	49	100	360	200	10	10	
NCDS4P50-250	65	50	4	112M4	155	1025	949	880	100	15	850	350	290	ø 14	100	280	452	440	49	100	360	225	10	10	
NCDS4P65-125	80	65	1,1	90S4	99	1020	853	880	100	15	850	300	240	ø 14	100	260	398	355	38	100	360	180	10	10	
NCDS4P65-160	80	65	1,5	90L4	105	1020	883	880	100	15	850	300	240	ø 14	100	260	398	385	38	100	360	200	10	10	
NCDS4P65-200	80	65	3	100L4	139	1023	914	880	100	15	850	350	290	ø 14	100	280	430	405	49	100	360	225	10	10	
NCDS4P65-250	80	65	5,5	132S4	220	1032	1045	1030	130	20	990	400	340	ø 18	110	310	502	455	20	100	470	250	10	10	
NCDS4P65-315	80	65	11	160M4	372	1034	1226	1230	130	20	1190	400	340	ø 18	110	335	586	627	4	125	470	280	10	10	
NCDS4P80-160	100	80	2,2	100L4	135	1023	939	880	100	15	850	350	290	ø 14	100	280	430	405	49	125	360	225	10	10	
NCDS4P80-200	100	80	4	112M4	188	1039	1084	1020	100	15	990	350	290	ø 14	100	280	452	440	49	125	470	250	10	10	
NCDS4P80-250	100	80	7,5	132M4	230	1032	1105	1030	130	20	990	400	340	ø 18	110	310	502	490	20	125	470	280	10	10	
NCDS4P80-315	100	80	15	160L4	384	1043	1226	1230	130	20	1190	400	340	ø 18	110	360	611	627	4	125	470	315	10	10	
NCDS4P80-400	100	80	30	200L4	559	1046	1440	1250	115	205	840	480	430	ø 24	16	445	745	758	27	125	530	355	10	10	
NCDS4P100-200	125	100	5,5	132S4	214	1032	1070	1030	130	20	990	400	340	ø 18	110	310	502	455	20	125	470	280	10	10	
NCDS4P100-250	125	100	11	160M4	346	1034	1241	1230	130	20	1190	400	340	ø 18	110	335	586	627	4	140	470	280	10	10	
NCDS4P100-315	125	100	18,5	180M4	444	1044	1335	1360	130	20	1320	400	340	ø 18	110	360	630	665	60	140	470	315	10	10	
NCDS4P100-400	125	100	37	225S4	619	1055	1467	1250	115	205	840	480	430	ø 24	16	445	775	793	4	140	530	355	10	10	
NCDS4P125-250	150	125	15	160L4	377	1043	1241	1230	130	20	1190	400	340	ø 18	110	360	611	627	4	140	470	355	10	10	
NCDS4P125-315	150	125	30	200L4	561	1054	1455	1250	115	205	840	480	430	ø 24	16	445	745	758	27	140	530	355	10	10	
NCDS4P125-400	150	125	55	250M4	843	1058	1554	1400	115	230	940	510	450	ø 24	17,5	540	915	880	4	140	530	400	10	10	
NCDS4P150-315	200	150	37	225S4	623	1061	1487	1250	115	205	840	480	430	ø 24	16	445	775	793	4	160	530	400	10	10	
NCDS4P150-400	200	150	75	280S4	936	1064	1714	1400	115	230	940	510	450	ø 24	17,5	540	930	1020	4	160	530	450	10	10	

BGAD = Base and coupling

* = Indicatives values according to the type of motor installed.

BGAD = Socle et accouplement

* = Valeurs indicatives en fonction de la marque du moteur utilisé.

BGAD = Base e giunto

* = Valori indicativi in funzione della marca di motore utilizzato.

Flanges (UNI EN 1092-2)
 Brides (UNI EN 1092-2)
 Flange (UNI EN 1092-2)

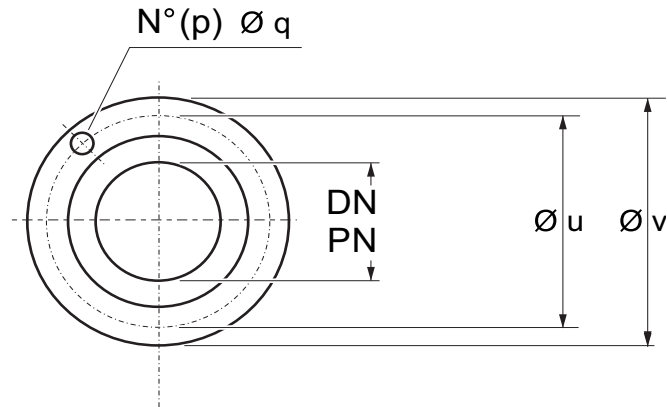

Port \varnothing \varnothing Orifice \varnothing Bocca		Holes Trous Fori		$\varnothing u$	$\varnothing v$
DN [mm]	PN [bar]	p No	q \varnothing [mm]	[mm]	
32	10	4	19	100	140
40	10	4	19	110	150
50	10	4	19	125	165
65	10	4	19	145	185
80	10	8	19	160	200
100	10	8	19	180	220
125	10	8	19	210	250
150	10	8	23	240	285
200	10	8	23	295	340

caprari

The dimensions have an indicative value. Executive drawing will be supplied on request upon order.
CAPRARI S.p.A. reserves the right to make changes to improve its products at any time and without any notice

*Les dimensions sont fournies à titre indicatif. Le plan bon pour exécution sera fourni sur demande au moment de la commande.
CAPRARI S.p.A. se réserve la faculté d'apporter des modifications visant à améliorer ses propres produits à tout moment et sans aucun préavis.*

**Le dimensioni hanno valore indicativo. Il disegno esecutivo sarà fornito su richiesta in fase d'ordine.
CAPRARI S.p.A. si riserva facoltà di apportare modifiche atte a migliorare i propri prodotti in qualsiasi momento e senza preavviso alcuno.**