

NCDS 2P40-125

3450 n [min⁻¹]

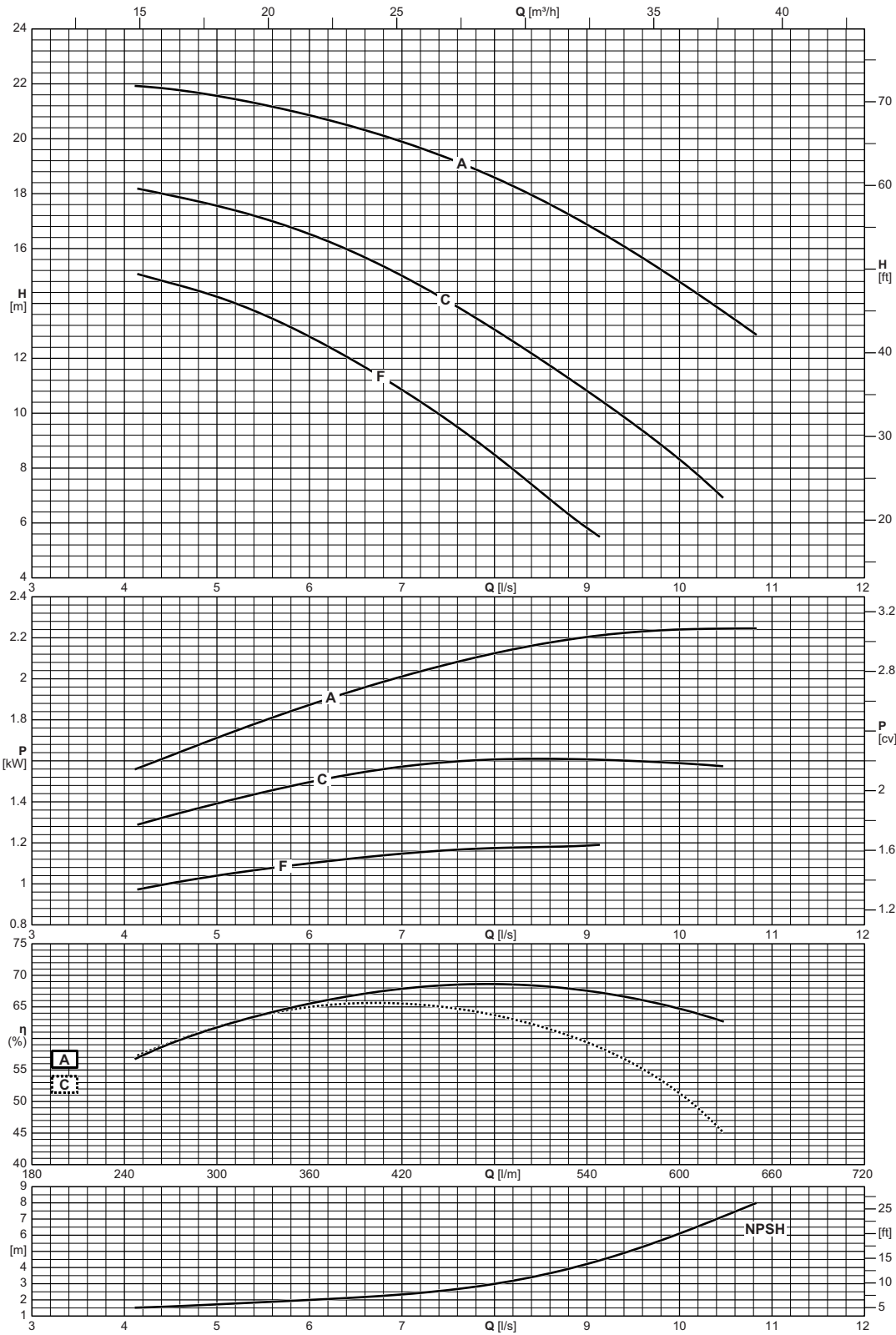

Operating data
Caracteristiques de fonctionnement
Caratteristiche di funzionamento



Type Type Tipo	Inlet maximum pressure Pression maximale en aspiration Pressione massima in aspirazione
NCDS2P40-125	[bar]
	10

Overall dimensions and weights
 Dimensions d'encombrement et poids
 Dimensioni di ingombro e pesi



Type Type Tipo	Weight Poids Peso [kg]	Dimensions pump Dimensions pompe Dimensioni pompa										Duck foot pedestal dimensions Dimensiones pieds de soutien Dimensioni piedi di appoggio							Shaft projection Saillie d'arbre Sporgenza d'albero				
		DNa	DNm	r	s	a	f	h1	h2	l2	o2	b	m1	m2	n1	n2	k	w	s1	s2	d	l	T
		[mm]																					
NCD(S)2P32-125	26	50	32	10	10	80	360	112	140	97	93	50	100	70	190	140	110	260	ø 14	ø 14	24	50	50
NCD(S)2P32-160	33	50	32	10	10	80	360	132	160	120	120	50	100	70	240	190	110	260	ø 14	ø 14	24	50	50
NCD(S)2P32L-160	31	50	32	10	10	80	360	132	160	120	120	50	100	70	240	190	110	260	ø 14	ø 14	24	50	50
NCD(S)2P32L-200	40	50	32	10	10	80	360	160	180	140	140	50	100	70	265	212	110	260	ø 14	ø 14	24	50	50
NCD(S)2P32-200	38	50	32	10	10	80	360	160	180	140	140	50	100	70	240	190	110	260	ø 14	ø 14	24	50	50
NCD(S)2P40-125	28	65	40	10	10	80	360	112	140	113	100	50	100	70	210	160	110	260	ø 14	ø 14	24	50	65
NCD(S)2P40-160	33	65	40	10	10	80	360	132	160	119	119	50	100	70	240	190	110	260	ø 14	ø 14	24	50	65
NCD(S)2P40-200	40	65	40	10	10	100	360	160	180	140	140	50	100	70	265	212	110	260	ø 14	ø 14	24	50	65
NCD(S)2P40-250	55	65	40	10	10	100	360	180	225	175	175	65	125	95	320	250	110	260	ø 14	ø 14	24	50	65
NCD(S)2P50-125	34	65	50	10	10	100	360	132	160	137	121	50	100	70	240	190	110	260	ø 14	ø 14	24	50	65
NCD(S)2P50-160	33	65	50	10	10	100	360	160	180	141	127	50	100	70	265	212	110	260	ø 14	ø 14	24	50	65
NCD(S)2P50-200	44	65	50	10	10	100	360	160	200	153	140	50	100	70	265	212	110	260	ø 14	ø 14	24	50	65
NCD(S)2P50-250	57	65	50	10	10	100	360	180	225	175	175	65	125	95	320	250	110	260	ø 14	ø 14	24	50	65
NCD(S)2P65-125	38	80	65	10	10	100	360	160	180	155	134	65	125	95	280	212	110	260	ø 14	ø 14	24	50	80
NCD(S)2P65-160	40	80	65	10	10	100	360	160	200	172	150	65	125	95	280	212	110	260	ø 14	ø 14	24	50	80
NCD(S)2P65-200	48	80	65	10	10	100	360	180	225	175	155	65	125	95	320	250	110	260	ø 14	ø 14	24	50	80
NCD(S)2P65-250	88	80	65	10	10	100	470	200	250	190	175	80	160	120	360	280	110	340	ø 18	ø 14	24	50	80
NCD(S)2P80-160	48	100	80	10	10	125	360	180	225	193	165	65	125	95	320	250	110	260	ø 14	ø 14	24	50	100
NCD(S)2P80-200	80	100	80	10	10	125	470	180	250	194	170	65	125	95	345	280	110	340	ø 14	ø 14	32	80	100
NCD(S)2P80-250	92	100	80	10	10	125	470	200	280	210	191	80	160	120	400	315	110	340	ø 18	ø 14	32	80	100
NCD(S)2P100-200	83	125	100	10	10	125	470	200	280	212	180	80	160	120	360	280	110	340	ø 18	ø 14	32	80	125
NCD(S)2P100-250	103	125	100	10	10	140	470	225	280	233	205	80	160	120	400	315	110	340	ø 18	ø 14	32	80	125
NCD(S)4P32-125	25	50	32	10	10	80	360	112	140	97	93	50	100	70	190	140	110	260	ø 14	ø 14	24	50	50
NCD(S)4P32-160	33	50	32	10	10	80	360	132	160	120	120	50	100	70	240	190	110	260	ø 14	ø 14	24	50	50
NCD(S)4P32-200	37	50	32	10	10	80	360	160	180	140	140	50	100	70	240	190	110	260	ø 14	ø 14	24	50	50
NCD(S)4P40-160	33	65	40	10	10	80	360	132	160	119	119	50	100	70	240	190	110	260	ø 14	ø 14	24	50	65
NCD(S)4P40-200	40	65	40	10	10	100	360	160	180	140	140	50	100	70	265	212	110	260	ø 14	ø 14	24	50	65
NCD(S)4P40-250	55	65	40	10	10	100	360	180	225	175	175	65	125	95	320	250	110	260	ø 14	ø 14	24	50	65
NCD(S)4P50-125	34	65	50	10	10	100	360	132	160	137	121	50	100	70	240	190	110	260	ø 14	ø 14	24	50	65
NCD(S)4P50-160	33	65	50	10	10	100	360	160	180	141	127	50	100	70	265	212	110	260	ø 14	ø 14	24	50	65
NCD(S)4P50-200	44	65	50	10	10	100	360	160	200	153	140	50	100	70	265	212	110	260	ø 14	ø 14	24	50	65
NCD(S)4P50-250	57	65	50	10	10	100	360	180	225	175	175	65	125	95	320	250	110	260	ø 14	ø 14	24	50	65
NCD(S)4P65-125	38	80	65	10	10	100	360	160	180	155	134	65	125	95	280	212	110	260	ø 14	ø 14	24	50	80
NCD(S)4P65-160	40	80	65	10	10	100	360	160	200	172	150	65	125	95	280	212	110	260	ø 14	ø 14	24	50	80
NCD(S)4P65-200	48	80	65	10	10	100	360	180	225	175	155	65	125	95	320	250	110	260	ø 14	ø 14	24	50	80
NCD(S)4P65-250	89	80	65	10	10	100	470	200	250	190	175	80	160	120	360	280	110	340	ø 18	ø 14	24	50	80
NCD(S)4P65-315	131	80	65	10	10	125	470	225	280	220	220	80	160	120	400	315	110	340	ø 18	ø 14	32	80	80
NCD(S)4P80-160	48	100	80	10	10	125	360	180	225	193	165	65	125	95	320	250	110	260	ø 14	ø 14	24	50	100
NCD(S)4P80-200	80	100	80	10	10	125	470	180	250	194	170	65	125	95	345	280	110	340	ø 14	ø 14	32	80	100
NCD(S)4P80-250	92	100	80	10	10	125	470	200	280	210	191	80	160	120	400	315	110	340	ø 18	ø 14	32	80	100
NCD(S)4P80-315	128	100	80	10	10	125	470	250	315	232	220	80	160	120	400	315	110	340	ø 18	ø 14	32	80	100
NCD(S)4P80-400	184	100	80	10	10	125	530	280	355	268	268	80	160	120	435	355	110	370	ø 18	ø 14	42	110	100
NCD(S)4P100-200	83	125	100	10	10	125	470	200	280	212	180	80	160	120	360	280	110	340	ø 18	ø 14	32	80	125
NCD(S)4P100-250	103	125	100	10	10	140	470	225	280	233	205	80	160	120	400	315	110	340	ø 18	ø 14	32	80	125
NCD(S)4P100-315	138	125	100	10	10	140	470	250	315	250	230	80	160	120	400	315	110	340	ø 18	ø 14	32	80	125

Selection - dimensions and weights for base mounted electric pumps
 Sélection - dimensions et poids des électropompes sur socle
 Selezione - dimensioni e pesi elettropompe su base

COUPLINGS WITH STANDARDIZED ENCLOSED ELECTRIC MOTORS
 ACCOUPLEMENTS AVEC MOTEURS ÉLECTRIQUES FERMÉS NORMALISÉS
 ACCOPIAMENTI CON MOTORI ELETTRICI CHIUSI NORMALIZZATI

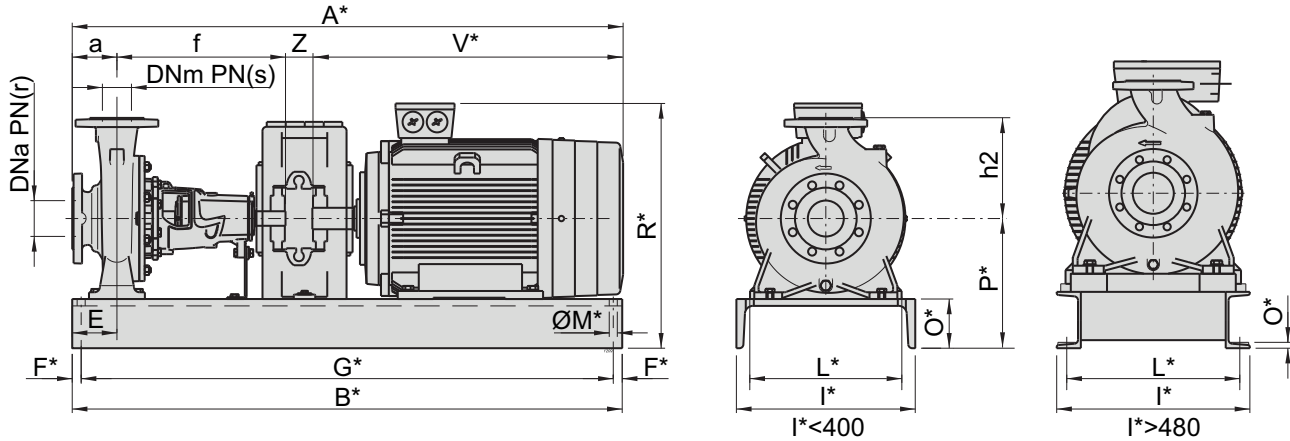

Pump Pompe Pompa		Motor Moteur Motore		Weight Poids Peso	BGAD	A*	B*	E	F*	G*	I*	L*	M*	O*	P*	R*	V*	Z	a	f	h2	r	s		
Type Type Tipo	DNa [mm]	DNm [mm]	[kW]	Size Taille Grand.	[kg]	Type Type Tipo	[mm]																		
NCDS2P32-125	50	32	1,1	80M2	68	1014	773	780	90	15	750	240	180	ø 14	85	197	322	295	38	80	360	140	10	10	
NCDS2P32-125	50	32	1,5	90S2	72	1015	833	780	90	15	750	240	180	ø 14	85	197	335	355	38	80	360	140	10	10	
NCDS2P32-160	50	32	2,2	90L2	81	1004	863	780	90	15	750	240	180	ø 14	85	217	355	385	38	80	360	160	10	10	
NCDS2P32-160	50	32	3	100L2	107	1006	894	880	90	15	850	300	240	ø 14	100	232	382	405	49	80	360	160	10	10	
NCDS2P32L-160	50	32	4	112M2	107	1007	929	880	90	15	850	300	240	ø 14	100	232	404	440	49	80	360	160	10	10	
NCDS2P32-200	50	32	4	112M2	114	1012	929	880	90	15	850	300	240	ø 14	100	260	432	440	49	80	360	180	10	10	
NCDS2P32-200	50	32	5,5	132S2	150	1013	943	1020	100	15	990	350	290	ø 14	100	260	452	455	48	80	360	180	10	10	
NCDS2P32L-200	50	32	7,5	132S2	158	1013	943	1020	100	15	990	350	290	ø 14	100	260	452	455	48	80	360	180	10	10	
NCDS2P40-125	65	40	2,2	90L2	76	1015	863	780	90	15	750	240	180	ø 14	85	197	335	385	38	80	360	140	10	10	
NCDS2P40-160	65	40	4	112M2	109	1007	929	880	90	15	850	300	240	ø 14	100	232	404	440	49	80	360	160	10	10	
NCDS2P40-160	65	40	5,5	132S2	142	1017	943	1020	90	15	990	350	290	ø 14	100	232	424	455	48	80	360	160	10	10	
NCDS2P40-200	65	40	7,5	132S2	158	1019	963	1020	100	15	990	350	290	ø 14	100	260	452	455	48	100	360	180	10	10	
NCDS2P40-250	65	40	15	160M2	264	1021	1105	1020	100	15	990	350	290	ø 14	100	280	531	627	18	100	360	225	10	10	
NCDS2P50-125	65	50	4	112M2	110	1007	949	880	90	15	850	300	240	ø 14	100	232	404	440	49	100	360	160	10	10	
NCDS2P50-125	65	50	5,5	132S2	143	1017	963	1020	90	15	990	350	290	ø 14	100	232	424	455	48	100	360	160	10	10	
NCDS2P50-160	65	50	7,5	132S2	152	1019	963	1020	100	15	990	350	290	ø 14	100	260	452	455	48	100	360	180	10	10	
NCDS2P50-200	65	50	11	160M2	233	1024	1105	1020	100	15	990	350	290	ø 14	100	260	511	627	18	100	360	200	10	10	
NCDS2P50-250	65	50	18,5	160L2	279	1021	1105	1020	100	15	990	350	290	ø 14	100	280	531	627	18	100	360	225	10	10	
NCDS2P65-125	80	65	7,5	132S2	157	1019	963	1020	100	15	990	350	290	ø 14	100	260	452	455	48	100	360	180	10	10	
NCDS2P65-160	80	65	15	160M2	240	1024	1105	1020	100	15	990	350	290	ø 14	100	260	511	627	18	100	360	200	10	10	
NCDS2P65-200	80	65	22	180M2	315	1026	1185	1140	100	15	1110	350	290	ø 14	100	280	550	665	60	100	360	225	10	10	
NCDS2P65-250	80	65	37	200L2	469	1031	1365	1360	130	20	1320	400	340	ø 18	110	310	610	738	57	100	470	250	10	10	
NCDS2P80-160	100	80	18,5	160L2	270	1021	1130	1020	100	15	990	350	290	ø 14	100	280	531	627	18	125	360	225	10	10	
NCDS2P80-200	100	80	30	200L2	439	1038	1390	1360	130	20	1320	400	340	ø 18	110	310	610	738	57	125	470	250	10	10	
NCDS2P80-250	100	80	55	250M2	611	1042	1492	1250	95	205	840	480	430	ø 24	16	415	790	870	27	125	470	280	10	10	
NCDS2P100-200	125	100	45	225M2	506	1050	1427	1250	95	205	840	480	430	ø 24	16	385	715	775	57	125	470	280	10	10	
NCDS2P100-250	125	100	75	280S2	795	1052	1587	1400	95	230	940	510	450	ø 24	17,5	505	895	950	27	140	470	280	10	10	

BGAD = Base and coupling

* = Indicatives values according to the type of motor installed.

BGAD = Socle et accouplement

* = Valeurs indicatives en fonction de la marque du moteur utilisé.

BGAD = Base e giunto

* = Valori indicativi in funzione della marca di motore utilizzato.