

Utilization field Champ d'utilisation Campo di utilizzo ≥ 65% η		
Stage number: compatibly with the maximum pressure. Nombre d'étages: compatible avec la pression maximum. Numero stadi: compatibilmente con la pressione massima di esercizio.		
Type Type Tipo	MIN.	MAX.
PM	2	16
PMS	2	16
PMH	5	16
NB. For two-stage pumps only, reduce efficiency by one point. Diminuer le rendement d'un point seulement pour les pompes à deux étages. Solamente per le pompe a due stadi, ridurre di un punto il rendimento.		

Wet moment of inertia J Moment d'inertie J mouillé Momento d'inertzia J bagnato J=¼PD ² - [kg m ²]		
Impeller type Roue type Girante tipo	PM(S/H)80/1	For each additional stage Pour chaque étage en plus Per ogni stadio in più
Cast iron Fonte Ghisa	0,0207	0,0170
Bronze Bronze Bronzo	0,0229	0,0188

Maximum permissible power Puissances maximums admissibles Massime potenze ammissibili	
Type Type Tipo	N/n MAX.
PM	0,06
PMS	0,06
PMH	0,1
For seal limits and calculation formulas of the maximum permissible powers, see technical data section. Consulter la section Données techniques pour connaître les limites des joints et les formules pour le calcul des puissances maximales admises. Per i limiti tenuta e le formule di calcolo delle massime potenze ammissibili, vedere sezione dati tecnici.	

PERFORMANCES EACH INTERMEDIATE STAGE
CARACTERISTIQUES POUR CHAQUE ETAGE
PRESTAZIONI PER STADIO

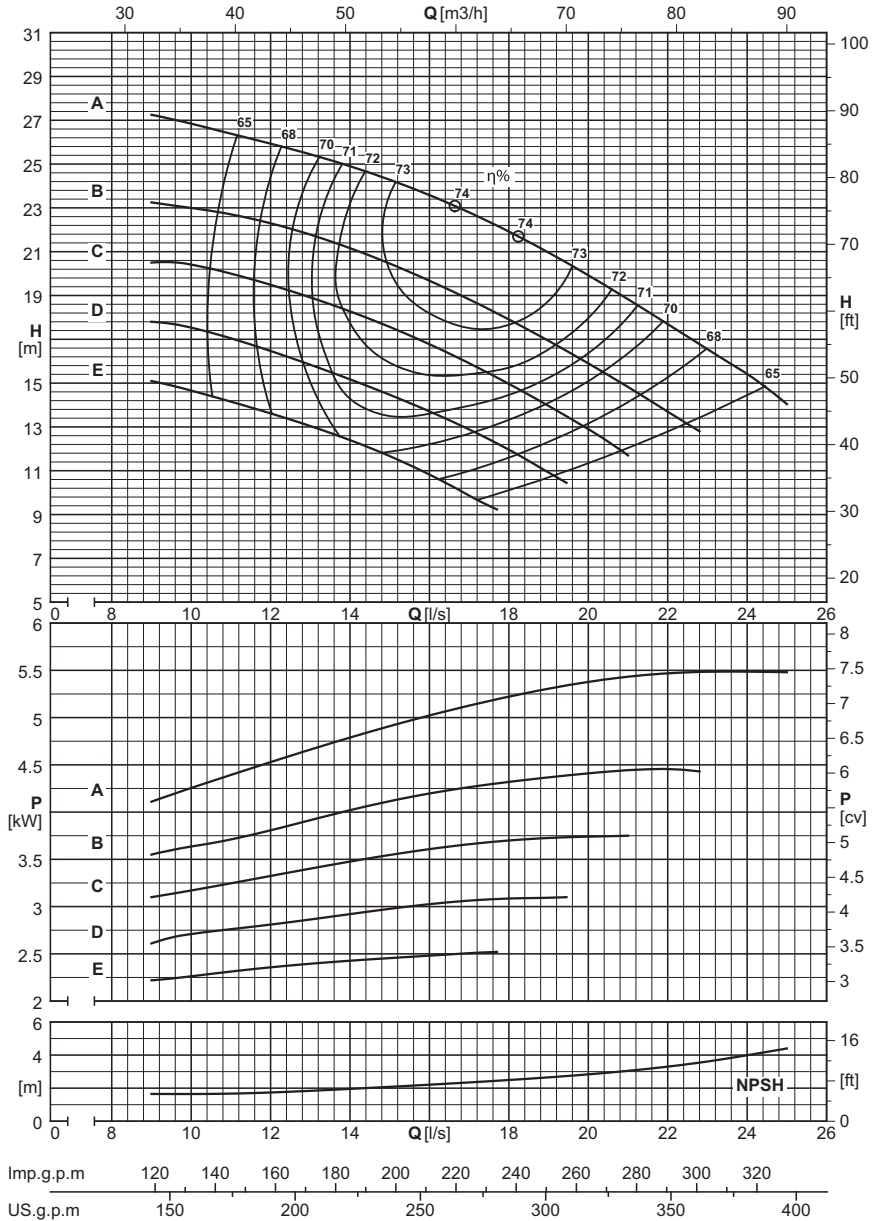

		Capacity - Debit - Portata																			
Dna x DNm	Impeller type Roue type Girante tipo	[l/s]	0	10	11	12	13	14	15	16	17	18	19	20	21	22	23	24	25		
		[m³/h]	0	36	39,6	43,2	46,8	50,4	54	57,6	61,2	64,8	68,4	72	75,6	79,2	82,8	86,4	90		
		[l/min]	0	600	660	720	780	840	900	960	1020	1080	1140	1200	1260	1320	1380	1440	1500		
		PM(S/H)80/1																			
100x80	E	[m]	16,5	14,5	14,5	13,5	13	12,5	11,5	11	10	9,1									
100x80	E	[kW]		2,3	2,3	2,3	2,4	2,4	2,5	2,5	2,5	2,6									
100x80	D	[m]	18,5	17,5	17	16,5	16	15	14,5	13,5	13	12	11	10							
100x80	D	[kW]		2,7	2,7	2,9	2,9	2,9	3	3	3	3,1	3,1	3,2							
100x80	C	[m]	21,5	21	20	19,5	18,5	18,5	17,5	17	16	15,5	14	13,5	11,5						
100x80	C	[kW]		3,1	3,3	3,3	3,4	3,5	3,6	3,6	3,6	3,7	3,7	3,8	3,7						
100x80	B	[m]	24,5		23,5	22	22	21	20,5	20	19	18	17	16	14,5	13,5	12,5				
100x80	B	[kW]			3,7	3,8	3,8	4	4,2	4,1	4,3	4,4	4,3	4,4	4,4	4,4	4,5				
100x80	A	[m]	29,5		26	26,5	25,5	25,5	24	23,5	22,5	22	21	20	19	18	16,5	15,5	14,5		
100x80	A	[kW]			4,5	4,4	4,6	4,8	4,9	5,1	5,2	5,2	5,3	5,4	5,5	5,6	5,4	5,4	5,5		
		NPSH																			
		[m]		1,7	1,7	1,7	1,8	2	2,1	2,2	2,3	2,5	2,7	2,8	3	3,3	3,6	4	4,4		

Overall dimensions and weights
 Dimensions d'encombrement et poids
 Dimensioni di ingombro e pesi

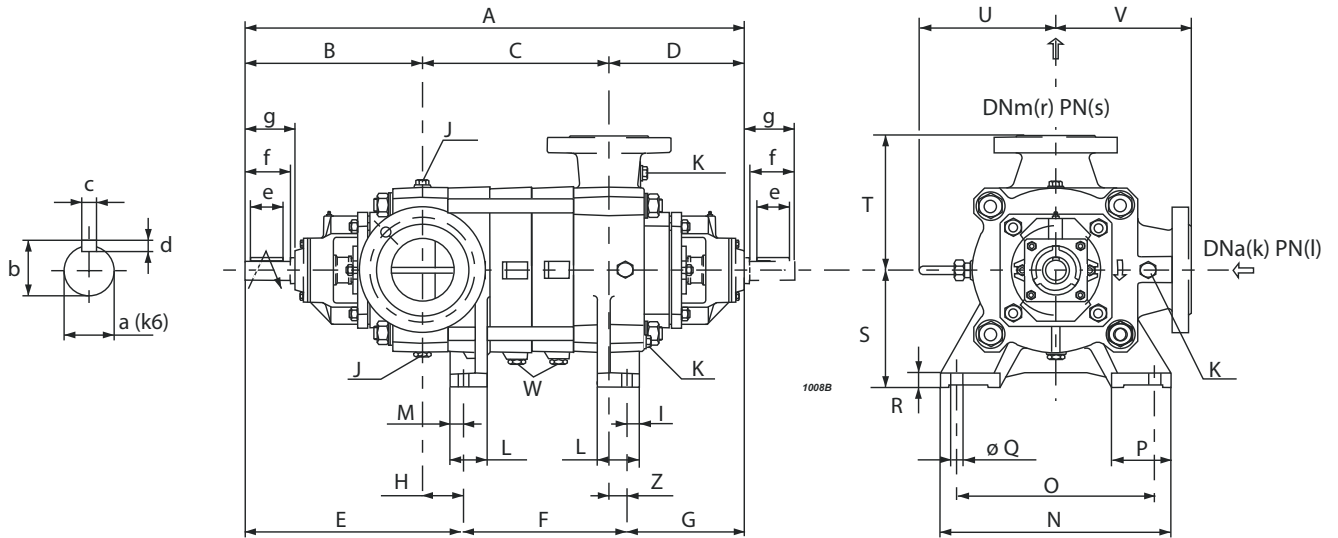

Series Série Serie	Type Type Tipo	A	B	C	D	E	F	G	H	S	T	U	V	Z	Weight Poids Peso [kg]
		[mm]													
PM(S)	80/2	805	360	171	274	422	138	245	61,5	200	245	258	245	29	179
PM(S)	80/3	875	360	241	274	422	208	245	61,5	200	245	258	245	29	200
PM(S)	80/4	945	360	311	274	422	278	245	61,5	200	245	258	245	29	221
PM(S/H)	80/5	1015	360	381	274	422	348	245	61,5	200	245	258	245	29	242
PM(S/H)	80/6	1085	360	451	274	422	418	245	61,5	200	245	258	245	29	263
PM(S/H)	80/7	1155	360	521	274	422	488	245	61,5	200	245	258	245	29	284
PM(S/H)	80/8	1225	360	591	274	422	558	245	61,5	200	245	258	245	29	305
PM(S/H)	80/9	1295	360	661	274	422	628	245	61,5	200	245	258	245	29	326
PM(S/H)	80/10	1365	360	731	274	422	698	245	61,5	200	245	258	245	29	347
PM(S/H)	80/11	1435	360	801	274	422	768	245	61,5	200	245	258	245	29	368
PM(S/H)	80/12	1505	360	871	274	422	838	245	61,5	200	245	258	245	29	389
PM(S/H)	80/13	1575	360	941	274	422	908	245	61,5	200	245	258	245	29	410
PM(S/H)	80/14	1645	360	1011	274	422	978	245	61,5	200	245	258	245	29	431
PM(S/H)	80/15	1715	360	1081	274	422	1048	245	61,5	200	245	258	245	29	452
PM(S/H)	80/16	1785	360	1151	274	422	1118	245	61,5	200	245	258	245	29	473

Foot dimensions Dimensions des pieds Dimensioni dei piedi								
I	L	M	N	O	P	Q	R	
[mm]								
26	70	25	420	370	102	24	25	

Shaft projection Saille d'arbre Sporgenza d'albero						
a	b	c	d	e	f	g
[mm]						
35	38	10	8	70	90	104

Flanges Brides Flange				
Type Type Tipo	(k) DNa	(l) PN	(r) DNm	(s) PN
	[mm]	[bar]	[mm]	[bar]
PM	100	25	80	40
PMS	100	25	80	63
PMH	100	40	80	100

Plugs Bouchons Tappi		
J	K	W
G1/2	G1/2	G1/4

Selection - dimensions and weights for base mounted electric pumps
Sélection - dimensions et poids des électropompes sur socle
 Selezione - dimensioni e pesi elettropompe su base

COUPLINGS WITH STANDARDIZED ENCLOSED ELECTRIC MOTORS
ACCROUPEMENTS AVEC MOTEURS ÉLECTRIQUES FERMÉS NORMALISÉS
 ACCOPIAMENTI CON MOTORI ELETTRICI CHIUSI NORMALIZZATI

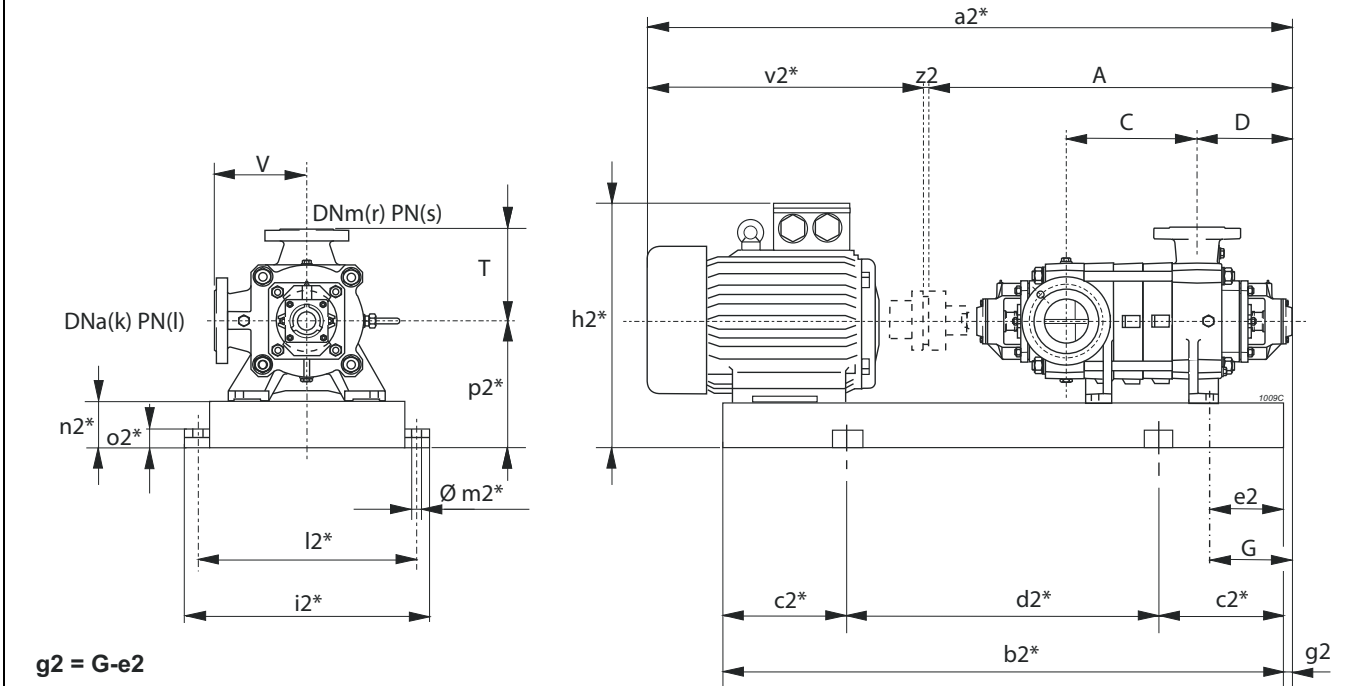

* Valori indicativi in funzione della marca di motore utilizzato
Indicative values according to the type of motor installed

Pump Pompe Pompa		Motor Moteur Motore		BGAM	A	C	D	G	T	V	a2*	b2*	c2*	d2*	e2	h2*	i2*	k	l	l2*	m2*	n2*	o2*	p2*	r	s	v2*	z2	Weight Poids Peso
Serie Série Serie	Type Type Tipo	[kW]	Size Taille Grand.	Type Type Tipo	[mm]																								[kg]
PM(S)	80/2	18,5	160L	615/DN	804,5	170,5	274	245	245	245	1435,5	1151	200	751	50	551	550	100	(1)	500	20	100	42	300	80	(2)	627	4	377
PM(S)	/2	22	180M	616/EN	804,5	170,5	274	245	245	245	1473,5	1161	200	761	50	570	550	100	(1)	500	20	100	42	300	80	(2)	665	4	418
PM(S)	/2	30	200L	617/FN	804,5	170,5	274	245	245	245	1546,5	1234	200	834	50	600	550	100	(1)	500	20	100	42	300	80	(2)	738	4	472
PM(S)	/2	37	200L	617/FN	804,5	170,5	274	245	245	245	1546,5	1234	200	834	50	600	550	100	(1)	500	20	100	42	300	80	(2)	738	4	500
PM(S)	80/3	30	200L	618/FN	874,5	240,5	274	245	245	245	1616,5	1304	200	904	50	600	550	100	(1)	500	20	100	42	300	80	(2)	738	4	495
PM(S)	/3	37	200L	618/FN	874,5	240,5	274	245	245	245	1616,5	1304	200	904	50	600	550	100	(1)	500	20	100	42	300	80	(2)	738	4	523
PM(S)	/3	45	225M	619/FN	874,5	240,5	274	245	245	245	1653,5	1350	250	850	70	675	585	100	(1)	535	20	120	42	345	80	(2)	775	4	599
PM(S)	/3	55	250M	620/GN	874,5	240,5	274	245	245	245	1748,5	1412	250	912	60	745	635	100	(1)	585	20	120	42	370	80	(2)	870	4	689
PM(S)	80/4	37	200L	621/FN	944,5	310,5	274	245	245	245	1686,5	1374	250	874	50	600	550	100	(1)	500	20	100	42	300	80	(2)	738	4	545
PM(S)	/4	45	225M	622/FN	944,5	310,5	274	245	245	245	1723,5	1420	250	920	70	675	585	100	(1)	535	20	120	42	345	80	(2)	775	4	622
PM(S)	/4	55	250M	623/GN	944,5	310,5	274	245	245	245	1818,5	1482	250	982	60	745	635	100	(1)	585	20	120	42	370	80	(2)	870	4	712
PM(S)	/4	75 ○	280S	624/HN	944,5	310,5	274	245	245	245	1948,5	1559	250	1059	90	815	695	100	(1)	645	20	140	42	420	80	(2)	1000	4	934
PM(S)	/4	90 ○	280M	652/HN	944,5	310,5	274	245	245	245	1999,5	1610	250	1110	90	815	695	100	(1)	645	20	140	42	420	80	(2)	1051	4	1063
PM(S/H)	80/5	45	225M	625/FN	1014,5	380,5	274	245	245	245	1739,5	1490	250	990	70	675	585	100	(1)	535	20	120	42	345	80	(2)	775	4	645
PM(S/H)	/5	55	250M	626/GN	1014,5	380,5	274	245	245	245	1888,5	1552	250	1052	60	745	635	100	(1)	585	20	120	42	370	80	(2)	870	4	735
PM(S/H)	/5	75 ○	280S	627/HN	1014,5	380,5	274	245	245	245	2018,5	1629	250	1129	90	815	695	100	(1)	645	20	140	42	420	80	(2)	1000	4	957
PM(S/H)	/5	90 ○	280M	628/HN	1014,5	380,5	274	245	245	245	2069,5	1680	300	1080	90	815	695	100	(1)	645	20	140	42	420	80	(2)	1051	4	1086
PM(S/H)	80/6	55	250M	629/GN	1084,5	450,5	274	245	245	245	1958,5	1622	250	1122	60	745	635	100	(1)	585	20	120	42	370	80	(2)	870	4	758
PM(S/H)	/6	75 ○	280S	630/HN	1084,5	450,5	274	245	245	245	2088,5	1699	300	1099	90	815	695	100	(1)	645	20	140	42	420	80	(2)	1000	4	980
PM(S/H)	/6	90 ○	280M	631/HN	1084,5	450,5	274	245	245	245	2139,5	1750	300	1150	90	815	695	100	(1)	645	20	140	42	420	80	(2)	1051	4	1109
PM(S/H)	/6	110 ○	315S	632/IN	1084,5	450,5	274	245	245	245	2269,5	1796	300	1196	90	1030	780	100	(1)	730	22	160	50	475	80	(2)	1181	4	1402
PM(S/H)	80/7	55	250M	633/GN	1154,5	520,5	274	245	245	245	2028,5	1692	300	1092	60	745	635	100	(1)	585	20	120	42	370	80	(2)	870	4	781
PM(S/H)	/7	75 ○	280S	634/HN	1154,5	520,5	274	245	245	245	2158,5	1769	300	1169	90	815	695	100	(1)	645	20	140	42	420	80	(2)	1000	4	1004
PM(S/H)	/7	90 ○	280M	635/IN	1154,5	520,5	274	245	245	245	2209,5	1820	300	1220	90	815	695	100	(1)	645	20	140	42	420	80	(2)	1051	4	1132
PM(S/H)	/7	110 ○	315S	636/IN	1154,5	520,5	274	245	245	245	2339,5	1866	300	1266	90	1030	780	100	(1)	730	22	160	50	475	80	(2)	1181	4	1426
PM(S/H)	/7	132 ○	315M	637/IN	1154,5	520,5	274	245	245	245	2449,5	1925	300	1325	90	1030	780	100	(1)	730	22	160	50	475	80	(2)	1291	4	1500
PM(S/H)	80/8	75 ○	280S	638/HN	1224,5	590,5	274	245	245	245	2228,5	1839	300	1239	90	815	695	100	(1)	645	20	140	42	420	80	(2)	1000	4	1027
PM(S/H)	/8	90 ○	280M	639/HN	1224,5	590,5	274	245	245	245	2279,5	1890	300	1290	90	815	695	100	(1)	645	20	140	42	420	80	(2)	1051	4	1156
PM(S/H)	/8	110 ○	315S	640/IN	1224,5	590,5	274	245	245	245	2409,5	1936	300	1336	90	1030	780	100	(1)	730	22	160	50	475	80	(2)	1181	4	1449

BGAM = Base and coupling

* = Indicatives values according to the type of motor installed.

○ Motor in IE4 efficiency class according to EU REGULATION 2019/1781. Available in other efficiency classes for non-EU markets.

- (1) PM=25 bar PMS=25 bar PMH=40 bar
- (2) PM=40 bar PMS=63 bar PMH=100 bar

BGAM = Socle et accouplement

* = Valeurs indicatives en fonction de la marque du moteur utilisé.

○ Moteur en classe de rendement IE4 conformément au RÈGLEMENT UE2019/1781. Disponibilité en différentes classes de rendement pour les marchés hors UE.

- (1) PM=25 bar PMS=25 bar PMH=40 bar
- (2) PM=40 bar PMS=63 bar PMH=100 bar

BGAM = Base giunto e coprigiunto

* = Valori indicativi in funzione della marca di motore utilizzato.

○ Motore in classe di efficienza IE4 in conformità al REGOLAMENTO UE2019/1781. Disponibili in altre classi di efficienza per mercati extra UE.

- (1) PM=25 bar PMS=25 bar PMH=40 bar
- (2) PM=40 bar PMS=63 bar PMH=100 bar

Selection - dimensions and weights for base mounted electric pumps
 Sélection - dimensions et poids des électropompes sur socle
 Selezione - dimensioni e pesi elettropompe su base

COUPLINGS WITH STANDARDIZED ENCLOSED ELECTRIC MOTORS
 ACCOUPLEMENTS AVEC MOTEURS ÉLECTRIQUES FERMÉS NORMALISÉS
 ACCOPIAMENTI CON MOTORI ELETTRICI CHIUSI NORMALIZZATI

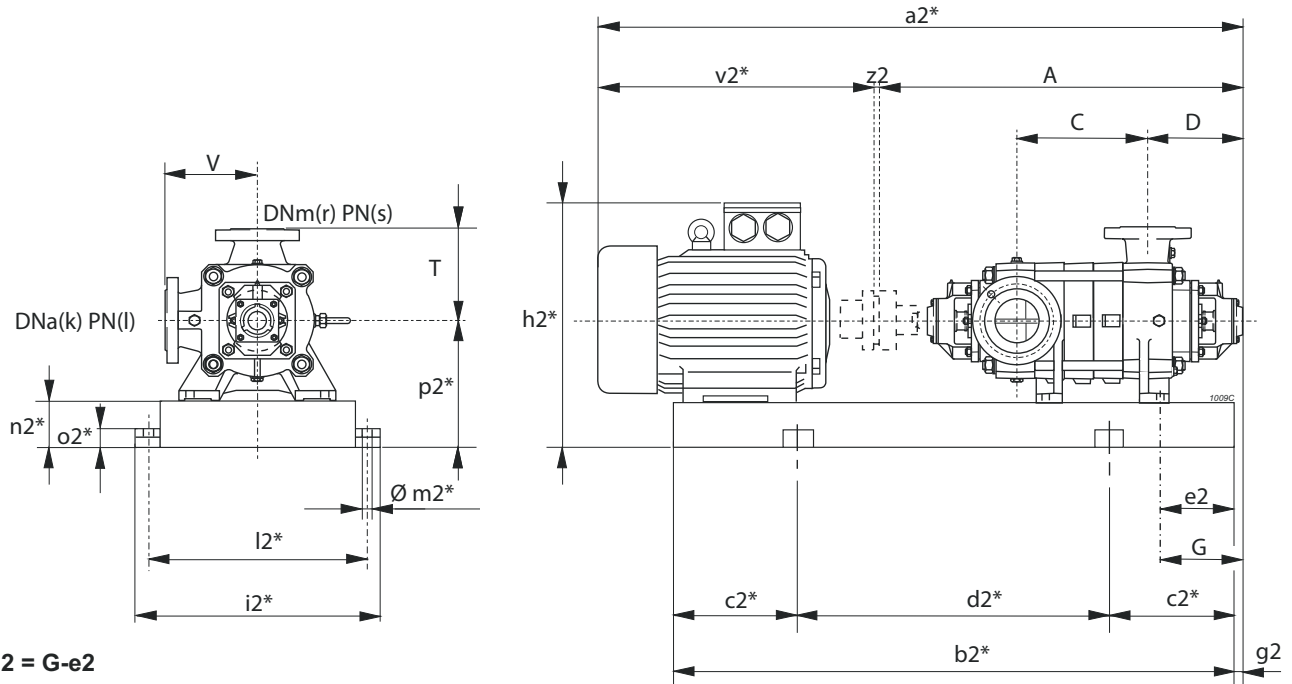

* Valori indicativi in funzione della marca di motore utilizzato
 Indicatives values according to the type of motor installed

Pump Pompe Pompa	Motor Moteur Motore	BGAM	A	C	D	G	T	V	a2*	b2*	c2*	d2*	e2	h2*	i2*	k	l	l2*	m2*	n2*	o2*	p2*	r	s	v2*	z2	Weight Poids Peso	
Series Série Serie	Type Type Tipo	Size Taille Grand.	Type Type Tipo	[mm]																						[kg]		
PM(S/H)	/8	132	315M	641/IN	1224,5	590,5	274	245	245	2519,5	2046	350	1346	90	1030	780	100	(1)	730	22	160	50	475	80	(2)	1291	4	1525
PM(S/H)	/8	160	315L	641/IN	1224,5	590,5	274	245	245	2519,5	2046	350	1346	90	1030	780	100	(1)	730	22	160	50	475	80	(2)	1291	4	1603
PM(S/H)	/8	200	315L	642/IE4/LQ	1224,5	590,5	274	245	245	2609,5	2136	350	1436	198	1030	780	100	(1)	730	22	160	50	475	80	(2)	1381	4	1719
PM(S/H)	80/9	75	280S	643/HN	1294,5	660,5	274	245	245	2298,5	1909	300	1309	90	815	695	100	(1)	645	20	140	42	420	80	(2)	1000	4	1050
PM(S/H)	/9	90	280M	644/HN	1294,5	660,5	274	245	245	2349,5	1960	350	1260	90	815	695	100	(1)	645	20	140	42	420	80	(2)	1051	4	1179
PM(S/H)	/9	110	315S	645/IN	1294,5	660,5	274	245	245	2479,5	2006	350	1306	90	1030	780	100	(1)	730	22	160	50	475	80	(2)	1181	4	1473
PM(S/H)	/9	132	315M	646/IN	1294,5	660,5	274	245	245	2589,5	2065	350	1365	90	1030	780	100	(1)	730	22	160	50	475	80	(2)	1291	4	1547
PM(S/H)	/9	160	315L	647/LQ	1294,5	660,5	274	245	245	2589,5	2116	350	1416	90	1030	780	100	(1)	730	22	160	50	475	80	(2)	1291	4	1632
PM(S/H)	/9	200	315L	647/IE4/LQ	1294,5	660,5	274	245	245	2679,5	2206	350	1506	198	1030	780	100	(1)	730	22	160	50	475	80	(2)	1381	4	1742
PM(S/H)	80/10	90	280M	648/HN	1364,5	730,5	274	245	245	2419,5	2030	350	1330	90	815	695	100	(1)	645	20	140	42	420	80	(2)	1051	4	1202
PM(S/H)	/10	110	315S	649/IN	1364,5	730,5	274	245	245	2549,5	2076	350	1376	90	1030	780	100	(1)	730	22	160	50	475	80	(2)	1181	4	1497
PM(S/H)	/10	132	315M	650/IN	1364,5	730,5	274	245	245	2659,5	2186	350	1486	90	1030	780	100	(1)	730	22	160	50	475	80	(2)	1291	4	1573
PM(S/H)	/10	160	315L	650/IN	1364,5	730,5	274	245	245	2659,5	2186	350	1486	90	1030	780	100	(1)	730	22	160	50	475	80	(2)	1291	4	1651
PM(S/H)	/10	200	315L	651/IE4/LQ	1364,5	730,5	274	245	245	2749,5	2276	400	1476	198	1030	780	100	(1)	730	22	160	50	475	80	(2)	1381	4	1765
PM(S/H)	80/11	90	280M	6648/HN	1434,5	800,5	274	245	245	2489,5	2100	350	1400	90	815	695	100	(1)	645	20	140	42	420	80	(2)	1051	4	1225
PM(S/H)	/11	110	315S	1200/IS	1434,5	800,5	274	245	245	2619,5	2146	350	1446	90	1030	780	100	(1)	730	22	160	50	475	80	(2)	1181	4	1520
PM(S/H)	/11	132	315M	1201/IN	1434,5	800,5	274	245	245	2729,5	2256	400	1456	90	1030	780	100	(1)	730	22	160	50	475	80	(2)	1291	4	1596
PM(S/H)	/11	160	315L	1201/IN	1434,5	800,5	274	245	245	2729,5	2256	400	1456	90	1030	780	100	(1)	730	22	160	50	475	80	(2)	1291	4	1674
PM(S/H)	/11	200	315L	1202/IE4/LQ	1434,5	800,5	274	245	245	2819,5	2346	400	1546	198	1030	780	100	(1)	730	22	160	50	475	80	(2)	1381	4	1789
PM(S/H)	80/12	110	315S	1203/IN	1504,5	870,5	274	245	245	2689,5	2216	350	1516	90	1030	780	100	(1)	730	22	160	50	475	80	(2)	1181	4	1544
PM(S/H)	/12	132	315M	1204/IN	1504,5	870,5	274	245	245	2799,5	2326	400	1526	90	1030	780	100	(1)	730	22	160	50	475	80	(2)	1291	4	1620
PM(S/H)	/12	160	315L	1204/IN	1504,5	870,5	274	245	245	2799,5	2326	400	1526	90	1030	780	100	(1)	730	22	160	50	475	80	(2)	1291	4	1698
PM(S/H)	/12	200	315L	1205/IE4/LQ	1504,5	870,5	274	245	245	2889,5	2416	400	1616	198	1030	780	100	(1)	730	22	160	50	475	80	(2)	1381	4	1812
PM(S/H)	/12	250	355M	1206/LQ	1504,5	870,5	274	245	245	3034,5	2400	400	1600	110	1136	880	100	(1)	830	22	180	50	535	80	(2)	1526	4	2256
PM(H)	80/13	110	315S	12203/IN	1574,5	940,5	274	245	245	2759,5	2286	400	1486	90	1030	780	100	(1)	730	22	160	50	475	80	(2)	1181	4	1567
PM(H)	/13	132	315M	1207/IN	1574,5	940,5	274	245	245	2869,5	2396	400	1596	90	1030	780	100	(1)	730	22	160	50	475	80	(2)	1291	4	1644
PM(H)	/13	160	315L	1207/IN	1574,5	940,5	274	245	245	2869,5	2396	400	1596	90	1030	780	100	(1)	730	22	160	50	475	80	(2)	1291	4	1722
PM(H)	/13	200	315L	1208/IE4/LQ	1574,5	940,5	274	245	245	2959,5	2486	400	1686	198	1030	780	100	(1)	730	22	160	50	475	80	(2)	1381	4	1835
PM(H)	/13	250	355M	1209/LQ	1574,5	940,5	274	245	245	3104,5	2470	400	1670	110	1136	880	100	(1)	830	22	180	50	535	80	(2)	1526	4	2280

BGAM = Base and coupling

* = Indicatives values according to the type of motor installed.

○ Motor in IE4 efficiency class according to EU REGULATION 2019/1781. Available in other efficiency classes for non-EU markets.

(1) PM=25 bar PMS=25 bar PMH=40 bar

(2) PM=40 bar PMS=63 bar PMH=100 bar

BGAM = Socle et accouplement

* = Valeurs indicatives en fonction de la marque du moteur utilisé.

○ Moteur en classe de rendement IE4 conformément au RÈGLEMENT UE2019/1781. Disponibilité en différentes classes de rendement pour les marchés hors UE.

(1) PM=25 bar PMS=25 bar PMH=40 bar

(2) PM=40 bar PMS=63 bar PMH=100 bar

BGAM = Base giunto e coprigiunto

* = Valori indicativi in funzione della marca di motore utilizzato.

○ Motore in classe di efficienza IE4 in conformità al REGOLAMENTO UE2019/1781. Disponibili in altre classi di efficienza per mercati extra UE.

(1) PM=25 bar PMS=25 bar PMH=40 bar

(2) PM=40 bar PMS=63 bar PMH=100 bar

Selection - dimensions and weights for base mounted electric pumps
Sélection - dimensions et poids des électropompes sur socle
 Selezione - dimensioni e pesi elettropompe su base

COUPLINGS WITH STANDARDIZED ENCLOSED ELECTRIC MOTORS
 ACCOUPLEMENTS AVEC MOTEURS ÉLECTRIQUES FERMÉS NORMALISÉS
 ACCOPIAMENTI CON MOTORI ELETTRICI CHIUSI NORMALIZZATI

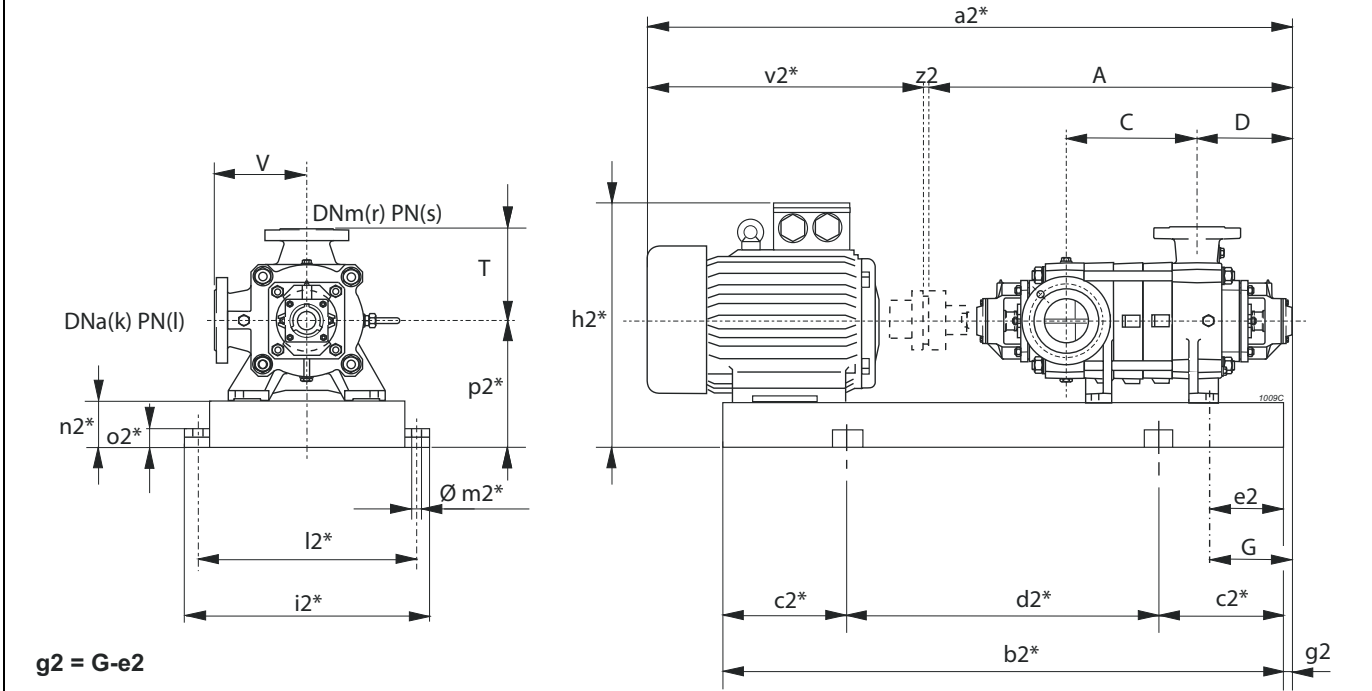

* Valori indicativi in funzione della marca di motore utilizzato
Indicatives values according to the type of motor installed

Pump Pompe Pompa		Motor Moteur Motore		BGAM	A	C	D	G	T	V	a2*	b2*	c2*	d2*	e2	h2*	i2*	k	l	l2*	m2*	n2*	o2*	p2*	r	s	v2*	z2	Weight Poids Peso
Series Série Serie	Type Type Tipo	[kW]	Size Taille Grand.	Type Type Tipo	[mm]																								[kg]
PM(H)	80/14	132	315M	1210/IN	1644,5	1010,5	274	245	245	245	2939,5	2466	400	1666	90	1030	780	100	(1)	730	22	160	50	475	80	(2)	1291	4	1667
PM(H)	/14	160	315L	1210/IN	1644,5	1010,5	274	245	245	245	2939,5	2466	400	1666	90	1030	780	100	(1)	730	22	160	50	475	80	(2)	1291	4	1745
PM(H)	/14	200	315L	1211/IE4/LQ	1644,5	1010,5	274	245	245	245	3029,5	2556	450	1656	198	1030	780	100	(1)	730	22	160	50	475	80	(2)	1381	4	1858
PM(H)	/14	250	355M	1212/LQ	1644,5	1010,5	274	245	245	245	3174,5	2540	400	1740	110	1136	880	100	(1)	830	22	180	50	535	80	(2)	1526	4	2304
PM(H)	80/15	132	315M	1213/IN	1714,5	1080,5	274	245	245	245	3009,5	2536	400	1736	90	1030	780	100	(1)	730	22	160	50	475	80	(2)	1291	4	1691
PM(H)	/15	160	315L	1213/IN	1714,5	1080,5	274	245	245	245	3009,5	2536	400	1736	90	1030	780	100	(1)	730	22	160	50	475	80	(2)	1291	4	1769
PM(H)	/15	200	315L	1214/IE4/LQ	1714,5	1080,5	274	245	245	245	3099,5	2626	450	2726	198	1030	780	100	(1)	730	22	160	50	475	80	(2)	1381	4	1881
PM(H)	/15	250	355M	1215/LQ	1714,5	1080,5	274	245	245	245	3244,5	2680	450	1780	110	1136	880	100	(1)	830	22	180	50	535	80	(2)	1526	4	2331
PM(H)	/15	280	355L	1215/LQ	1714,5	1080,5	274	245	245	245	3244,5	2680	450	1780	110	1136	880	100	(1)	830	22	180	50	535	80	(2)	1526	4	2456
PM(H)	80/16	132	315M	1216/IN	1784,5	1150,5	274	245	245	245	3079,5	2606	450	1706	90	1030	780	100	(1)	730	22	160	50	475	80	(2)	1291	4	1714
PM(H)	/16	160	315L	1216/IN	1784,5	1150,5	274	245	245	245	3079,5	2606	450	1706	90	1030	780	100	(1)	730	22	160	50	475	80	(2)	1291	4	1792
PM(H)	/16	200	315L	1217/IE4/LQ	1784,5	1150,5	274	245	245	245	3169,5	2696	450	2796	198	1030	780	100	(1)	730	22	160	50	475	80	(2)	1381	4	1904
PM(H)	/16	250	355M	1218/LQ	1784,5	1150,5	274	245	245	245	3314,5	2750	450	1850	110	1136	880	100	(1)	830	22	180	50	535	80	(2)	1526	4	2357
PM(H)	/16	315	355L	1218/MQ	1784,5	1150,5	274	245	245	245	3314,5	2750	450	1850	110	1136	880	100	(1)	830	22	180	50	535	80	(2)	1526	4	2486

BGAM = Base and coupling

* = Indicatives values according to the type of motor installed.

○ Motor in IE4 efficiency class according to EU REGULATION 2019/1781. Available in other efficiency classes for non-EU markets.

- (1) PM=25 bar PMS=25 bar PMH=40 bar
- (2) PM=40 bar PMS=63 bar PMH=100 bar

BGAM = Socle et accouplement

* = Valeurs indicatives en fonction de la marque du moteur utilisé.

○ Moteur en classe de rendement IE4 conformément au RÈGLEMENT UE2019/1781. Disponibilité en différentes classes de rendement pour les marchés hors UE.

- (1) PM=25 bar PMS=25 bar PMH=40 bar
- (2) PM=40 bar PMS=63 bar PMH=100 bar

BGAM = Base giunto e coprigiunto

* = Valori indicativi in funzione della marca di motore utilizzato.

○ Motore in classe di efficienza IE4 in conformità al REGOLAMENTO UE2019/1781. Disponibili in altre classi di efficienza per mercati extra UE.

- (1) PM=25 bar PMS=25 bar PMH=40 bar
- (2) PM=40 bar PMS=63 bar PMH=100 bar

Selection - dimensions and weights for base mounted electric pumps
 Sélection - dimensions et poids des électropompes sur socle
 Selezione - dimensioni e pesi elettropompe su base

COUPLINGS WITH STANDARDIZED ENCLOSED ELECTRIC MOTORS
 ACCOUPLEMENTS AVEC MOTEURS ÉLECTRIQUES FERMÉS NORMALISÉS
 ACCOPIAMENTI CON MOTORI ELETTRICI CHIUSI NORMALIZZATI

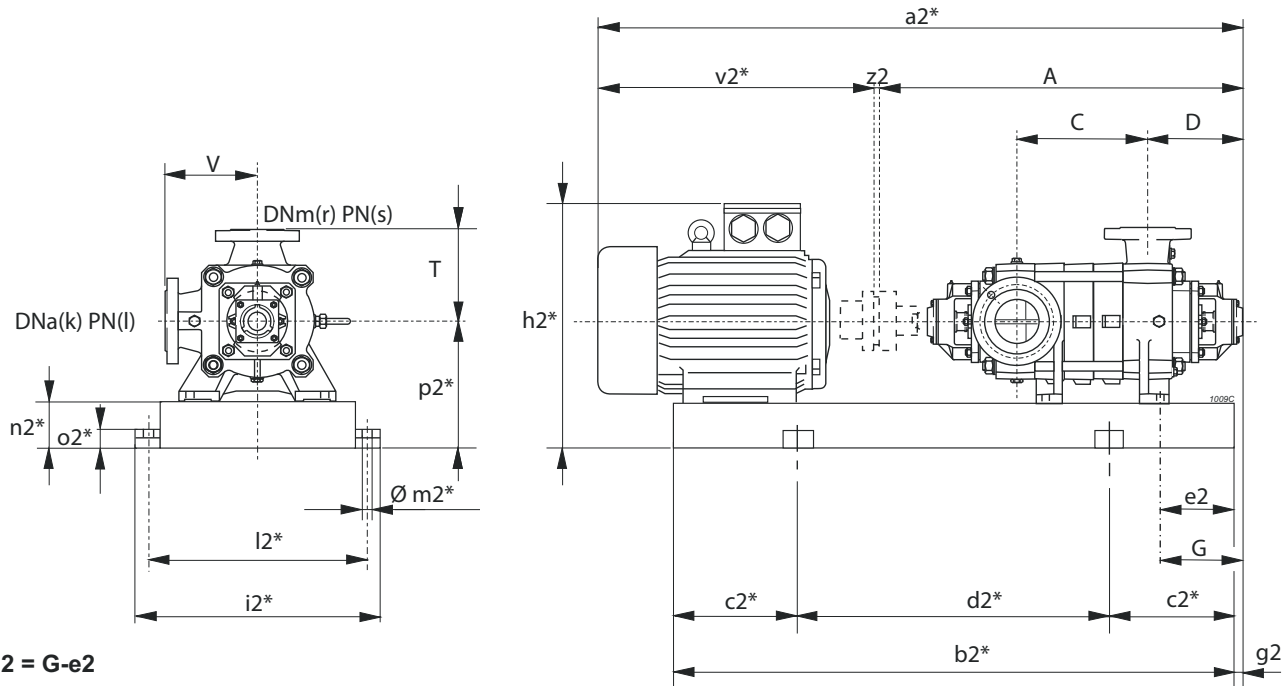

* Valori indicativi in funzione della marca di motore utilizzato
 Indicatives values according to the type of motor installed

Pump Pompe Pompa		Motor Moteur Motore		BGAM	A	C	D	G	T	V	a2*	b2*	c2*	d2*	e2	h2*	i2*	k	l	l2*	m2*	n2*	o2*	p2*	r	s	v2*	z2	Weight Poids Peso				
Series Série Serie	Type Type Tipo	[kW]	Size Taille Grand.	Type Type Tipo	[mm]																												[kg]
PM(S)	80/2	2,2	100L	655/CN	804,5	170,5	274	245	245	245	1213,5	915	150	615	50	450	550	100	(1)	500	20	100	42	300	80	(2)	405	4	257				
PM(S)	/2	3	100L	655/CN	804,5	170,5	274	245	245	245	1213,5	915	150	615	50	450	550	100	(1)	500	20	100	42	300	80	(2)	405	4	261				
PM(S)	/2	4	112M	656/CN	804,5	170,5	274	245	245	245	1248,5	922	150	622	50	472	550	100	(1)	500	20	100	42	300	80	(2)	440	4	262				
PM(S)	/2	5,5	132S	657/DN	804,5	170,5	274	245	245	245	1263,5	963	150	663	50	492	550	100	(1)	500	20	100	42	300	80	(2)	455	4	272				
PM(S)	80/3	3	100L	6655/CN	874,5	240,5	274	245	245	245	1283,5	985	150	685	50	450	550	100	(1)	500	20	100	42	300	80	(2)	405	4	283				
PM(S)	/3	4	112M	658/CN	874,5	240,5	274	245	245	245	1318,5	992	150	692	50	472	550	100	(1)	500	20	100	42	300	80	(2)	440	4	285				
PM(S)	/3	5,5	132S	659/DN	874,5	240,5	274	245	245	245	1333,5	1033	150	733	50	492	550	100	(1)	500	20	100	42	300	80	(2)	455	4	294				
PM(S)	/3	7,5	132M	660/DN	874,5	240,5	274	245	245	245	1368,5	1071	200	671	50	492	550	100	(1)	500	20	100	42	300	80	(2)	490	4	304				
PM(S)	80/4	4	112M	6658/CN	944,5	310,5	274	245	245	245	1388,5	1062	200	662	50	472	550	100	(1)	500	20	100	42	300	80	(2)	440	4	307				
PM(S)	/4	5,5	132S	661/DN	944,5	310,5	274	245	245	245	1403,5	1103	200	703	50	492	550	100	(1)	500	20	100	42	300	80	(2)	455	4	317				
PM(S)	/4	7,5	132M	662/DN	944,5	310,5	274	245	245	245	1438,5	1141	200	741	50	492	550	100	(1)	500	20	100	42	300	80	(2)	490	4	326				
PM(S)	/4	11	160M	663/EN	944,5	310,5	274	245	245	245	1575,5	1247	200	847	50	551	550	100	(1)	500	20	100	42	300	80	(2)	627	4	412				
PM(S/H)	80/5	5,5	132S	664/DN	1014,5	380,5	274	245	245	245	1473,5	1173	200	773	50	492	550	100	(1)	500	20	100	42	300	80	(2)	455	4	339				
PM(S/H)	/5	7,5	132M	665/DN	1014,5	380,5	274	245	245	245	1508,5	1211	200	811	50	492	550	100	(1)	500	20	100	42	300	80	(2)	490	4	349				
PM(S/H)	/5	11	160M	666/EN	1014,5	380,5	274	245	245	245	1645,5	1317	200	917	50	551	550	100	(1)	500	20	100	42	300	80	(2)	627	4	435				
PM(S/H)	/5	15	160L	667/EN	1014,5	380,5	274	245	245	245	1645,5	1361	250	861	50	551	550	100	(1)	500	20	100	42	300	80	(2)	627	4	448				
PM(S/H)	80/6	7,5	132M	668/DN	1084,5	450,5	274	245	245	245	1578,5	1281	200	881	50	492	550	100	(1)	500	20	100	42	300	80	(2)	490	4	371				
PM(S/H)	/6	11	160M	669/EN	1084,5	450,5	274	245	245	245	1715,5	1387	250	887	50	551	550	100	(1)	500	20	100	42	300	80	(2)	627	4	457				
PM(S/H)	/6	15	160L	670/EN	1084,5	450,5	274	245	245	245	1715,5	1431	250	931	50	551	550	100	(1)	500	20	100	42	300	80	(2)	627	4	470				
PM(S/H)	80/7	7,5	132M	671/DN	1154,5	520,5	274	245	245	245	1648,5	1351	250	851	50	492	550	100	(1)	500	20	100	42	300	80	(2)	490	4	394				
PM(S/H)	/7	11	160M	672/EN	1154,5	520,5	274	245	245	245	1785,5	1457	250	957	50	551	550	100	(1)	500	20	100	42	300	80	(2)	627	4	480				
PM(S/H)	/7	15	160L	673/EN	1154,5	520,5	274	245	245	245	1785,5	1501	250	1001	50	551	550	100	(1)	500	20	100	42	300	80	(2)	627	4	493				
PM(S/H)	/7	18,5	180M	674/FN	1154,5	520,5	274	245	245	245	1823,5	1511	250	1011	50	570	550	100	(1)	500	20	100	42	300	80	(2)	665	4	530				
PM(S/H)	80/8	11	160M	676/EN	1224,5	590,5	274	245	245	245	1855,5	1527	250	1027	50	551	550	100	(1)	500	20	100	42	300	80	(2)	627	4	502				
PM(S/H)	/8	15	160L	677/EN	1224,5	590,5	274	245	245	245	1855,5	1571	250	1071	50	551	550	100	(1)	500	20	100	42	300	80	(2)	627	4	515				
PM(S/H)	/8	18,5	180M	678/FN	1224,5	590,5	274	245	245	245	1893,5	1581	250	1081	50	570	550	100	(1)	500	20	100	42	300	80	(2)	665	4	552				
PM(S/H)	80/9	11	160M	679/EN	1294,5	660,5	274	245	245	245	1925,5	1597	250	1097	50	551	550	100	(1)	500	20	100	42	300	80	(2)	627	4	525				
PM(S/H)	/9	15	160L	680/EN	1294,5	660,5	274	245	245	245	1925,5	1641	250	1141	50	551	550	100	(1)	500	20	100	42	300	80	(2)	627	4	537				
PM(S/H)	/9	18,5	180M	681/FN	1294,5	660,5	274	245	245	245	1963,5	1651	300	1051	50	570	550	100	(1)	500	20	100	42	300	80	(2)	665	4	575				
PM(S/H)	/9	22	180L	682/FN	1294,5	660,5	274	245	245	245	2003,5	1689	300	1089	50	570	550	100	(1)	500	20	100	42	300	80	(2)	705	4	596				
PM(S/H)	80/10	11	160M	683/EN	1364,5	730,5	274	245	245	245	1995,5	1667	300	1067	50	551	550	100	(1)	500	20	100	42	300	80	(2)	627	4	547				
PM(S/H)	/10	15	160L	684/EN	1364,5	730,5	274	245	245	245	1995,5	1711	300	1111	50	551	550	100	(1)	500	20	100	42	300	80	(2)	627	4	560				

BGAM = Base and coupling

* = Indicatives values according to the type of motor installed.

(1) PM=25 bar PMS=25 bar PMH=40 bar

(2) PM=40 bar PMS=63 bar PMH=100 bar

BGAM = Socle et accouplement

* = Valeurs indicatives en fonction de la marque du moteur utilisé.

(1) PM=25 bar PMS=25 bar PMH=40 bar

(2) PM=40 bar PMS=63 bar PMH=100 bar

BGAM = Base giunto e coprigiunto

* = Valori indicativi in funzione della marca di motore utilizzato.

(1) PM=25 bar PMS=25 bar PMH=40 bar

(2) PM=40 bar PMS=63 bar PMH=100 bar

Selection - dimensions and weights for base mounted electric pumps
 Sélection - dimensions et poids des électropompes sur socle
 Selezione - dimensioni e pesi elettropompe su base

COUPLINGS WITH STANDARDIZED ENCLOSED ELECTRIC MOTORS
 ACCOUPLEMENTS AVEC MOTEURS ÉLECTRIQUES FERMÉS NORMALISÉS
 ACCOPPIAMENTI CON MOTORI ELETTRICI CHIUSI NORMALIZZATI

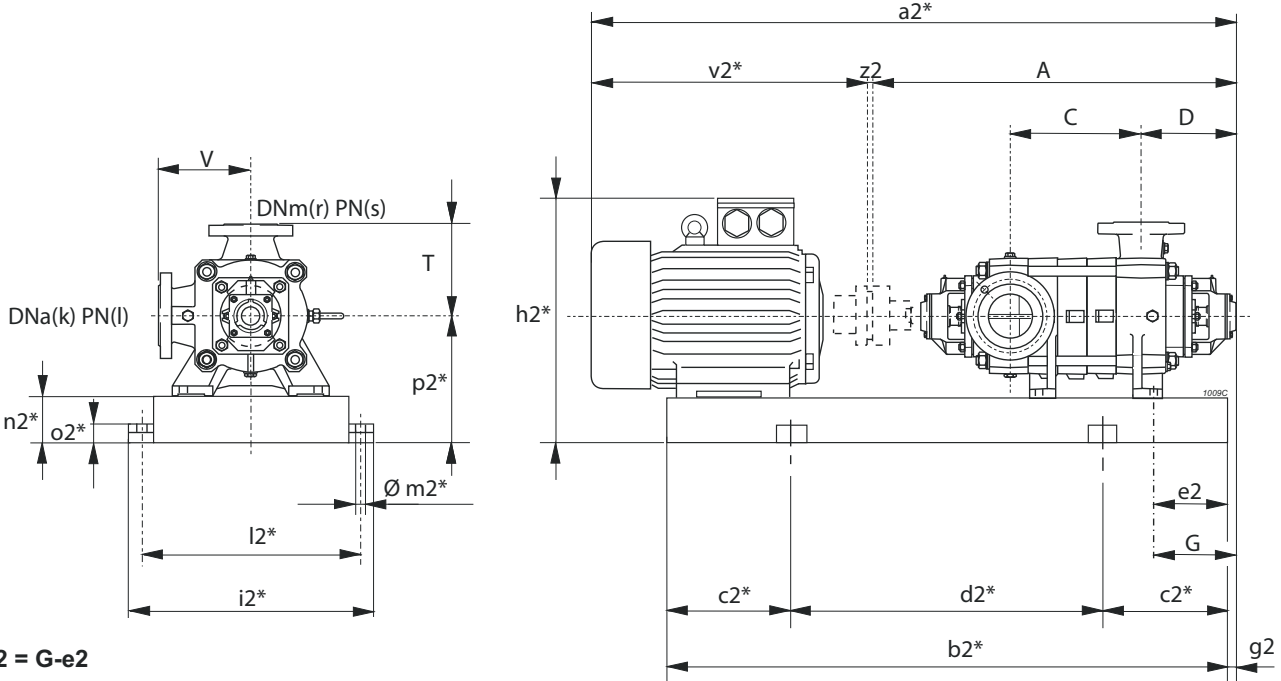

* Valori indicativi in funzione della marca di motore utilizzato
 Indicatives values according to the type of motor installed

Pump Pompe Pompa		Motor Moteur Motore		BGAM	A	C	D	G	T	V	a2*	b2*	c2*	d2*	e2	h2*	i2*	k	l	l2*	m2*	n2*	o2*	p2*	r	s	v2*	z2	Weight Poids Peso	
Series Série Serie	Type Type Tipo	[kW]	Size Taille Grand.	Type Type Tipo	[mm]																									[kg]
PM(S/H)	/10	18,5	180M	685/FN	1364,5	730,5	274	245	245	245	2033,5	1721	300	1121	50	570	550	100	(1)	500	20	100	42	300	80	(2)	665	4	597	
PM(S/H)	/10	22	180L	686/FN	1364,5	730,5	274	245	245	245	2073,5	1759	300	1159	50	570	550	100	(1)	500	20	100	42	300	80	(2)	705	4	618	
PM(S/H)	/10	30	200L	687/GN	1364,5	730,5	274	245	245	245	2126,5	1794	300	1194	50	600	550	100	(1)	500	20	100	42	300	80	(2)	758	4	680	
PM(S/H)	80/11	15	160L	688/EN	1434,5	800,5	274	245	245	245	2065,5	1781	300	1181	50	551	550	100	(1)	500	20	100	42	300	80	(2)	627	4	582	
PM(S/H)	/11	18,5	180M	689/FN	1434,5	800,5	274	245	245	245	2103,5	1791	300	1191	50	570	550	100	(1)	500	20	100	42	300	80	(2)	665	4	620	
PM(S/H)	/11	22	180L	690/FN	1434,5	800,5	274	245	245	245	2143,5	1829	300	1229	50	570	550	100	(1)	500	20	100	42	300	80	(2)	705	4	640	
PM(S/H)	/11	30	200L	691/GN	1434,5	800,5	274	245	245	245	2196,5	1864	300	1264	50	600	550	100	(1)	500	20	100	42	300	80	(2)	758	4	702	
PM(S/H)	80/12	15	160L	692/EN	1504,5	870,5	274	245	245	245	2135,5	1851	300	1251	50	551	550	100	(1)	500	20	100	42	300	80	(2)	627	4	605	
PM(S/H)	/12	18,5	180M	693/FN	1504,5	870,5	274	245	245	245	2173,5	1861	300	1261	50	570	550	100	(1)	500	20	100	42	300	80	(2)	665	4	656	
PM(S/H)	/12	22	180L	694/FN	1504,5	870,5	274	245	245	245	2213,5	1899	300	1299	50	570	550	100	(1)	500	20	100	42	300	80	(2)	705	4	663	
PM(S/H)	/12	30	200L	695/GN	1504,5	870,5	274	245	245	245	2266,5	1934	300	1334	50	600	550	100	(1)	500	20	100	42	300	80	(2)	758	4	725	
PM(S/H)	80/13	15	160L	1230/GN	1574,5	940,5	274	245	245	245	2205,5	1921	300	1321	50	551	550	100	(1)	500	20	100	42	300	80	(2)	627	4	630	
PM(S/H)	/13	18,5	180M	1231/FN	1574,5	940,5	274	245	245	245	2243,5	1931	300	1331	50	570	550	100	(1)	500	20	100	42	300	80	(2)	665	4	665	
PM(S/H)	/13	22	180L	1232/FN	1574,5	940,5	274	245	245	245	2283,5	1969	350	1269	50	570	550	100	(1)	500	20	100	42	300	80	(2)	705	4	685	
PM(S/H)	/13	30	200L	1233/FN	1574,5	940,5	274	245	245	245	2336,5	2004	350	1304	50	600	550	100	(1)	500	20	100	42	300	80	(2)	758	4	747	
PM(S/H)	80/14	15	160L	1234/EN	1644,5	1010,5	274	245	245	245	2275,5	1991	350	1291	50	551	550	100	(1)	500	20	100	42	300	80	(2)	627	4	650	
PM(S/H)	/14	18,5	180M	1235/FN	1644,5	1010,5	274	245	245	245	2313,5	2001	350	1301	50	570	550	100	(1)	500	20	100	42	300	80	(2)	665	4	687	
PM(S/H)	/14	22	180L	1236/FN	1644,5	1010,5	274	245	245	245	2353,5	2039	350	1339	50	570	550	100	(1)	500	20	100	42	300	80	(2)	705	4	708	
PM(S/H)	/14	30	200L	1237/GN	1644,5	1010,5	274	245	245	245	2406,5	2074	350	1374	50	600	550	100	(1)	500	20	100	42	300	80	(2)	758	4	770	
PM(S/H)	/14	37	225S	1238/HQ	1644,5	1010,5	274	245	245	245	2441,5	2125	350	1425	70	675	585	100	(1)	535	20	120	42	345	80	(2)	793	4	840	
PM(S/H)	80/15	15	160L	1234/EN	1714,5	1080,5	274	245	245	245	2345,5	2061	350	1361	50	551	550	100	(1)	500	20	100	42	300	80	(2)	627	4	672	
PM(S/H)	/15	18,5	180M	1239/FN	1714,5	1080,5	274	245	245	245	2383,5	2071	350	1371	50	570	550	100	(1)	500	20	100	42	300	80	(2)	665	4	710	
PM(S/H)	/15	22	180L	1240/FN	1714,5	1080,5	274	245	245	245	2423,5	2109	350	1409	50	570	550	100	(1)	500	20	100	42	300	80	(2)	705	4	730	
PM(S/H)	/15	30	200L	1241/GN	1714,5	1080,5	274	245	245	245	2476,5	2144	350	1444	50	600	550	100	(1)	500	20	100	42	300	80	(2)	758	4	792	
PM(S/H)	/15	37	225S	1242/HQ	1714,5	1080,5	274	245	245	245	2511,5	2195	350	1495	70	675	585	100	(1)	535	20	120	42	345	80	(2)	793	4	863	
PM(S/H)	80/16	18,5	180M	1243/FN	1784,5	1150,5	274	245	245	245	2453,5	2141	350	1441	50	570	550	100	(1)	500	20	100	42	300	80	(2)	665	4	732	
PM(S/H)	/16	22	180L	1244/FN	1784,5	1150,5	274	245	245	245	2493,5	2179	350	1479	50	570	550	100	(1)	500	20	100	42	300	80	(2)	705	4	753	
PM(S/H)	/16	30	200L	1245/GN	1784,5	1150,5	274	245	245	245	2546,5	2214	350	1514	50	600	550	100	(1)	500	20	100	42	300	80	(2)	758	4	815	
PM(S/H)	/16	37	225S	1246/HQ	1784,5	1150,5	274	245	245	245	2581,5	2265	400	1465	70	675	585	100	(1)	535	20	120	42	345	80	(2)	793	4	885	

BGAM = Base and coupling
 * = Indicatives values according to the type of motor installed.

- (1) PM=25 bar PMS=25 bar PMH=40 bar
- (2) PM=40 bar PMS=63 bar PMH=100 bar

BGAM = Socle et accouplement
 * = Valeurs indicatives en fonction de la marque du moteur utilisé.

- (1) PM=25 bar PMS=25 bar PMH=40 bar
- (2) PM=40 bar PMS=63 bar PMH=100 bar

BGAM = Base giunto e coprigiunto
 * = Valori indicativi in funzione della marca di motore utilizzato.

- (1) PM=25 bar PMS=25 bar PMH=40 bar
- (2) PM=40 bar PMS=63 bar PMH=100 bar