

NCD 4P65-250

1450 n [min⁻¹]

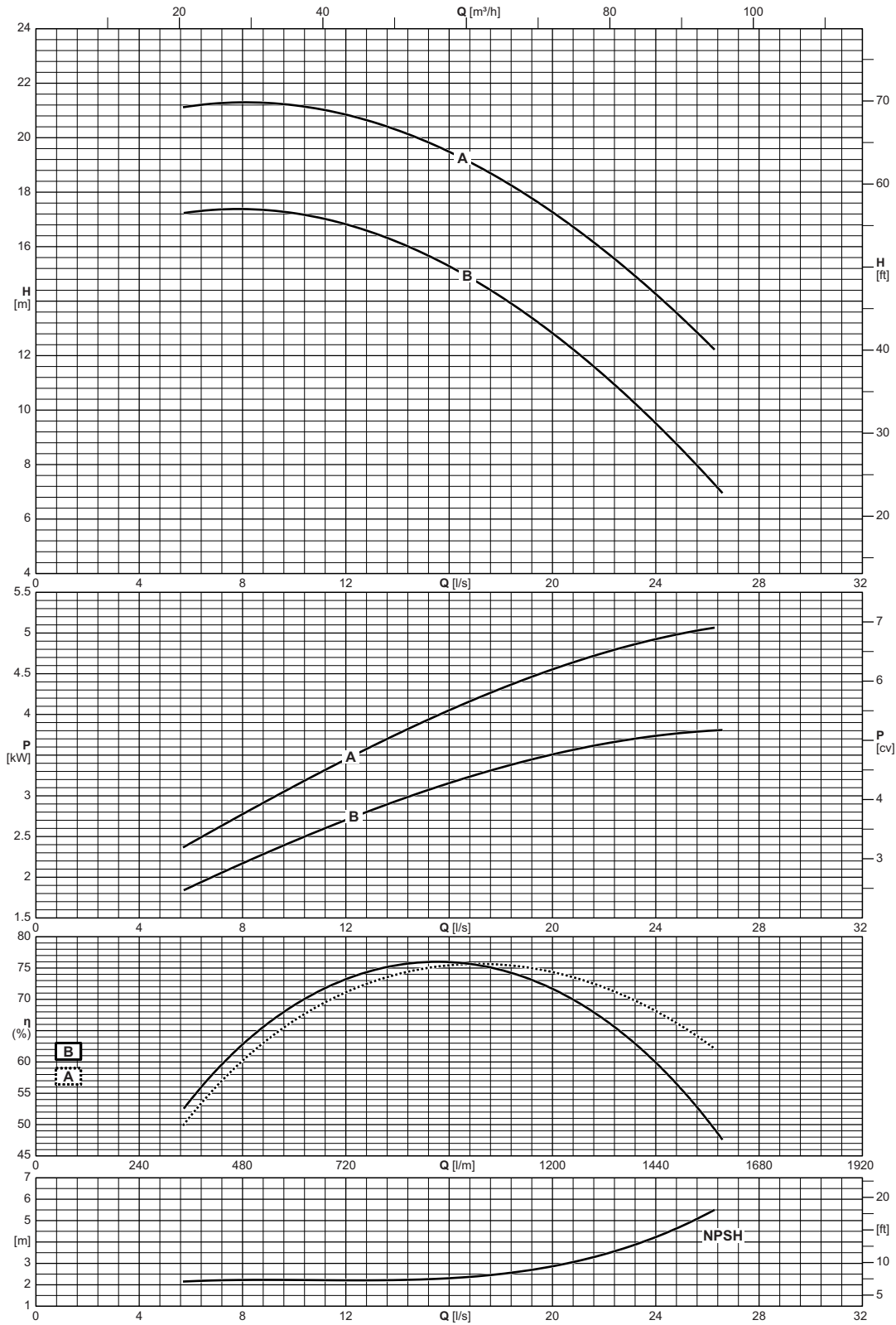

Operating data
 Caracteristiques de fonctionnement
 Caratteristiche di funzionamento



Type Type Tipo	Inlet maximum pressure Pression maximale en aspiration Pressione massima in aspirazione
NCD4P65-250	[bar] 10

Overall dimensions and weights
 Dimensions d'encombrement et poids
 Dimensioni di ingombro e pesi



Type Type Tipo	Weight Poids Peso [kg]	Dimensions pump Dimensions pompe Dimensioni pompa										Duck foot pedestal dimensions Dimensiones pieds de soutien Dimensioni piedi di appoggio							Shaft projection Saillie d'arbre Sporgenza d'albero				
		DNa	DNm	r	s	a	f	h1	h2	l2	o2	b	m1	m2	n1	n2	k	w	s1	s2	d	l	T
		[mm]																					
NCD(S)2P32-125	26	50	32	10	10	80	360	112	140	97	93	50	100	70	190	140	110	260	ø 14	ø 14	24	50	50
NCD(S)2P32-160	33	50	32	10	10	80	360	132	160	120	120	50	100	70	240	190	110	260	ø 14	ø 14	24	50	50
NCD(S)2P32L-160	31	50	32	10	10	80	360	132	160	120	120	50	100	70	240	190	110	260	ø 14	ø 14	24	50	50
NCD(S)2P32L-200	40	50	32	10	10	80	360	160	180	140	140	50	100	70	265	212	110	260	ø 14	ø 14	24	50	50
NCD(S)2P32-200	38	50	32	10	10	80	360	160	180	140	140	50	100	70	240	190	110	260	ø 14	ø 14	24	50	50
NCD(S)2P40-125	28	65	40	10	10	80	360	112	140	113	100	50	100	70	210	160	110	260	ø 14	ø 14	24	50	65
NCD(S)2P40-160	33	65	40	10	10	80	360	132	160	119	119	50	100	70	240	190	110	260	ø 14	ø 14	24	50	65
NCD(S)2P40-200	40	65	40	10	10	100	360	160	180	140	140	50	100	70	265	212	110	260	ø 14	ø 14	24	50	65
NCD(S)2P40-250	55	65	40	10	10	100	360	180	225	175	175	65	125	95	320	250	110	260	ø 14	ø 14	24	50	65
NCD(S)2P50-125	34	65	50	10	10	100	360	132	160	137	121	50	100	70	240	190	110	260	ø 14	ø 14	24	50	65
NCD(S)2P50-160	33	65	50	10	10	100	360	160	180	141	127	50	100	70	265	212	110	260	ø 14	ø 14	24	50	65
NCD(S)2P50-200	44	65	50	10	10	100	360	160	200	153	140	50	100	70	265	212	110	260	ø 14	ø 14	24	50	65
NCD(S)2P50-250	57	65	50	10	10	100	360	180	225	175	175	65	125	95	320	250	110	260	ø 14	ø 14	24	50	65
NCD(S)2P65-125	38	80	65	10	10	100	360	160	180	155	134	65	125	95	280	212	110	260	ø 14	ø 14	24	50	80
NCD(S)2P65-160	40	80	65	10	10	100	360	160	200	172	150	65	125	95	280	212	110	260	ø 14	ø 14	24	50	80
NCD(S)2P65-200	48	80	65	10	10	100	360	180	225	175	155	65	125	95	320	250	110	260	ø 14	ø 14	24	50	80
NCD(S)2P65-250	88	80	65	10	10	100	470	200	250	190	175	80	160	120	360	280	110	340	ø 18	ø 14	24	50	80
NCD(S)2P80-160	48	100	80	10	10	125	360	180	225	193	165	65	125	95	320	250	110	260	ø 14	ø 14	24	50	100
NCD(S)2P80-200	80	100	80	10	10	125	470	180	250	194	170	65	125	95	345	280	110	340	ø 14	ø 14	32	80	100
NCD(S)2P80-250	92	100	80	10	10	125	470	200	280	210	191	80	160	120	400	315	110	340	ø 18	ø 14	32	80	100
NCD(S)2P100-200	83	125	100	10	10	125	470	200	280	212	180	80	160	120	360	280	110	340	ø 18	ø 14	32	80	125
NCD(S)2P100-250	103	125	100	10	10	140	470	225	280	233	205	80	160	120	400	315	110	340	ø 18	ø 14	32	80	125
NCD(S)4P32-125	25	50	32	10	10	80	360	112	140	97	93	50	100	70	190	140	110	260	ø 14	ø 14	24	50	50
NCD(S)4P32-160	33	50	32	10	10	80	360	132	160	120	120	50	100	70	240	190	110	260	ø 14	ø 14	24	50	50
NCD(S)4P32-200	37	50	32	10	10	80	360	160	180	140	140	50	100	70	240	190	110	260	ø 14	ø 14	24	50	50
NCD(S)4P40-160	33	65	40	10	10	80	360	132	160	119	119	50	100	70	240	190	110	260	ø 14	ø 14	24	50	65
NCD(S)4P40-200	40	65	40	10	10	100	360	160	180	140	140	50	100	70	265	212	110	260	ø 14	ø 14	24	50	65
NCD(S)4P40-250	55	65	40	10	10	100	360	180	225	175	175	65	125	95	320	250	110	260	ø 14	ø 14	24	50	65
NCD(S)4P50-125	34	65	50	10	10	100	360	132	160	137	121	50	100	70	240	190	110	260	ø 14	ø 14	24	50	65
NCD(S)4P50-160	33	65	50	10	10	100	360	160	180	141	127	50	100	70	265	212	110	260	ø 14	ø 14	24	50	65
NCD(S)4P50-200	44	65	50	10	10	100	360	160	200	153	140	50	100	70	265	212	110	260	ø 14	ø 14	24	50	65
NCD(S)4P50-250	57	65	50	10	10	100	360	180	225	175	175	65	125	95	320	250	110	260	ø 14	ø 14	24	50	65
NCD(S)4P65-125	38	80	65	10	10	100	360	160	180	155	134	65	125	95	280	212	110	260	ø 14	ø 14	24	50	80
NCD(S)4P65-160	40	80	65	10	10	100	360	160	200	172	150	65	125	95	280	212	110	260	ø 14	ø 14	24	50	80
NCD(S)4P65-200	48	80	65	10	10	100	360	180	225	175	155	65	125	95	320	250	110	260	ø 14	ø 14	24	50	80
NCD(S)4P65-250	89	80	65	10	10	100	470	200	250	190	175	80	160	120	360	280	110	340	ø 18	ø 14	24	50	80
NCD(S)4P65-315	131	80	65	10	10	125	470	225	280	220	220	80	160	120	400	315	110	340	ø 18	ø 14	32	80	80
NCD(S)4P80-160	48	100	80	10	10	125	360	180	225	193	165	65	125	95	320	250	110	260	ø 14	ø 14	24	50	100
NCD(S)4P80-200	80	100	80	10	10	125	470	180	250	194	170	65	125	95	345	280	110	340	ø 14	ø 14	32	80	100
NCD(S)4P80-250	92	100	80	10	10	125	470	200	280	210	191	80	160	120	400	315	110	340	ø 18	ø 14	32	80	100
NCD(S)4P80-315	128	100	80	10	10	125	470	250	315	232	220	80	160	120	400	315	110	340	ø 18	ø 14	32	80	100
NCD(S)4P80-400	184	100	80	10	10	125	530	280	355	268	268	80	160	120	435	355	110	370	ø 18	ø 14	42	110	100
NCD(S)4P100-200	83	125	100	10	10	125	470	200	280	212	180	80	160	120	360	280	110	340	ø 18	ø 14	32	80	125
NCD(S)4P100-250	103	125	100	10	10	140	470	225	280	233	205	80	160	120	400	315	110	340	ø 18	ø 14	32	80	125
NCD(S)4P100-315	138	125	100	10	10	140	470	250	315	250	230	80	160	120	400	315	110	340	ø 18	ø 14	32	80	125

Selection - dimensions and weights for base mounted electric pumps
 Sélection - dimensions et poids des électropompes sur socle
 Selezione - dimensioni e pesi elettropompe su base

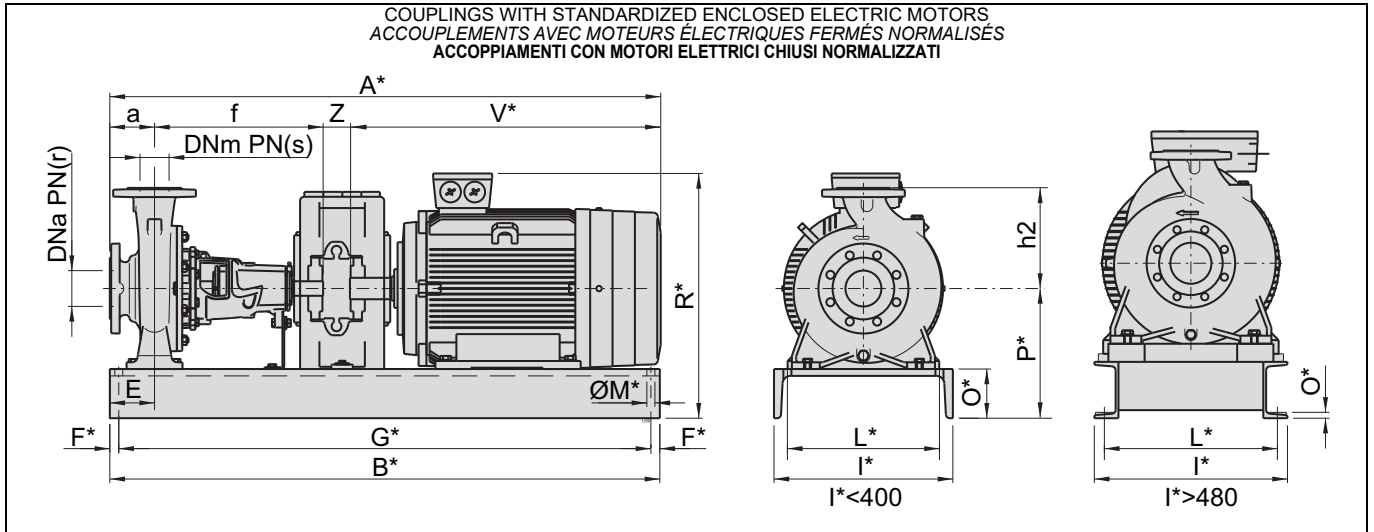

Pump Pompe Pompa		Motor Moteur Motore		Weight Poids Peso	BGAD	A *	B *	E	F *	G *	I *	L *	M *	O *	P *	R *	V *	Z	a	f	h2	r	s		
Type Type Tipo	DNa [mm]	DNm	[kW]	Size Taille Grand.	[kg]	Type Type Tipo	[mm]																		
NCD4P32-200	50	32	0,75	80M4	80	1011	773	780	90	15	750	240	180	∅ 14	85	245	370	295	38	80	360	180	10	10	
NCD4P40-160	65	40	0,75	80M4	75	1016	773	780	90	15	750	240	180	∅ 14	85	217	342	295	38	80	360	160	10	10	
NCD4P40-200	65	40	1,1	90S4	101	1020	853	880	100	15	850	300	240	∅ 14	100	260	398	355	38	100	360	180	10	10	
NCD4P40-250	65	40	3	100L4	146	1023	914	880	100	15	850	350	290	∅ 14	100	280	430	405	49	100	360	225	10	10	
NCD4P50-125	65	50	0,75	112M2	76	1016	793	780	90	15	750	240	180	∅ 14	85	217	342	295	38	100	360	160	10	10	
NCD4P50-160	65	50	1,1	90S4	95	1020	853	880	100	15	850	300	240	∅ 14	100	260	398	355	38	100	360	180	10	10	
NCD4P50-200	65	50	2,2	100L4	118	1009	914	880	90	15	850	300	240	∅ 14	100	260	410	405	49	100	360	200	10	10	
NCD4P50-250	65	50	4	112M4	157	1025	949	880	100	15	850	350	290	∅ 14	100	280	452	440	49	100	360	225	10	10	
NCD4P65-125	80	65	1,1	90S4	99	1020	853	880	100	15	850	300	240	∅ 14	100	260	398	355	38	100	360	180	10	10	
NCD4P65-160	80	65	1,5	90L4	105	1020	883	880	100	15	850	300	240	∅ 14	100	260	398	385	38	100	360	200	10	10	
NCD4P65-200	80	65	3	100L4	139	1023	914	880	100	15	850	350	290	∅ 14	100	280	430	405	49	100	360	225	10	10	
NCD4P65-250	80	65	5,5	132S4	220	1032	1045	1030	130	20	990	400	340	∅ 18	110	310	502	455	20	100	470	250	10	10	
NCD4P65-315	80	65	11	160M4	373	1034	1226	1230	130	20	1190	400	340	∅ 18	110	335	586	627	4	125	470	280	10	10	
NCD4P80-160	100	80	2,2	100L4	135	1023	939	880	100	15	850	350	290	∅ 14	100	280	430	405	49	125	360	225	10	10	
NCD4P80-200	100	80	4	112M4	187	1039	1084	1020	100	15	990	350	290	∅ 14	100	280	452	440	49	125	470	250	10	10	
NCD4P80-250	100	80	7,5	132M4	231	1032	1105	1030	130	20	990	400	340	∅ 18	110	310	502	490	20	125	470	280	10	10	
NCD4P80-315	100	80	15	160L4	384	1043	1226	1230	130	20	1190	400	340	∅ 18	110	360	611	627	4	125	470	315	10	10	
NCD4P80-400	100	80	30	200L4	559	1046	1440	1250	115	205	840	480	430	∅ 24	16	445	745	758	27	125	530	355	10	10	
NCD4P100-200	125	100	5,5	132S4	214	1032	1070	1030	130	20	990	400	340	∅ 18	110	310	502	455	20	125	470	280	10	10	
NCD4P100-250	125	100	11	160M4	346	1034	1241	1230	130	20	1190	400	340	∅ 18	110	335	586	627	4	140	470	280	10	10	
NCD4P100-315	125	100	18,5	180M4	447	1044	1335	1360	130	20	1320	400	340	∅ 18	110	360	630	665	60	140	470	315	10	10	
NCD4P100-400	125	100	37	225S4	621	1055	1467	1250	115	205	840	480	430	∅ 24	16	445	775	793	4	140	530	355	10	10	
NCD4P125-250	150	125	15	160L4	380	1043	1241	1230	130	20	1190	400	340	∅ 18	110	360	611	627	4	140	470	355	10	10	
NCD4P125-315	150	125	30	200L4	563	1054	1455	1250	115	205	840	480	430	∅ 24	16	445	745	758	27	140	530	355	10	10	
NCD4P125-400	150	125	55	250M4	843	1058	1554	1400	115	230	940	510	450	∅ 24	17,5	540	915	880	4	140	530	400	10	10	
NCD4P150-315	200	150	37	225S4	623	1061	1487	1250	115	205	840	480	430	∅ 24	16	445	775	793	4	160	530	400	10	10	
NCD4P150-400	200	150	75	280S4	1040	1064	1707	1400	115	230	940	510	450	∅ 24	17,5	540	935	1013	4	160	530	450	10	10	

BGAD = Base and coupling BGAD = Socle et accouplement BGAD = Base e giunto
 * = Indicatives values according to the type of motor installed. * = Valeurs indicatives en fonction de la marque du moteur utilisé. * = Valori indicativi in funzione della marca di motore utilizzato.
 ○ Motor in IE4 efficiency class according to EU REGULATION 2019/1781. Available in other efficiency classes for non-EU markets. ○ Moteur en classe de rendement IE4 conformément au RÈGLEMENT UE2019/1781. Disponibilité en différentes classes de rendement pour les marchés hors UE. ○ Motore in classe di efficienza IE4 in conformità al REGOLAMENTO UE2019/1781. Disponibili in altre classi di efficienza per mercati extra UE.