

ELECTRIC BOREHOLE PUMPS
ELECTROPOMPES IMMERGEES
ELETTROPOMPE SOMMERSE

E6 - 12

Poles
Poles 2 50 Hz
Poli



ENDURANCE
+RESISTANCE +PERFORMANCE

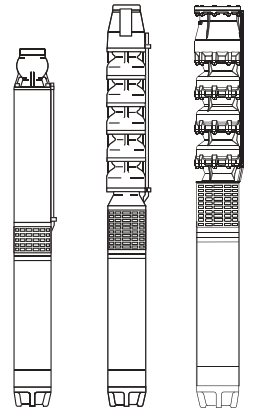

caprari

pumping power

ISO 9001
ISO 14001
ISO 45001
BUREAU VERITAS
Certification



	Page - Page - Pagina
Key to codes; <i>Explication des désignations</i> ; Esemplificazione delle sigle	3
Pump construction and materials; <i>Construction de la pompe et matériaux</i> ; Costruzione pompa e materiali	5
Motor construction and materials; <i>Construction du moteur et matériaux</i> ; Costruzione motore e materiali	9
General notes about the wet end; <i>Remarques générales partie hydraulique</i> ; Note generali parte idraulica	14
Motor general remarks; <i>Notes générales moteur</i> ; Note generali motore	15
Performance ranges; <i>Champs de performances</i> ; Campi di prestazioni	17
Operating data; <i>Caractéristiques de fonctionnement</i> ; Caratteristiche di funzionamento	19
Friction losses; <i>Pertes de charge</i> ; Perdite di carico	53
Motor operating data, <i>dimensions and weights</i> ; <i>Caractéristiques de fonctionnement, dimensions et poids moteurs</i> ; Caratteristiche di funzionamento, dimensioni e pesi motori	54
Dynamic momentum of the wet end; <i>Moment dynamique partie hydraulique</i> ; Momento dinamico parte idraulica	60
Dynamic momentum of the motor; <i>Moment dynamique moteur</i> ; Momento dinamico motore	61
Feeding cables; <i>Câbles d'alimentation</i> ; Cavi di alimentazione	62
Max admitted length - <i>Longueur maxi admise</i> - Lunghezze massime ammissibili	67
Generator power; <i>Puissance du generateur</i> ; Potenza del generatore	71
Common electric formulae; <i>Formules d'usage commun</i> ; Formule di uso comune	72
Electrical tolerances; <i>Tolérances électriques</i> ; Tolleranze elettriche	73
Reactive power compensation; <i>Compensation de la puissance réactive</i> ; Compensazione della potenza reattiva	74
Accessories; <i>Accessoires</i> ; Accessori	75
Technical data; <i>Donnes techniques</i> ; Dati tecnici	77

Key to codes
Explication des désignations
Esemplificazione delle sigle

1) Electric pump code - Désignation de l'électropompe - Sigla elettropompa:

Ex. - Ex. - Es.

E6RX30/36+MACW620A

E8PX135/8A+MACX8100

E6SX55/21A+MACW660B

E10PX200/7AB+MACW10100

E12PXE430/7D+MW14380

2) Examples of wet end identification codes - Identification du sigle des partie hydraulique - Esemplificazione sigle parti idrauliche

E6RX30/36A:

E	=	Series - Série - Serie	E 6 R X
6	=	DN in inch - DN en pouces - DN in pollici	30
R	=	Radial impeller - Roue radiale - Girante radiale	-6
X	=	Stainless steel - Acier inox - Acciaio inox	/36
30	=	Hydraulic identification number - Numéro identifiant hydraulique - Numero identificativo idraulica	A
-6	=	Coupling flange motor - Bride d'accouplement moteur - Flangia accoppiamento motore	-V
/36	=	Number of stages - Nombre d'étages - Numero degli stadi	
A	=	Impeller trimming - Rognage roue - Riduzione girante	
-V	=	Unit used at 50 Hz - Ensemble avec utilization a 50 Hz - Gruppo con impiego a 50 Hz	

E6SX55/21A:

E	=	Series - Série - Serie	E 6 S X
6	=	DN in inch - DN en pouces - DN in pollici	55
S	=	Mixed flow impeller - Roue demi-axiale - Girante semiassiale	-6
X	=	Stainless steel - Acier inox - Acciaio inox	/21
55	=	Hydraulic identification number - Numéro identifiant hydraulique - Numero identificativo idraulica	A
-6	=	Coupling flange motor - Bride d'accouplement moteur - Flangia accoppiamento motore	-V
/21	=	Number of stages - Nombre d'étages - Numero degli stadi	
A	=	Impeller trimming - Rognage roue - Riduzione girante	
-V	=	Unit used at 50 Hz - Ensemble avec utilization a 50 Hz - Gruppo con impiego a 50 Hz	

E8PX135/8A:

E.PX	=	Series - Série - Serie	E.PX 8
8	=	DN in inch - DN en pouces - DN in pollici	135
135	=	Hydraulic identification number - Numéro identifiant hydraulique - Numero identificativo idraulica	-8
-8	=	Coupling flange motor - Bride d'accouplement moteur - Flangia accoppiamento motore	/8
/8	=	Number of stages - Nombre d'étages - Numero degli stadi	A
A	=	Impeller trimming - Rognage roue - Riduzione girante	-V
-V	=	Unit used at 50 Hz - Ensemble avec utilization a 50 Hz - Gruppo con impiego a 50 Hz	

E10PX200/7AB:

E.PX	=	Series - Série - Serie	E.PX 10
10	=	DN in inch - DN en pouces - DN in pollici	200
200	=	Hydraulic identification number - Numéro identifiant hydraulique - Numero identificativo idraulica	-10
-10	=	Coupling flange motor - Bride d'accouplement moteur - Flangia accoppiamento motore	/7
/7	=	Number of stages - Nombre d'étages - Numero degli stadi	A
AB	=	Impeller trimming - Rognage roue - Riduzione girante	-B
-V	=	Unit used at 50 Hz - Ensemble avec utilization a 50 Hz - Gruppo con impiego a 50 Hz	

E12PXE430/7D:

E.PX	=	Series - Série - Serie	E.PX 12
12	=	DN in inch - DN en pouces - DN in pollici	E
E	=	With hydraulic balancing - Avec équilibrage hydraulique - Con equilibratura idraulica	430
430	=	Hydraulic identification number - Numéro identifiant hydraulique - Numero identificativo idraulica	-12
-12	=	Coupling flange motor - Bride d'accouplement moteur - Flangia accoppiamento motore	/7
/7	=	Number of stages - Nombre d'étages - Numero degli stadi	D
D	=	Impeller trimming - Rognage roue - Riduzione girante	-V
-V	=	Unit used at 50 Hz - Ensemble avec utilization a 50 Hz - Gruppo con impiego a 50 Hz	

Key to codes
Explication des désignations
Esemplificazione delle sigle

3) Examples of submersible motor identification codes - *Identification du sigle des moteurs immergés* - *Esemplificazione sigle motori sommersi*

MACW620A/3A-8: MAC W 6 20 /3 A -8
MAC = Submersible motor - *Moteur immergé* - **Motore sommerso**
W = Stainless steel - *Acier inox* - **Acciaio inox**
6 = Nominal diameter in inches - *Diamètre nominal en pouces* - **Diametro nominale in pollici**
20 = Nominal power in HP - *Puissance nominale en HP* - **Potenza nominale in HP**
/3 = Generational code - *Code générationnel* - **Codice generazionale**
A = Hi Tech
-8 = Constructional features of electric motor - *Caractéristiques de fabrication*
moteur électrique - **Caratteristiche costruttive motore elettrico**

MACW660/3B-8: MAC W 6 60 /3 B -8
MAC = Submersible motor - *Moteur immergé* - **Motore sommerso**
W = Stainless steel - *Acier inox* - **Acciaio inox**
6 = Nominal diameter in inches - *Diamètre nominal en pouces* - **Diametro nominale in pollici**
60 = Nominal power in HP - *Puissance nominale en HP* - **Potenza nominale in HP**
/3 = Generational code - *Code générationnel* - **Codice generazionale**
B = Hi Tech Desert
-8 = Constructional features of electric motor - *Caractéristiques de fabrication*
moteur électrique - **Caratteristiche costruttive motore elettrico**

MACW8100-8: MAC W 8 100 -8
MAC = Submersible motor - *Moteur immergé* - **Motore sommerso**
W = Stainless steel - *Acier inox* - **Acciaio inox**
8 = Nominal diameter in inches - *Diamètre nominal en pouces* - **Diametro nominale in pollici**
100 = Nominal power in HP - *Puissance nominale en HP* - **Potenza nominale in HP**
-8 = Constructional features of electric motor - *Caractéristiques de fabrication*
moteur électrique - **Caratteristiche costruttive motore elettrico**

MACW10100-8: MAC W 10 100 -8
MAC = Submersible motor - *Moteur immergé* - **Motore sommerso**
W = Stainless steel - *Acier inox* - **Acciaio inox**
10 = Nominal diameter in inches - *Diamètre nominal en pouces* - **Diametro nominale in pollici**
100 = Nominal power in HP - *Puissance nominale en HP* - **Potenza nominale in HP**
-8 = Constructional features of electric motor - *Caractéristiques de fabrication*
moteur électrique - **Caratteristiche costruttive motore elettrico**

MW14380-8: M W 14 380 -8
M = Submersible motor - *Moteur immergé* - **Motore sommerso**
W = Stainless steel - *Acier inox* - **Acciaio inox**
14 = Nominal diameter in inches - *Diamètre nominal en pouces* - **Diametro nominale in pollici**
380 = Nominal power in HP - *Puissance nominale en HP* - **Potenza nominale in HP**
-8 = Constructional features of electric motor - *Caractéristiques de fabrication*
moteur électrique - **Caratteristiche costruttive motore elettrico**

Pump construction and materials
 Construction de la pompe et matériaux
 Costruzione pompa e materiali

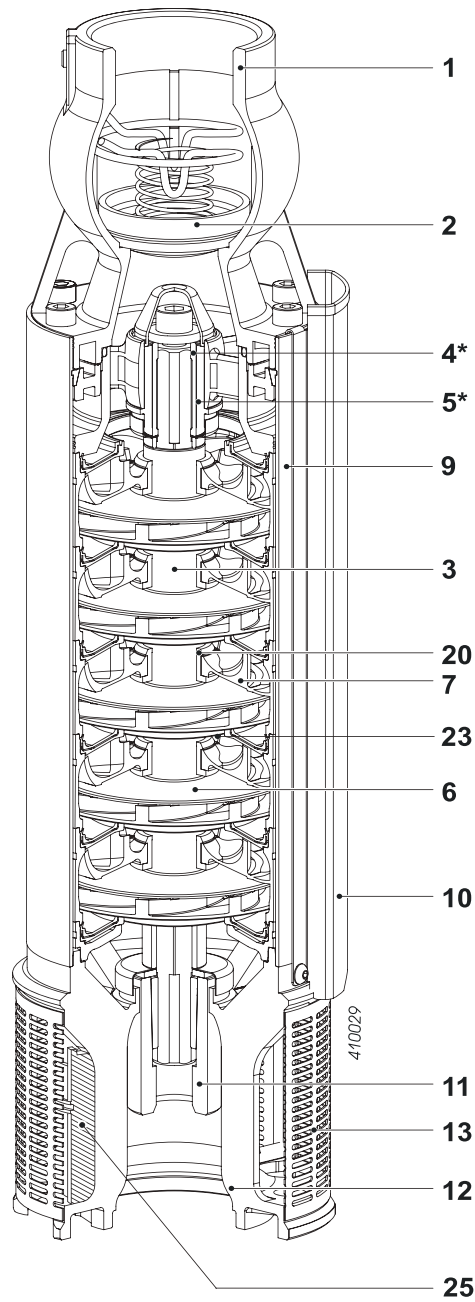

Pos.	Parts	Materials	Nomenclature	Matériaux	Nomenclatura	Materiale
1	Valve casing	Stainless steel	Corps du clapet	Acier inox	Corpo valvola	Acciaio inox
2	Conical valve	Stainless steel	Clapet	Acier inox	Clapet	Acciaio inox
3	Pump shaft	Stainless steel	Arbre de pompe	Acier inox	Albero	Acciaio inox
4	Shaft sleeve	Stainless steel	Entretoise d'arbre	Acier inox	Bussola albero	Acciaio inox
5 (20)	Shaft bearing bush	Rubber	Coussinet arbre pompe	Caoutchouc	Cuscinetto albero	Gomma
6	Impeller	Stainless steel	Roue	Acier inox	Girante	Acciaio inox
7	Diffuser	Stainless steel	Diffuseur	Acier inox	Diffusore	Acciaio inox
9	Stage casing	Stainless steel	Corps d'Etage	Acier inox	Mantello	Acciaio inox
10	Cable guard	Stainless steel	Gouttière de protection	Acier inox	Tegolo protezione cavi	Acciaio inox
11	Coupling	Stainless steel	Accouplement rigide	Acier inox	Giunto rigido	Acciaio inox
12	Suction casing	Stainless steel	Pièce d'aspiration	Acier inox	Supporto aspirazione	Acciaio inox
13	Strainer	Stainless steel	Crépine	Acier inox	Succheruola	Acciaio inox
23	Wear ring	Stainless steel/rubber	Bague d'usure	Acier inox/caoutchouc	Anello sede girante	Acciaio inox/gomma
25	Defender®	.	Defender®	.	Defender®	.

Bolts and nuts in stainless steel.

Visserie en acier inox

Bulloneria in acciaio inox

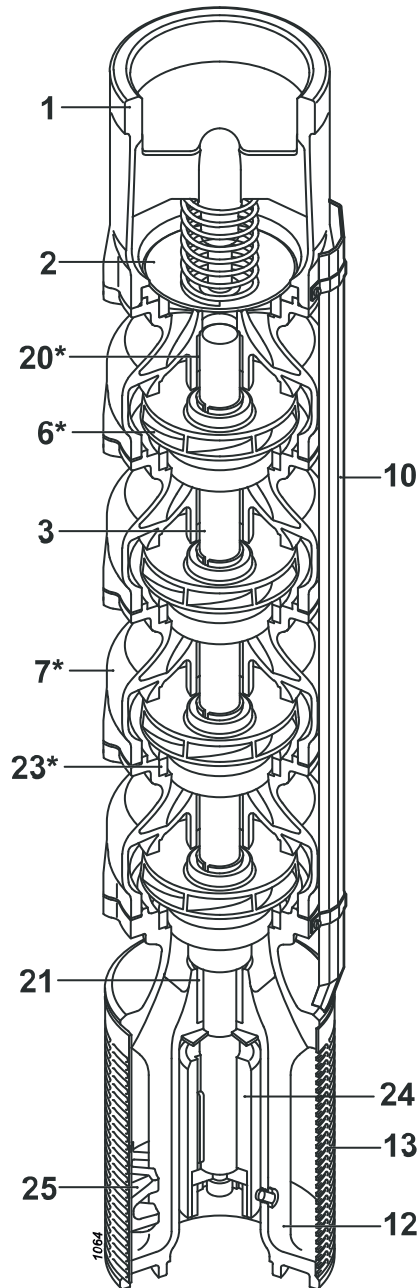

Pos.	Parts	Materials	Nomenclature	Matériaux	Nomenclatura	Materiale
1	Valve casing	Stainless steel	Corps du clapet	Acier inox	Corpo valvola	Acciaio inox
2	Conical valve	Stainless steel	Clapet	Acier inox	Clapet	Acciaio inox
3	Pump shaft	Stainless steel	Arbre de pompe	Acier inox	Albero	Acciaio inox
6	Impeller	Stainless steel	Roue	Acier inox	Girante	Acciaio inox
7	Diffuser unit	Stainless steel	Élément diffuseur	Acier inox	Elemento diffusore	Acciaio inox
10	Cable guard	Stainless steel	Gouttière de protection	Acier inox	Tegolo protezione cavi	Acciaio inox
12	Suction casing	Stainless steel	Pièce d'aspiration	Acier inox	Supporto aspirazione	Acciaio inox
13	Strainer	Stainless steel	Crépine	Acier inox	Succheruola	Acciaio inox
20	Shaft bearing bush	Stainless steel/rubber	Coussinet arbre pompe	Acier inox/caoutchouc	Cuscinetto albero	Acciaio inox/gomma
21	Bearing bush	Bronze	coussinet	Bronze	Bronzina	Bronzo
23	Wear ring	Stainless steel/rubber	Bague d'usure	Acier inox/caoutchouc	Anello sede girante	Acciaio inox/gomma
24	Coupling	Stainless steel	Accouplement rigide	Acier inox	Giunto rigido	Acciaio inox
25	Defender®	.	Defender®	.	Defender®	.

Bolts and nuts in stainless steel.

Visserie en acier inox

Bulloneria in acciaio inox

Pump construction and materials
 Construction de la pompe et matériaux
 Costruzione pompa e materiali

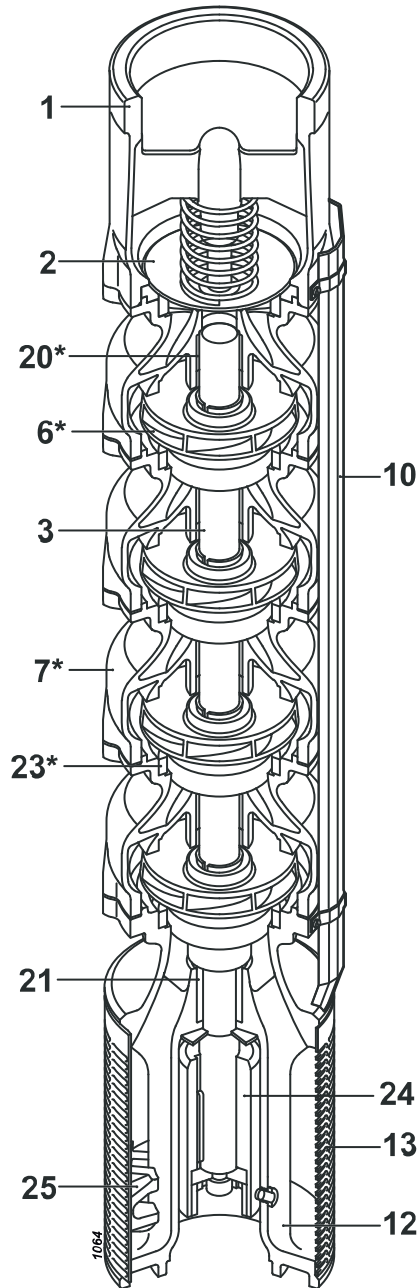

Pos.	Parts	Materials	Nomenclature	Matériaux	Nomenclatura	Materiale
1	Valve casing	Stainless steel	Corps du clapet	Acier inox	Corpo valvola	Acciaio inox
2	Conical valve	Stainless steel	Clapet	Acier inox	Clapet	Acciaio inox
3	Pump shaft	Stainless steel	Arbre de pompe	Acier inox	Albero	Acciaio inox
6	Impeller	Stainless steel	Roue	Acier inox	Girante	Acciaio inox
7	Diffuser unit	Stainless steel	Élément diffuseur	Acier inox	Elemento diffusore	Acciaio inox
10	Cable guard	Stainless steel	Gouttière de protection	Acier inox	Tegolo protezione cavi	Acciaio inox
12	Suction casing	Stainless steel	Pièce d'aspiration	Acier inox	Supporto aspirazione	Acciaio inox
13	Strainer	Stainless steel	Crépine	Acier inox	Succheruola	Acciaio inox
20 (21)	Shaft bearing bush	Stainless steel/rubber	Coussinet arbre pompe	Acier inox/caoutchouc	Cuscinetto albero	Acciaio inox/gomma
23	Wear ring	Stainless steel/rubber	Bague d'usure	Acier inox/caoutchouc	Anello sede girante	Acciaio inox/gomma
24	Coupling	Stainless steel	Accouplement rigide	Acier inox	Giunto rigido	Acciaio inox
25	Defender®	.	Defender®	.	Defender®	.

Bolts and nuts in stainless steel.

Visserie en acier inox

Bulloneria in acciaio inox

E6-12

E12PX

Pump construction and materials
Construction de la pompe et matériaux
Costruzione pompa e materiali

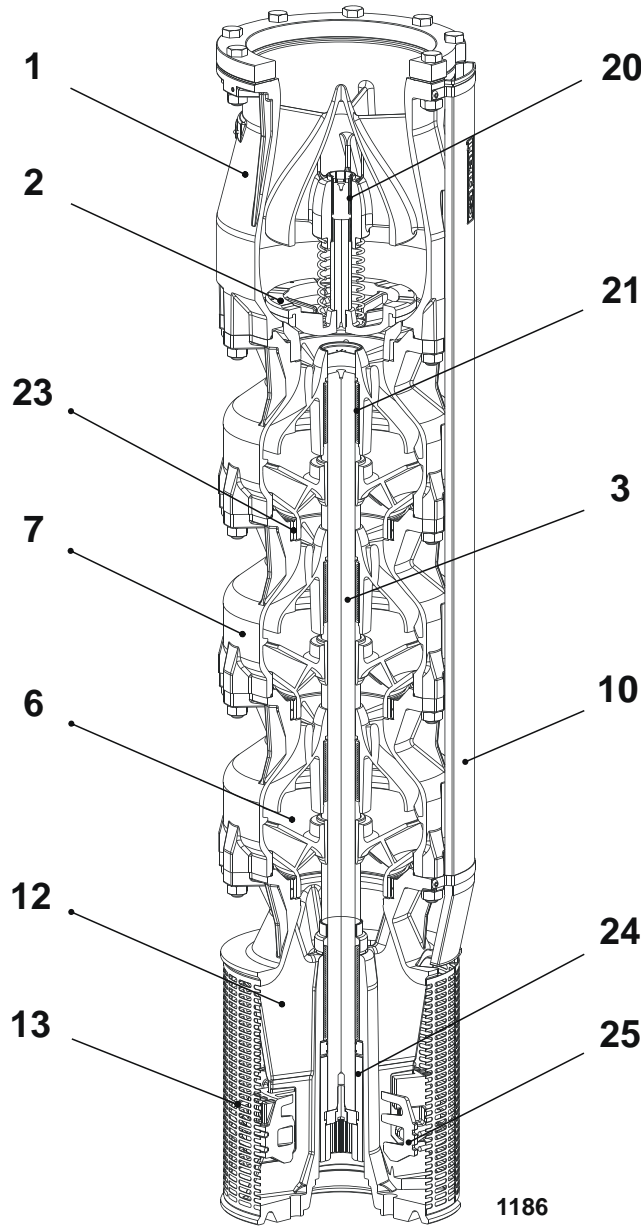

1186

Pos.	Parts	Materials	Nomenclature	Matériaux	Nomenclatura	Materiale
1	Valve casing	Stainless steel	Corps du clapet	Acier inox	Corpo valvola	Acciaio inox
2	Conical valve	Stainless steel	Clapet	Acier inox	Clapet	Acciaio inox
3	Pump shaft	Stainless steel	Arbre de pompe	Acier inox	Albero	Acciaio inox
6	Impeller	Stainless steel	Roue	Acier inox	Girante	Acciaio inox
7	Diffuser unit	Stainless steel	Élément diffuseur	Acier inox	Elemento diffusore	Acciaio inox
10	Cable guard	Stainless steel	Gouttière de protection	Acier inox	Tegolo protezione cavi	Acciaio inox
12	Suction casing	Stainless steel	Pièce d'aspiration	Acier inox	Supporto aspirazione	Acciaio inox
13	Strainer	Stainless steel	Crépine	Acier inox	Succheruola	Acciaio inox
20 (21)	Shaft bearing bush	Stainless steel/rubber	Coussinet arbre pompe	Acier inox/caoutchouc	Cuscinetto albero	Acciaio inox/gomma
23	Wear ring	Stainless steel/rubber	Bague d'usure	Acier inox/caoutchouc	Anello sede girante	Acciaio inox/gomma
24	Coupling	Stainless steel	Accouplement rigide	Acier inox	Giunto rigido	Acciaio inox
25	Defender®	.	Defender®	.	Defender®	.

Bolts and nuts in stainless steel.

Visserie en acier inox

Bulloneria in acciaio inox

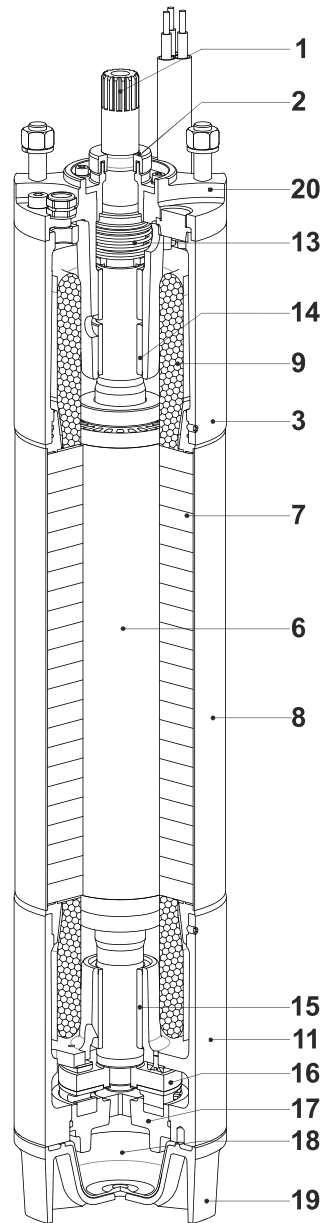

Pos.	Parts	Materials	Nomenclature	Matériaux	Nomenclatura	Materiale
1	Shaft	Stainless steel	Arbre	Acier inox	Albero	Acciaio inox
2	Sand guard	Rubber	para-sable	Caoutchouc	Parasabbia	Gomma
6	Rotor	Electrical steel	Rotor	Tôle magnétique	Rotore	Lamierino magnetico
7	Stator	Electrical steel	Stator	Tôle magnétique	Statore	Lamierino magnetico
8	Stator shell	Stainless steel	Chemise de stator	Acier inox	Camicia statore	Acciaio inox
9	Winding	Green wire	Bobinage	Green wire	Avvolgimento	Green wire
11	Lower bracket	Cast iron	Support inférieur	Fonte grise	Supporto inferiore	Ghisa grigia
13	Mechanical seal	Silicon carbide/ silicon carbide	Garniture mécanique	Carbure de silicium/ carbure de silicium	Tenuta meccanica	Carburo di silicio/ carburo di silicio
14 (15)	Bearing	Graphite	Coussinet	Graphite	Cuscinetto	Grafite
16	Thrust-bearing	Brass/Synthetic compound	Butée	Laiton/Composé synthétique	Reggispinta	Ottone/ Composito sintetico
17	Thrust-bearing foot slip	Cast iron	Support butée	Fonte grise	Supporto reggispinta	Ghisa grigia
18	Diaphragm	Rubber	Membrane	Caoutchouc	Membrana	Gomma
19	Diaphragm cover	Technopolymer	Couvercle de membrane	Polymère technique	Coperchio membrana	Tecnopolimero
20	Upper bracket	Stainless steel	Support supérieur	Acier inox	Supporto superiore	Acciaio inox

Bolts and nuts in stainless steel.

Visserie en acier inox

Bulloneria in acciaio inox

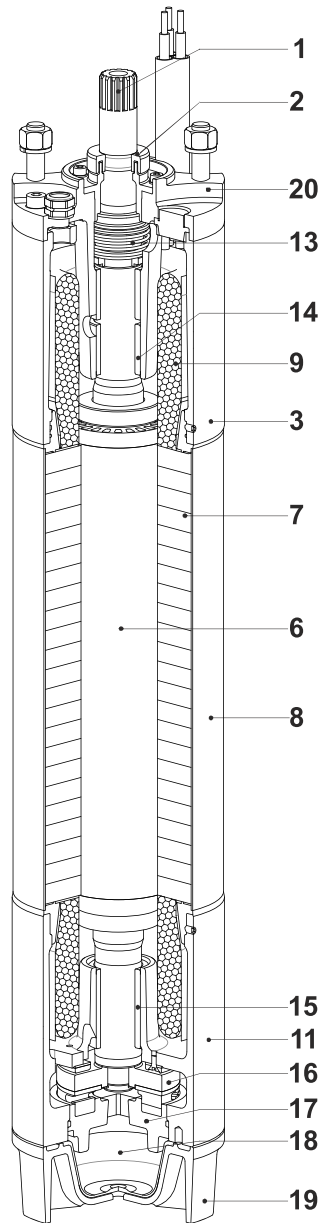

Pos.	Parts	Materials	Nomenclature	Matériaux	Nomenclatura	Materiale
1	Shaft	Stainless steel	Arbre	Acier inox	Albero	Acciaio inox
2	Sand guard	Rubber	para-sable	Caoutchouc	Parasabbia	Gomma
3	Upper cover	Stainless steel	Couvercle supérieur	Acier inox	Coperchio superiore	Acciaio inox
6	Rotor	Electrical steel	Rotor	Tôle magnétique	Rotore	Lamierino magnetico
7	Stator	Electrical steel	Stator	Tôle magnétique	Statore	Lamierino magnetico
8	Stator shell	Stainless steel	Chemise de stator	Acier inox	Camicia statore	Acciaio inox
9	Winding	Green wire	Bobinage	Green wire	Avvolgimento	Green wire
11	Lower bracket	Stainless steel	Support inférieur	Acier inox	Supporto inferiore	Acciaio inox
13	Mechanical seal	Silicon carbide/silicon carbide	Garniture mécanique	Carbure de silicium/ carbure de silicium	Tenuta meccanica	Carburo di silicio/ carburo di silicio
14 (15)	Bearing	Graphite	Coussinet	Graphite	Cuscinetto	Grafite
16	Thrust-bearing	Brass/Synthetic compound	Butée	Laiton/Composé synthétique	Reggispinta	Ottone/ Composito sintetico
17	Thrust-bearing foot slip	Cast iron	Support butée	Fonte grise	Supporto reggispinta	Ghisa grigia
18	Diaphragm	Rubber	Membrane	Caoutchouc	Membrana	Gomma
19	Diaphragm cover	Stainless steel	Couvercle de membrane	Acier inox	Coperchio membrana	Acciaio inox
20	Upper bracket	Stainless steel	Support supérieur	Acier inox	Supporto superiore	Acciaio inox

Bolts and nuts in stainless steel.

Visserie en acier inox

Bulloneria in acciaio inox

Motor construction and materials
 Construction du moteur et matériaux
 Costruzione motore e materiali

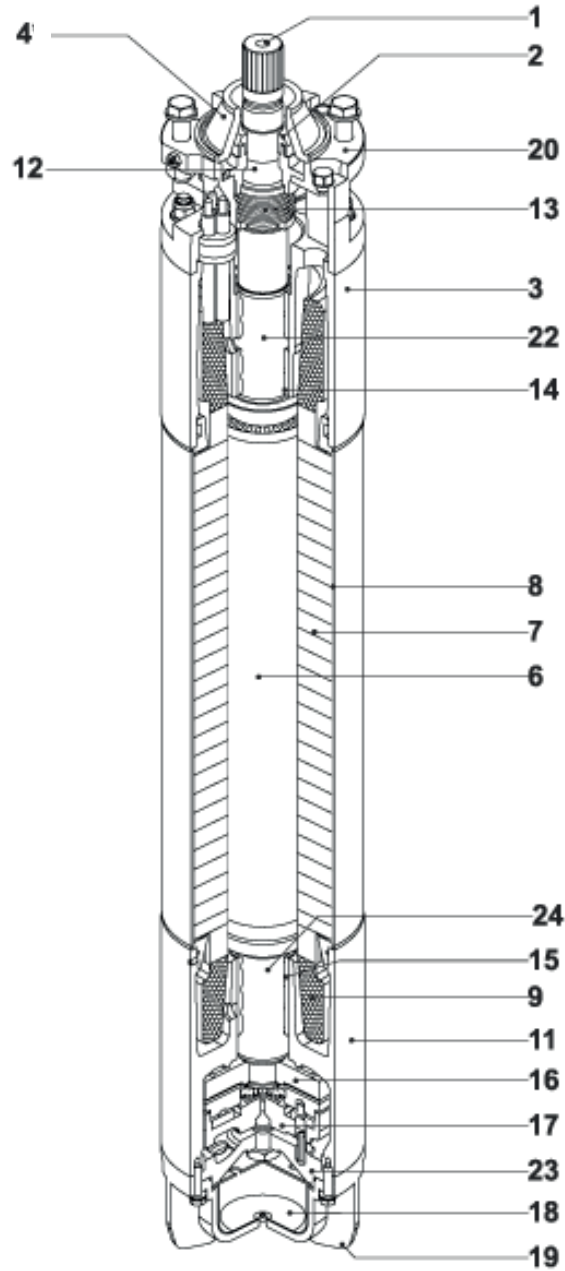

Pos.	Parts	Materials	Nomenclature	Matériaux	Nomenclatura	Materiale
1	Shaft	Stainless steel	Arbre	Acier inox	Albero	Acciaio inox
2	Sand guard	Rubber	para-sable	Caoutchouc	Parasabbia	Gomma
3	Upper bracket	Stainless steel	Support supérieur	Acier inox	Supporto superiore	Acciaio inox
4*	Protection	Rubber	Protecteur	Caoutchouc	Protettore	Gomma
6	Rotor	Electrical steel	Rotor	Tôle magnétique	Rotore	Lamierino magnetico
7	Stator	Electrical steel	Stator	Tôle magnétique	Statore	Lamierino magnetico
8	Stator shell	Stainless steel	Chemise de stator	Acier inox	Camicia statore	Acciaio inox
9	Winding	Green wire	Bobinage	Green wire	Avvolgimento	Green wire
11	Lower bracket	Stainless steel	Support inférieur	Acier inox	Supporto inferiore	Acciaio inox
12	Mechanical seal cover	Stainless steel	mécanique d'étanchéité	Acier inox	Coperchio tenuta meccanica	Acciaio inox
13	Mechanical seal (MACW)	Brass/Synthetic compound	Garniture mécanique	Laiton/Composé synthétique	Tenuta meccanica	Ottone/Composito sintetico
14 (15)	Bearing bush	Bronze	Coussinet	Bronze	Bronzina	Bronzo
14 (15)	Bearing bush (MACW8150)	Graphite	Coussinet (MACW8150)	Graphite	Bronzina (MACW8150)	Grafite
16	Thrust-bearing	Stainless steel/ Synthetic compound	Butée	Acier inox/Composé synthétique	Reggispinta	Acciaio inox/ Composito sintetico
17	Thrust-bearing foot slip	Cast iron	Support butée	Fonte grise	Supporto reggispinta	Ghisa grigia
18	Diaphragm	Rubber	Membrane	Caoutchouc	Membrana	Gomma
19	Diaphragm cover	Stainless steel	Couvercle de membrane	Acier inox	Coperchio membrana	Acciaio inox
20	Connecting flange	Stainless steel	Support intermédiaire	Acier inox	Elemento di raccordo	Acciaio inox
22 (24)	Shaft sleeve	Chrome plated steel	Chemise d'arbre	Acier cromé	Bussola	Acciaio cromato
23	Motor bracket	Cast iron	Support moteur	Fonte grise	Disco di guida	Ghisa grigia

Bolts and nuts in stainless steel.

Visserie en acier inox

Bulloneria in acciaio inox

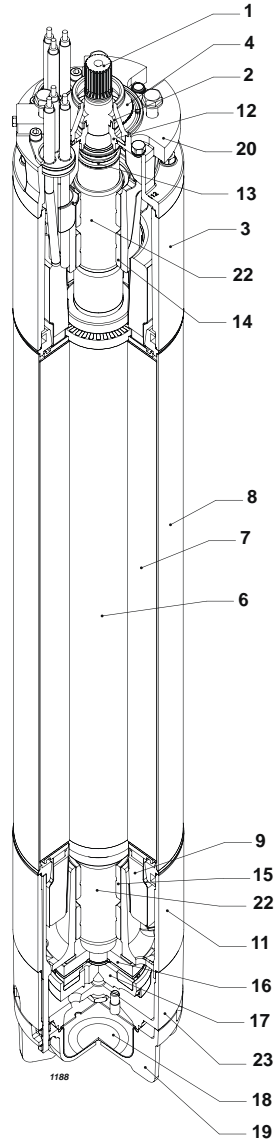

Pos.	Parts	Materials	Nomenclature	Matériaux	Nomenclatura	Materiale
1	Shaft	Stainless steel	Arbre	Acier inox	Albero	Acciaio inox
2	Sand guard	Rubber	para-sable	Caoutchouc	Parasabbia	Gomma
3	Upper cover	Stainless steel	Couvercle supérieur	Acier inox	Coperchio superiore	Acciaio inox
4	Protection	Rubber	Protecteur	Caoutchouc	Protettore	Gomma
6	Rotor	Electrical steel	Rotor	Tôle magnétique	Rotore	Lamierino magnetico
7	Stator	Electrical steel	Stator	Tôle magnétique	Statore	Lamierino magnetico
8	Stator shell	Stainless steel	Chemise de stator	Acier inox	Camicia statore	Acciaio inox
9	Winding	Green wire	Bobinage	Green wire	Avvolgimento	Green wire
11	Lower bracket	Stainless steel	Support inférieur	Acier inox	Supporto inferiore	Acciaio inox
12	Mechanical seal cover	Stainless steel	mécanique d'étanchéité	Acier inox	Coperchio tenuta meccanica	Acciaio inox
13	Mechanical seal	Silicon carbide/silicon carbide	Garniture mécanique	Carbure de silicium/ carbure de silicium	Tenuta meccanica	Carburo di silicio/ carburo di silicio
14 (15)	Bearing bush	Graphite	Coussinet	Graphite	Bronzina	Grafite
16	Thrust-bearing	Stainless steel/ Synthetic compound	Butée	Acier inox/Composé synthétique	Reggispinta	Acciaio inox/ Composito sintetico
17	Thrust-bearing foot slip	Cast iron	Support butée	Fonte grise	Supporto reggispinta	Ghisa grigia
18	Diaphragm	Rubber	Membrane	Caoutchouc	Membrana	Gomma
19	Diaphragm cover	Stainless steel	Couvercle de membrane	Acier inox	Coperchio membrana	Acciaio inox
20	Connecting flange	Stainless steel	Support intermédiaire	Acier inox	Elemento di raccordo	Acciaio inox
22	Shaft sleeve	Chrome plated steel	Chemise d'arbre	Acier chromé	Bussola	Acciaio cromato
23	Motor bracket	Stainless steel	Support moteur	Acier inox	Fondello motore	Acciaio inox

Bolts and nuts in stainless steel.
Cables outlet: see "Cables outlet"

Visserie en acier inox
Sortie câbles voir "Sortie câbles"

Bulloneria in acciaio inox
Uscita cavi: vedere "uscite cavi"

Motor construction and materials
 Construction du moteur et matériaux
 Costruzione motore e materiali

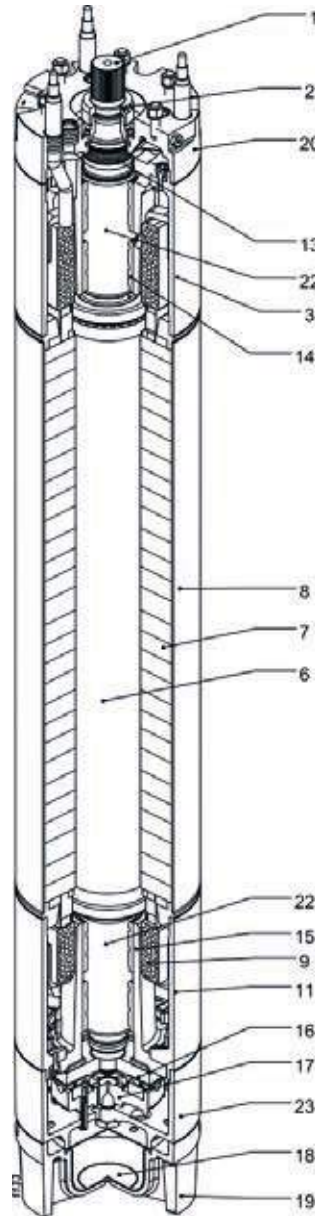

Pos.	Parts	Materials	Nomenclature	Matériaux	Nomenclatura	Materiale
1	Shaft	Stainless steel	Arbre	Acier inox	Albero	Acciaio inox
2	Sand guard	Stainless steel	para-sable	Acier inox	Parasabbia	Acciaio inox
3	Upper bracket	Stainless steel	Support supérieur	Acier inox	Supporto superiore	Acciaio inox
6	Rotor	Electrical steel	Rotor	Tôle magnétique	Rotore	Lamierino magnetico
7	Stator	Electrical steel	Stator	Tôle magnétique	Statore	Lamierino magnetico
8	Stator shell	Stainless steel	Chemise de stator	Acier inox	Camicia statore	Acciaio inox
9	Winding	Green wire	Bobinage	Green wire	Avvolgimento	Green wire
9	Winding (MACW12/C)	PE2+PA	Bobinage (MACW12/C)	PE2+PA	Avvolgimento (MACW12/C)	PE2+PA
11	Lower bracket	Stainless steel	Support inférieur	Acier inox	Supporto inferiore	Acciaio inox
13	Mechanical seal	Silicon carbide/silicon carbide	Garniture mécanique	Carbure de silicium/ carbure de silicium	Tenuta meccanica	Carburo di silicio/ carburo di silicio
14 (15)	Bearing	Graphite	Coussinet	Graphite	Cuscinetto	Grafite
16	Thrust-bearing	Stainless steel/ Synthetic compound	Butée	Acier inox/Composé synthétique	Reggispinta	Acciaio inox/ Composito sintetico
17	Thrust-bearing foot slip	Cast iron	Support butée	Fonte grise	Supporto reggispinta	Ghisa grigia
18	Diaphragm	Rubber	Membrane	Caoutchouc	Membrana	Gomma
19	Diaphragm cover	Stainless steel	Couvercle de membrane	Acier inox	Coperchio membrana	Acciaio inox
20	Connecting flange	Stainless steel	Support intermediaire	Acier inox	Elemento di raccordo	Acciaio inox
22	Shaft sleeve	Chrome plated steel	Chemise d'arbre	Acier cromé	Bussola	Acciaio cromato
23	Motor bracket	Stainless steel	Support moteur	Acier inox	Fondello motore	Acciaio inox

Bolts and nuts in stainless steel.
 Cables outlet: see "Cables outlet"

Visserie en acier inox
 Sortie câbles voir "Sortie câbles"

Bulloneria in acciaio inox
 Uscita cavi: vedere "uscita cavi"

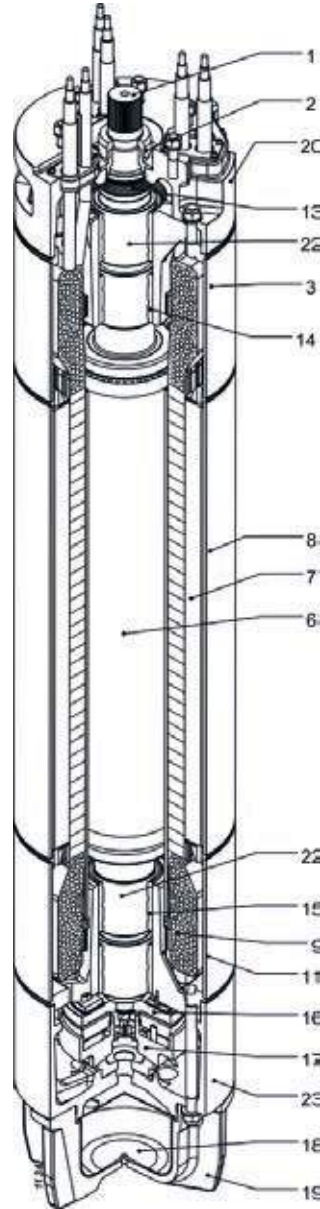

Pos.	Parts	Materials	Nomenclature	Matériaux	Nomenclatura	Materiale
1	Shaft	Stainless steel	Arbre	Acier inox	Albero	Acciaio inox
2	Sand guard	Stainless steel	para-sable	Acier inox	Parasabbia	Acciaio inox
3	Upper bracket	Stainless steel	Support supérieur	Acier inox	Supporto superiore	Acciaio inox
6	Rotor	Electrical steel	Rotor	Tôle magnétique	Rotore	Lamierino magnetico
7	Stator	Electrical steel	Stator	Tôle magnétique	Statore	Lamierino magnetico
8	Stator shell	Stainless steel	Chemise de stator	Acier inox	Camicia statore	Acciaio inox
9	Winding	PE2+PA	Bobinage	PE2+PA	Avvolgimento	PE2+PA
11	Lower bracket	Stainless steel	Support inférieur	Acier inox	Supporto inferiore	Acciaio inox
13	Mechanical seal	Silicon carbide/silicon carbide	Garniture mécanique	Carbure de silicium/ carbure de silicium	Tenuta meccanica	Carburo di silicio/ carburo di silicio
14 (15)	Bearing bush	Bronze	Coussinet	Bronze	Bronzina	Bronzo
14 (15)	Bearing bush (MW14540:600)	Graphite	Coussinet (MW14540:600)	Graphite	Bronzina (MW14540:600)	Grafite
16	Thrust-bearing	Brass/Synthetic compound	Butée	Laiton/Composé synthétique	Reggispinta	Ottone/Composito sintetico
17	Thrust-bearing foot slip	Nodular cast iron	Support butée	Fonte sphéroïdale	Supporto reggispinta	Ghisa sferoidale
18	Diaphragm	Rubber	Membrane	Caoutchouc	Membrana	Gomma
19	Diaphragm cover	Stainless steel	Couvercle de membrane	Acier inox	Coperchio membrana	Acciaio inox
20	Connecting flange	Stainless steel	Support intermédiaire	Acier inox	Elemento di raccordo	Acciaio inox
22	Shaft sleeve	Chrome plated steel	Chemise d'arbre	Acier cromé	Bussola	Acciaio cromato
23	Motor bracket	Stainless steel	Support moteur	Acier inox	Fondello motore	Acciaio inox

Bolts and nuts in stainless steel.
 Cables outlet: see "Cables outlet"

Visserie en acier inox
 Sortie câbles voir "Sortie câbles"

Bulloneria in acciaio inox
 Uscita cavi: vedere "uscita cavi"

General notes about the wet end
 Remarques générales partie hydraulique
 Note generali parte idraulica

- a) The submersible pumps ENDURANCE series are also suitable for lifting water that is chemically and mechanically aggressive.
- b) Maximum content of solids, the same hardness and granulometry of silt: 150 g/m³.
- c) Salinity degree: 40.000 ppm
- d) Maximum operating time when the outlet is closed and the pump is submersed: 3 min.
- e) Water pumping parameters were tested under the following conditions: motor power supply 400 V, cold water (15 °C) at atmospheric pressure (1 bar) guaranteed, since they are mass produced pumps, in compliance with: UNI/ISO 9906 Grade 3B.

The catalogue given data refer to liquids with a density of 1 kg/dm³ and kinematic viscosity of not more than 1 mm²/s, are comprehensive of friction losses in the check valves of radial pumps; in case of mixed-flow pumps, friction losses must, on the contrary, be deduced from the total head shown on the catalogue (see chart on page Friction losses).

- f) UPON REQUEST
 - Pumps can be tested according to UNI/ISO 9906 Grade 1B.
 - Pumps having characteristics differing from those shown in the catalogue can be supplied.
 - Special executions can be supplied with:
 - for horizontal installation, if not usually foreseen.

- a) *Les électropompes immergées de la série ENDURANCE ont été adaptées au soulèvement d'eau chimiquement et mécaniquement agressive.*
- b) *Contenu maximum des substances solides de la dureté et la granulométrie du limon: 150 g/m³.*
- c) *Degré de salinité: 40.000 ppm*
- d) *Temps maximum de fonctionnement, à vanne fermée et pompe submergée: 3 min.*
- e) *Les caractéristiques hydrauliques de fonctionnement ont été mesurées avec des moteurs alimentés à 400 V, avec de l'eau froide (15 °C) à la pression atmosphérique (1 bar) et sont garanties, s'agissant de pompes construites en série, suivant les normes:UNI/ISO 9906 Niveau 3B.*

Les données du catalogue se réfèrent à un liquide pompé de densité de 1 kg/dm³ et avec une viscosité cinématique non supérieure à 1 mm²/s. Elles comprennent les pertes de charge dans les clapets de retenue des pompes radiales. Pour les pompes semi-axiales, les pertes doivent être déduites de la hauteur manométrique totale indiquée dans le catalogue (voir diagramme page Pertes de charge).

- f) **SUR DEMANDE**
 - *Les pompes peuvent être testées selon les normes UNI/ISO 9906 Niveau 1B.*
 - *Nous pouvons fournir des électropompes de caractéristiques différentes de celles du catalogue.*
 - *Nous pouvons fournir des exécutions spéciales:*
 - *pour installation horizontale si pas normalement prévue.*

- a) **Le elettropompe sommersa serie ENDURANCE sono anche adatte al sollevamento di acqua chimicamente e meccanicamente aggressiva.**
- b) **Contenuto massimo di sostanze solide della durezza e granulometria del limo: 150 g/m³.**
- c) **Grado di salinità: 40.000 ppm**
- d) **Tempo massimo di funzionamento a bocca chiusa e pompa sommersa: 3 min.**
- e) **Le caratteristiche idrauliche di funzionamento sono state rilevate con motori alimentati a 400 V, con acqua fredda (15 °C) alla pressione atmosferica (1 bar) e vengono garantite, trattandosi di pompe costruite in serie, secondo le norme UNI/ISO 9906 Grado 3B.**

I dati di catalogo si riferiscono a liquidi con densità di 1 kg/dm³ e con viscosità cinematica non superiore a 1 mm²/s, e sono comprensivi delle perdite di carico nelle valvole di ritegno per le pompe radiali; per le pompe semiassiali, tali perdite devono essere invece detratte dalla prevalenza totale esposta in catalogo (vedi diagramma pagina Perdite di carico).

- f) **SU RICHIESTA**
 - **Possono essere collaudate secondo le norme UNI/ISO 9906 Grado 1B.**
 - **Possono essere fornite elettropompe con caratteristiche diverse da quelle a catalogo.**
 - **Possono essere fornite esecuzioni speciali:**
 - **per installazione in orizzontale, quando non già prevista.**

Motor general remarks
 Notes generales moteur
 Note generali motore

- a) Maximum submersion: 150 [m]
 Speed of the water outside the jacket of the motor higher:
 0,5 m/s for motors MACW...
- Max temperature liquid
 MACW6.. A = 40°C (5,5 - 20 cv)
 MACW6.. A = 35°C (25 - 40 cv)
 MACW6.. A = 30°C (50 cv)
 MACW6.. B = 45°C (5,5 - 20 cv)
 MACW6.. B = 40°C (25 - 40 cv)
 MACW6.. B = 35°C (50 - 60 cv)
 MACW8... = 30°C
 MACW10... = 25°C
 MACW12... = 25°C
 MW14... = 25°C
- b) STANDARD VERSION - THREE-PHASE/50 [Hz] supply voltage
 Direct starting:
 6": MACW...-8;
 400V for all power outputs
 8": MACW...-8;
 400V for all power outputs
 10": MACW...-8;
 400V for all power outputs
 12": MACW...-8;
 400V for all power outputs
 14": MW...-8;
 400V for all power outputs
- All the motors are fit for operation with an inverter, but in compliance with the following instructions:
 a filter is to be provided between the motor and the inverter to keep the voltage gradient (contact the sales network).
- c) VERSION ON REQUEST
 MACW6../3A - /3B - MACW8...
 standard motor with high efficiency (Motors used in the units specified in the catalogue)
- MACW6../3C
 Submersible motor specified for high temperature.
- For any further information please do not hesitate to contact our service network.
- THREE-PHASE/50 [Hz] supply voltage
 6": MACW...-6 230 V up to 30 kW,
 MACW...-7 230/400 V up to 45 kW
 (37 kW MACW6../3A)
 MACW...-8 400 V up to 45 kW,
 MACW...-9 400/700 V up to 45 kW
 (37 kW MACW6../3A)
 (9,2 - 45 kW MACW6../3C)
 8": MACW...-6 230 V up to 75 kW,
 MACW...-7 230/400 V up to 75 kW,
 MACW...-8 400 V up to 92 kW,
 MACW...-9 400/700 V up to 92 kW
 10": MACW...-6 230 V up to 75 kW,
 MACW...-7 230/400 V up to 75 kW,
 MACW...-8 400 V up to 185 kW,
 MACW...-9 400/700 V up to 185 kW
 12": MACW/1A...-8 400 V up to 190 kW,
 MACW/1A...-9 400 V up to 190 kW,
 MACW/1C...-8 400 V up to 250 kW,
 14": MW...-8 400 V up to 280 kW
- In addition, motors can be supplied:
 - for other voltages and frequencies
 - with special winding for hot water
- d) Permissible variations on the stated supply voltages without brackets:
 6"-14": (220 V), 230 V, (240 V) ± 10%
 6"-14": (380 V), 400 V, (415 V) ± 10%
 6"-14": for other voltages and frequencies ± 5%
- Tolerances on the operating data: according to the International Standards IEC 34-1.
 Thermal probes on request.
- a) *Immersion maximum : 150 [m]
 Vitesse de l'eau à l'extérieur de la chemise du moteur supérieure:
 0,5 m/s pour moteurs MACW...*
- Température Max liquide
 MACW6.. A = 40°C (5,5 - 20 cv)
 MACW6.. A = 35°C (25 - 40 cv)
 MACW6.. A = 30°C (50 cv)
 MACW6.. B = 45°C (5,5 - 20 cv)
 MACW6.. B = 40°C (25 - 40 cv)
 MACW6.. B = 35°C (50 - 60 cv)
 MACW8... = 30°C
 MACW10... = 25°C
 MACW12... = 25°C
 MW14... = 25°C*
- b) *EXECUTION STANDARD - Tension d'alimentation TRIPHASEE/50 [Hz]
 Démarrage direct :*
 6": MACW...-8;
 400V pour toutes les puissances
 8": MACW...-8;
 400V pour toutes les puissances
 10": MACW...-8;
 400V pour toutes les puissances
 12": MACW...-8;
 400V pour toutes les puissances
 14": MW...-8;
 400V pour toutes les puissances
- Tous les moteurs sont adaptés au fonctionnement à variateur de fréquence mais d'après les prescriptions suivantes:
 un filtre entre le moteur et le variateur de fréquence est à prévoir pour maintenir le gradient de tension (contacter le réseau de vente).*
- c) *EXECUTION SUR DEMANDE*
 MACW6../3A - /3B - MACW8...
 Moteur standard avec prestations élevées.
 (moteurs utilisés dans les groupes figurant sur le catalogue)
- MACW6../3C
 Moteur submersible spécifique pour utilisation à haute température.
- pour toute information complémentaire, n'hésitez pas à contacter notre réseau de vente.*
- Tension d'alimentation TRIPHASEE/50 [Hz]
 6": MACW...-6 230 V jusqu'à 30 kW,
 MACW...-7 230/400 V jusqu'à 45 kW
 (37 kW MACW6../3A)
 MACW...-8 400 V jusqu'à 45 kW,
 MACW...-9 400/700 V jusqu'à 45 kW
 (37 kW MACW6../3A)
 (9,2 - 45 kW MACW6../3C)
 8": MACW...-6 230 V jusqu'à 75 kW,
 MACW...-7 230/400 V jusqu'à 75 kW,
 MACW...-8 400 V jusqu'à 92 kW,
 MACW...-9 400/700 V jusqu'à 92 kW
 10": MACW...-6 230 V jusqu'à 75 kW,
 MACW...-7 230/400 V jusqu'à 75 kW,
 MACW...-8 400 V jusqu'à 185 kW,
 MACW...-9 400/700 V jusqu'à 185 kW
 12": MACW/1A...-8 400 V jusqu'à 190 kW,
 MACW/1A...-9 400 V jusqu'à 190 kW,
 MACW/1C...-8 400 V jusqu'à 250 kW,
 14": MW...-8 400 V jusqu'à 280 kW*
- En outre, des moteurs peuvent être fournis :
 - pour tensions et fréquences différentes
 - avec bobinage spécial pour eau chaude*
- d) *Variations admises sur les tensions d'alimentation indiquées sans parenthèses :*
 6"-14": (220 V), 230 V, (240 V) ± 10%
 6"-14": (380 V), 400 V, (415 V) ± 10%
 6"-14": pour tensions et fréquences différentes ± 5%
- Tolérances sur les caractéristiques de fonctionnement : selon les normes internationales IEC 34-1.*
- Sondes thermiques sur demande.*
- a) **Battente massimo: 150 [m]
 Velocità dell'acqua all'esterno della camicia del motore superiore:
 0,5 m/s per motori MACW...**
- Temperatura Max liquido
 MACW6.. A = 40°C (5,5 - 20 cv)
 MACW6.. A = 35°C (25 - 40 cv)
 MACW6.. A = 30°C (50 cv)
 MACW6.. B = 45°C (5,5 - 20 cv)
 MACW6.. B = 40°C (25 - 40 cv)
 MACW6.. B = 35°C (50 - 60 cv)
 MACW8... = 30°C
 MACW10... = 25°C
 MACW12... = 25°C
 MW14... = 25°C**
- b) **ESECUZIONE STANDARD - Tensione di alimentazione TRIFASE/50 [Hz]
 Avviamento diretto:**
 6": MACW...-8;
 400V per tutte le potenze
 8": MACW...-8;
 400V per tutte le potenze
 10": MACW...-8;
 400V per tutte le potenze
 12": MACW...-8;
 400V per tutte le potenze
 14": MW...-8;
 400V per tutte le potenze
- Tutti i motori sono idonei al funzionamento con inverter ma secondo le seguenti prescrizioni:
 tra inverter e motore aggiungere un filtro per attenuare il gradiente di tensione (contattare la rete di vendita)**
- c) **ESECUZIONI DISPONIBILI -**
 MACW6../3A - /3B - MACW8...
 Motore standard ad alte prestazioni.
 (motori impiegati nei gruppi a catalogo)
- MACW6../3C
 Motore sommerso per utilizzo ad alte temperature.
- Per ulteriori informazioni contattare la nostra rete di vendita
- Tensione di alimentazione TRIFASE/50 [Hz]
 6": MACW...-6 230 V fino a 30 kW,
 MACW...-7 230/400 V fino a 45 kW
 (37 kW MACW6../3A)
 MACW...-8 400 V fino a 45 kW,
 MACW...-9 400/700 V fino a 45 kW
 (37 kW MACW6../3A)
 (9,2 - 45 kW MACW6../3C)
 8": MACW...-6 230 V fino a 75 kW,
 MACW...-7 230/400 V fino a 75 kW,
 MACW...-8 400 V fino a 92 kW,
 MACW...-9 400/700 V fino a 92 kW
 10": MACW...-6 230 V fino a 75 kW,
 MACW...-7 230/400 V fino a 75 kW,
 MACW...-8 400 V fino a 185 kW,
 MACW...-9 400/700 V fino a 185 kW
 12": MACW/1A...-8 400 V fino a 190 kW,
 MACW/1A...-9 400 V fino a 190 kW,
 MACW/1C...-8 400 V fino a 250 kW,
 14": MW...-8 400 V fino a 280 kW**
- Possono inoltre essere forniti motori:
 - per tensioni e frequenze diverse
 - con avvolgimento speciale per acqua calda**
- d) **Variazioni ammesse sulle tensioni di alimentazione indicate senza parentesi:**
 6"÷14": (220 V), 230 V, (240 V) ± 10%
 6"÷14": (380 V), 400 V, (415 V) ± 10%
 6"÷14": per tensioni/frequenze diverse ± 5%
- Tolleranze sulle caratteristiche di funzionamento: secondo le Norme Internazionali IEC 34-1.**
- Sonde termiche su richiesta.**

Performance ranges
Champs de performances
Campi di prestazioni

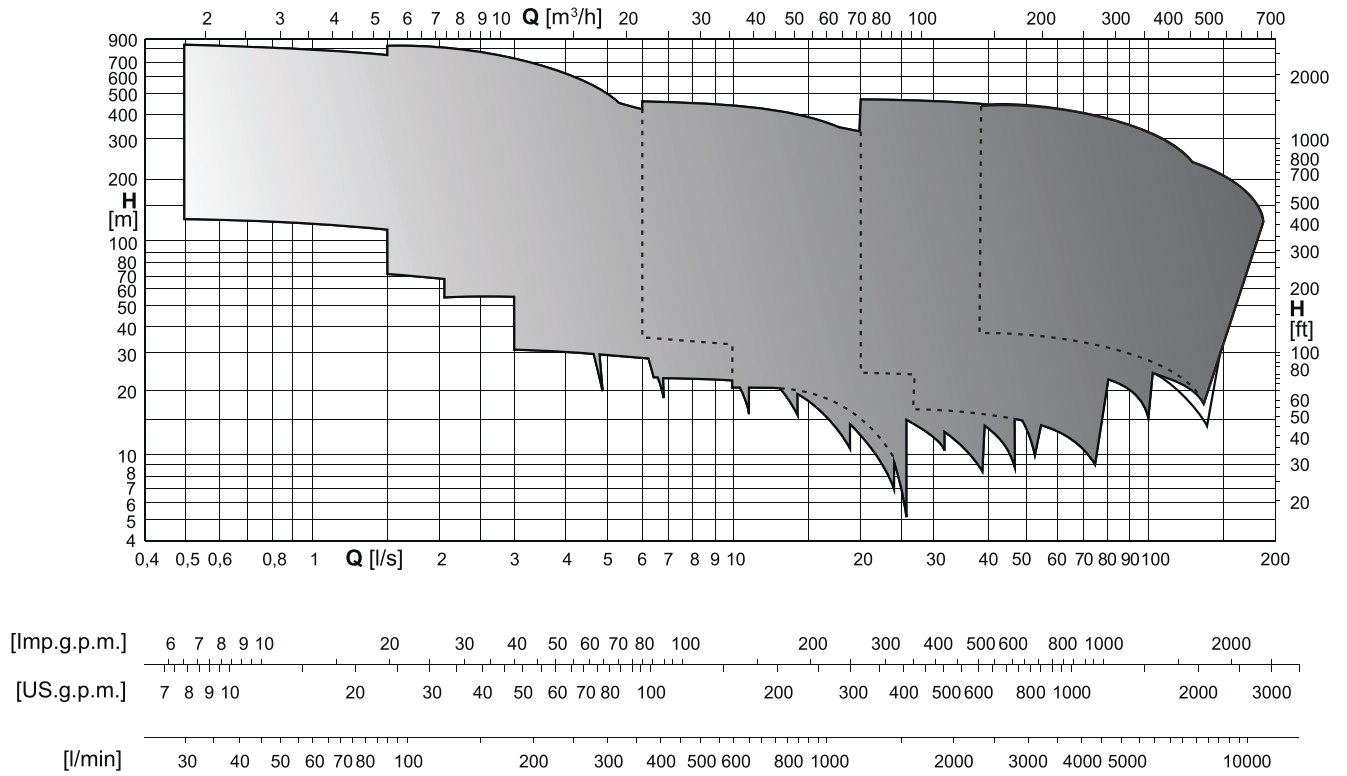

Operating data
Caractéristiques de fonctionnement
Caratteristiche di funzionamento

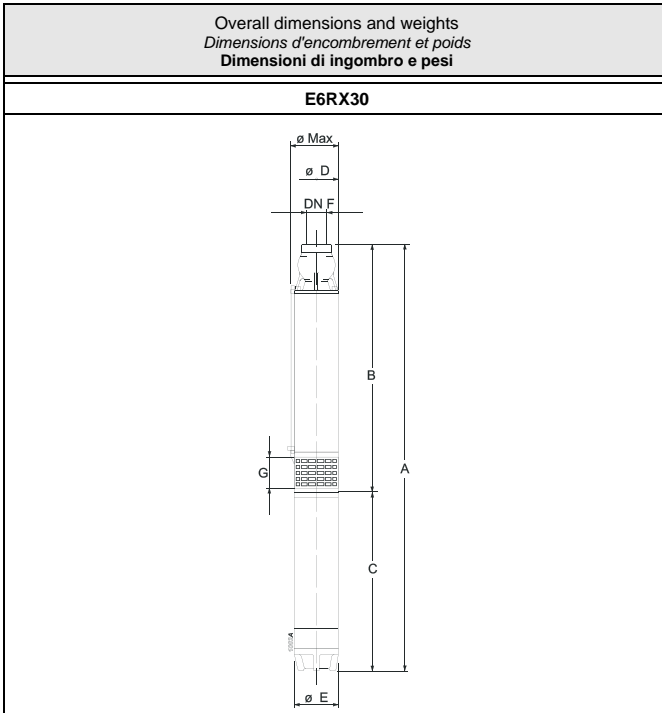

Type Type Tipo	ø max [mm]	Weight Poids Peso [kg]	A	B	C	D	E	F	G
			[mm]						
E6RX30/9A+MACW65A	148	61,4	1317	747	570	141	143	G2 1/2	100
E6RX30/13A+MACW67A	148	73,7	1542	927	615	141	143	G2 1/2	100
E6RX30/18A+MACW610A	148	87,7	1822	1152	670	141	143	G2 1/2	100
E6RX30/22A+MACW612A	148	98,4	2032	1332	700	141	143	G2 1/2	100
E6RX30/26A+MACW615A	148	110	2227	1512	715	141	143	G2 1/2	100
E6RX30/31A+MACW617A	148	123,2	2487	1737	750	141	143	G2 1/2	100
E6RX30/36A+MACW620A	148	136,2	2752	1962	790	141	143	G2 1/2	100
E6RX30/40A+MACW625A	148	148	2972	2142	830	141	143	G2 1/2	100
E6RX30/45A+MACW625A	148	157,2	3197	2367	830	141	143	G2 1/2	100
E6RX30/49A+MACW630A	148	174,9	3467	2547	920	141	143	G2 1/2	100
E6RX30/53A+MACW630A	148	182,2	3647	2727	920	141	143	G2 1/2	100
E6RX30/56A+MACW635A	148	202,5	3917	2862	1055	141	143	G2 1/2	100
E6RX30/60A+MACW635A	148	209,9	4097	3042	1055	141	143	G2 1/2	100

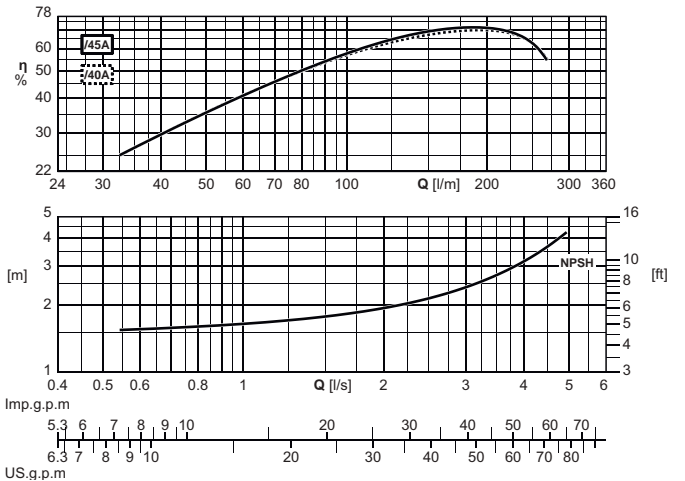
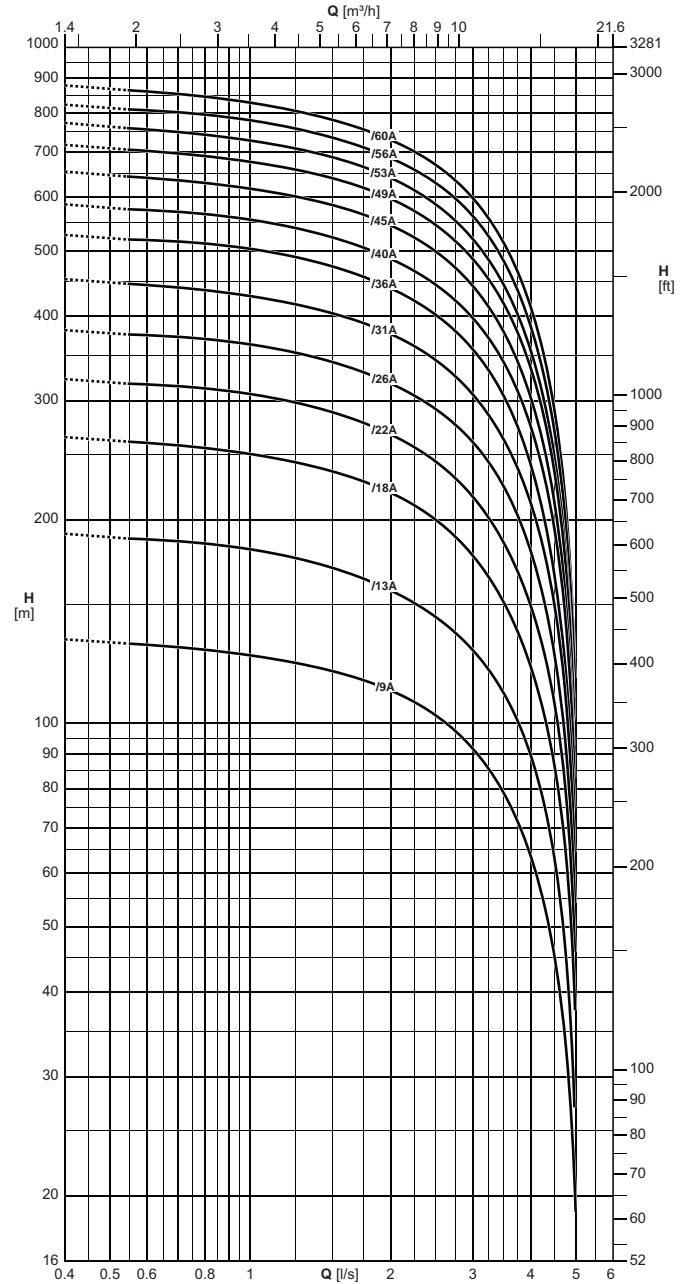

The hydraulic performance characteristics are guaranteed as conforming to standard UNI/ISO 9906 Grade 3B. Available with NPT thread.

Les caractéristiques hydrauliques de fonctionnement sont garanties conformes à la norme UNI/ISO 9906 Niveau 3B. Disponible avec filetage NPT.

Le caratteristiche di funzionamento vengono garantite secondo la norma: UNI/ISO 9906 Grado 3B. Disponibile con filettatura NPT.

Operating data
Caracteristiques de fonctionnement
Caratteristiche di funzionamento

Electric pump type Electropompe type Elettropompa tipo	Motor power Puis. moteur Potenza motore		Horizontal installation Installation horizontale Installazione orizzontale	Check valve \varnothing Clapet de retenue \varnothing Valvola di ritegno \varnothing	Capacity Debit Portata																		
	[kW]	[HP]			[l/s]	0	0,6	0,7	0,8	0,9	1	1,2	1,4	1,6	1,8	2	2,2	2,4	2,6	2,8	3	4	
					[l/min]	0	36	42	48	54	60	72	84	96	108	120	132	144	156	168	180	240	
					[m ³ /h]	0	2,2	2,5	2,9	3,2	3,6	4,3	5	5,8	6,5	7,2	7,9	8,6	9,4	10,1	10,8	14,4	
Head Hauteur Prevalenza																							
E6RX30/9A+MACW65A	4	5,5	■	2 1/2" Gas	[m]	133	130	129	128	127	126	123	121	118	114	111	109	104	101	97	91	64	
E6RX30/13A+MACW67A	5,5	7,5	■	2 1/2" Gas	[m]	191	187	186	185	183	180	176	172	167	162	157	153	146	139	135	129	88	
E6RX30/18A+MACW610A	7,5	10	■	2 1/2" Gas	[m]	265	259	258	256	253	250	243	239	233	225	218	213	204	194	186	177	118	
E6RX30/22A+MACW612A	9,2	12,5	■	2 1/2" Gas	[m]	323	316	315	313	310	307	298	292	285	275	267	260	248	236	228	217	146	
E6RX30/26A+MACW615A	11	15	■	2 1/2" Gas	[m]	382	374	373	371	367	363	354	347	338	327	317	309	297	283	274	261	175	
E6RX30/31A+MACW617A	13	17,5	■	2 1/2" Gas	[m]	454	444	441	438	433	428	417	409	399	387	375	366	351	335	323	308	208	
E6RX30/36A+MACW620A	15	20	■	2 1/2" Gas	[m]	528	518	515	513	508	503	490	480	468	452	439	428	410	391	377	359	236	
E6RX30/40A+MACW625A	18,5	25	■	2 1/2" Gas	[m]	586	573	570	568	562	555	541	530	517	500	485	473	454	433	418	399	270	
E6RX30/45A+MACW625A	18,5	25	■	2 1/2" Gas	[m]	655	640	636	632	624	617	603	592	578	560	544	531	509	486	469	447	300	
E6RX30/49A+MACW630A	22	30	■	2 1/2" Gas	[m]	717	701	697	692	684	676	660	648	633	613	596	581	557	531	513	489	330	
E6RX30/53A+MACW630A	22	30	○	2 1/2" Gas	[m]	773	755	749	744	736	728	710	697	680	659	640	624	598	570	550	524	353	
E6RX30/56A+MACW635A	26	35	○	2 1/2" Gas	[m]	823	805	801	797	788	779	759	745	726	704	684	667	641	612	592	564	378	
E6RX30/60A+MACW635A	26	35	○	2 1/2" Gas	[m]	879	859	853	847	837	827	806	791	772	748	728	710	682	652	630	601	406	
NPSH					[m]	-	1,6	1,6	1,6	1,6	1,7	1,7	1,8	1,8	1,9	2	2,1	2,2	2,3	2,4	2,5	3,3	

M.E.I. $\geq 0,40$

■ Without conical valve

□ On request

○ Please contact our sales organisation

For motor performances specification see page "motor features"

Temperature monitoring device for submersed electric motors 6" ÷ 14": see page "Accessories"

■ Sans soupape du clapet.

□ Sur demande

○ Contacter notre service commercial.

Pour caractéristiques techniques moteurs voir page "Caractéristiques des moteurs"

Appareillage de contrôle de la température des moteurs électriques immergés 6" ÷ 14": voir page "Accessories"

■ Senza clapet valvola di ritegno

□ Su richiesta

○ Interpellare la sede o la rete di vendita

Per caratteristiche motori vedere pagina "caratteristiche motori"

Apparecchiatura di controllo temperatura motori elettrici sommersi 6" ÷ 14": vedere pagina accessori

Operating data
Caracteristiques de fonctionnement
Caratteristiche di funzionamento

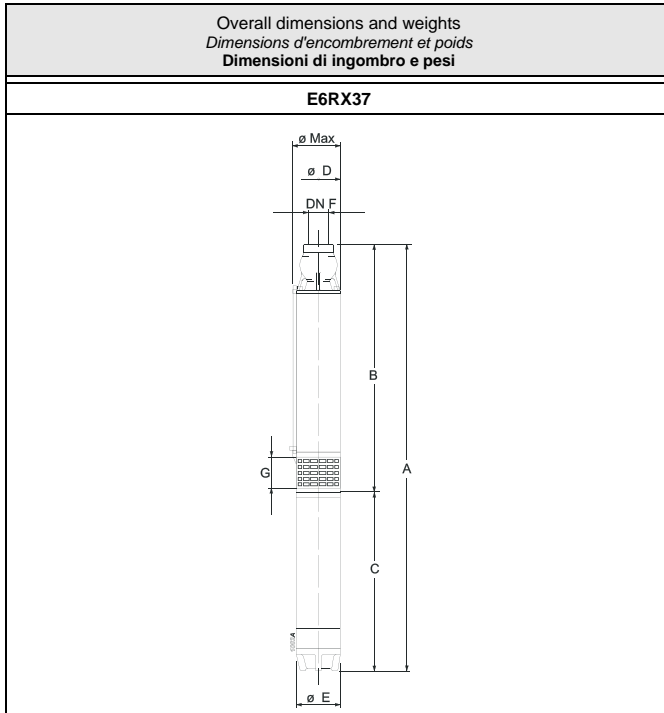

Type Type Tipo	ø max [mm]	Weight Poids Peso [kg]	A	B	C	D	E	F	G
			[mm]						
E6RX37/77A+MACW65A	148	57,1	1227	657	570	141	143	G2 1/2	100
E6RX37/9A+MACW67A	148	65,7	1362	747	615	141	143	G2 1/2	100
E6RX37/11A+MACW610A	148	74	1507	837	670	141	143	G2 1/2	100
E6RX37/13A+MACW610A	148	77,6	1597	927	670	141	143	G2 1/2	100
E6RX37/16A+MACW612A	148	86,2	1762	1062	700	141	143	G2 1/2	100
E6RX37/19A+MACW615A	148	95,8	1912	1197	715	141	143	G2 1/2	100
E6RX37/22A+MACW617A	148	105,1	2082	1332	750	141	143	G2 1/2	100
E6RX37/26A+MACW620A	148	116	2302	1512	790	141	143	G2 1/2	100
E6RX37/29A+MACW625A	148	125,7	2477	1647	830	141	143	G2 1/2	100
E6RX37/32A+MACW625A	148	131	2612	1782	830	141	143	G2 1/2	100
E6RX37/35A+MACW630A	148	146,6	2837	1917	920	141	143	G2 1/2	100
E6RX37/38A+MACW630A	148	151,9	2972	2052	920	141	143	G2 1/2	100
E6RX37/41A+MACW635A	148	172	3242	2187	1055	141	143	G2 1/2	100
E6RX37/45A+MACW635A	148	179,1	3422	2367	1055	141	143	G2 1/2	100
E6RX37/48A+MACW640A	148	197	3667	2502	1165	141	143	G2 1/2	100
E6RX37/52A+MACW640A	148	204,1	3847	2682	1165	141	143	G2 1/2	100
E6RX37/56A+MACW650B	148	228,3	4144	2862	1282	141	143	G2 1/2	100
E6RX37/60A+MACW650B	148	235,4	4324	3042	1282	141	143	G2 1/2	100

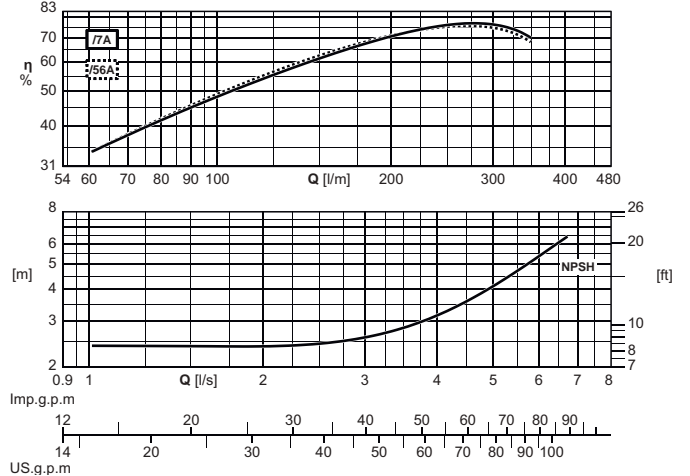
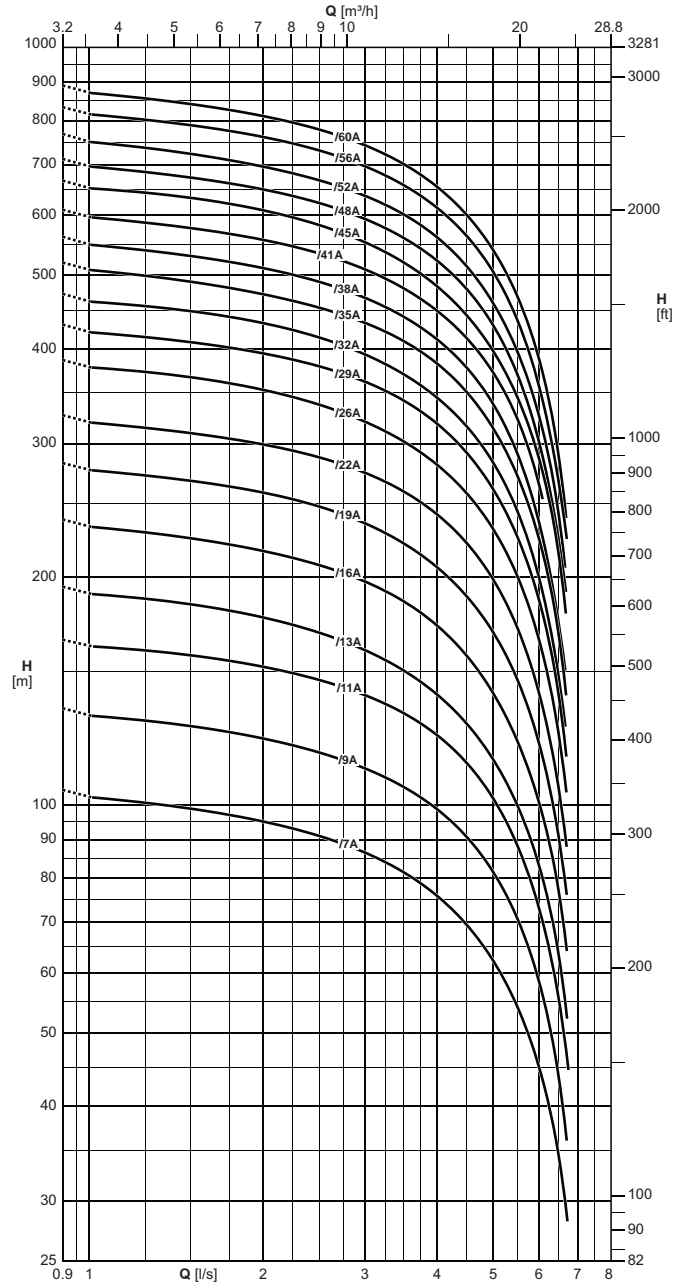

The hydraulic performance characteristics are guaranteed as conforming to standard UNI/ISO 9906 Grade 3B. Available with NPT thread.

Les caractéristiques hydrauliques de fonctionnement sont garanties conformes à la norme UNI/ISO 9906 Niveau 3B. Disponible avec filettatura NPT.

Le caratteristiche di funzionamento vengono garantite secondo la norma: UNI/ISO 9906 Grado 3B. Disponibile con filettatura NPT.

Operating data
Caracteristiques de fonctionnement
Caratteristiche di funzionamento

Electric pump type Electropompe type Elettropompa tipo	Motor power Puis. moteur Potenza motore		Horizontal installation Installation horizontale Installazione orizzontale	Check valve Ø Clapet de retenue Ø Valvola di ritegno Ø	Capacity Debit Portata															
	[kW]	[HP]			[l/s]	0	1	1,2	1,4	1,6	1,8	2	2,2	2,4	2,6	2,8	3	4	5	6
					[l/min]	0	60	72	84	96	108	120	132	144	156	168	180	240	300	360
					[m³/h]	0	3,6	4,3	5	5,8	6,5	7,2	7,9	8,6	9,4	10,1	10,8	14,4	18	21,6
Head Hauteur Prevalenza																				
E6RX37/7A+MACW65A	4	5,5	■	2½" Gas	[m]	105	102	101	99	98	96	95	93	92	90	88	86	75	62	44,5
E6RX37/9A+MACW67A	5,5	7,5	■	2½" Gas	[m]	134	131	129	128	126	124	122	120	118	116	114	112	98	81	58
E6RX37/11A+MACW610A	7,5	10	■	2½" Gas	[m]	165	162	160	158	156	154	152	149	147	144	142	139	123	101	71
E6RX37/13A+MACW610A	7,5	10	■	2½" Gas	[m]	194	190	187	185	182	179	176	173	170	167	163	160	139	114	83
E6RX37/16A+MACW612A	9,2	12,5	■	2½" Gas	[m]	238	233	229	226	223	220	216	213	209	205	201	197	172	140	100
E6RX37/19A+MACW615A	11	15	■	2½" Gas	[m]	283	277	273	269	266	262	258	254	250	245	240	235	206	169	120
E6RX37/22A+MACW617A	13	17,5	■	2½" Gas	[m]	327	320	315	311	307	303	299	295	290	285	280	274	241	198	140
E6RX37/26A+MACW620A	15	20	■	2½" Gas	[m]	387	378	374	369	364	359	353	347	341	334	327	320	281	231	165
E6RX37/29A+MACW625A	18,5	25	■	2½" Gas	[m]	431	420	416	410	405	400	394	388	382	376	369	362	319	261	187
E6RX37/32A+MACW625A	18,5	25	■	2½" Gas	[m]	473	462	457	451	445	439	432	426	418	410	402	394	345	284	202
E6RX37/35A+MACW630A	22	30	■	2½" Gas	[m]	520	508	501	494	487	479	472	465	457	449	441	433	383	315	225
E6RX37/38A+MACW630A	22	30	■	2½" Gas	[m]	562	549	541	534	527	519	511	503	495	486	477	467	413	340	239
E6RX37/41A+MACW635A	26	35	■	2½" Gas	[m]	610	596	589	581	572	565	557	548	538	529	520	508	452	370	265
E6RX37/45A+MACW635A	26	35	■	2½" Gas	[m]	667	651	644	637	628	619	609	599	588	577	565	553	484	398	289
E6RX37/48A+MACW640A	30	40	○	2½" Gas	[m]	712	696	687	677	668	659	649	639	628	617	606	594	523	430	303
E6RX37/52A+MACW640A	30	40	○	2½" Gas	[m]	769	750	740	729	718	707	696	685	674	662	650	637	563	462	331
E6RX37/56A+MACW650B	37	50	○	2½" Gas	[m]	834	816	805	794	783	772	761	749	737	724	710	696	613	504	356
E6RX37/60A+MACW650B	37	50	○	2½" Gas	[m]	891	871	859	847	835	823	811	799	786	772	758	742	655	541	389
NPSH					[m]	-	2,6	2,6	2,5	2,5	2,4	2,4	2,3	2,3	2,4	2,4	2,5	3,1	4,2	5,5

M.E.I. ≥ 0,40

■ Without conical valve

□ On request

○ Please contact our sales organisation

For motor performances specification see page "motor features"

Temperature monitoring device for submersed electric motors 6" ÷ 14": see page "Accessories"

■ Sans soupape du clapet.

□ Sur demande

○ Contacter notre service commercial.

Pour caractéristiques techniques moteurs voir page "Caractéristiques des moteurs"

Appareillage de contrôle de la température des moteurs électriques immergés 6" ÷ 14": voir page "Accessories"

■ Senza clapet valvola di ritegno

□ Su richiesta

○ Interpellare la sede o la rete di vendita

Per caratteristiche motori vedere pagina "caratteristiche motori"

Apparecchiatura di controllo temperatura motori elettrici sommersi 6" ÷ 14": vedere pagina accessori

Operating data
Caracteristiques de fonctionnement
Caratteristiche di funzionamento

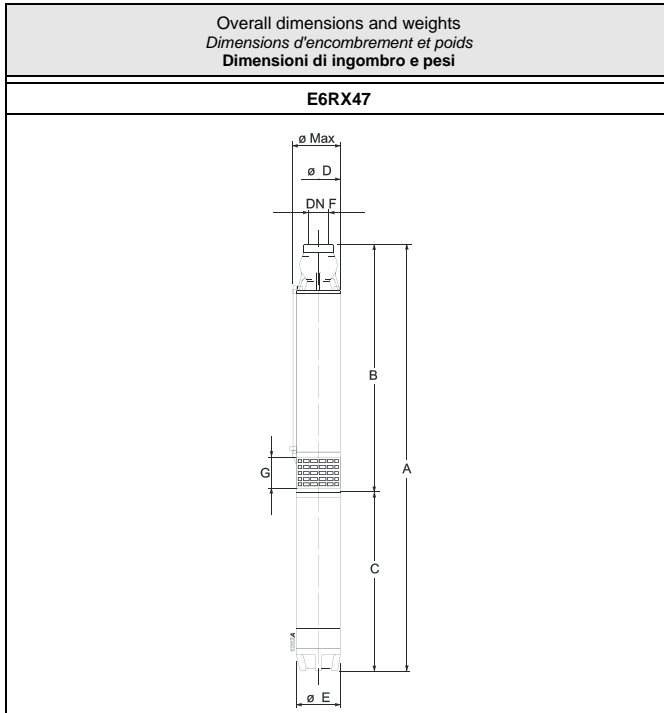

Type Type Tipo	ø max	Weight Poids Peso	A	B	C	D	E	F	G
	[mm]								
E6RX47/4I+MACW65A	148	51,9	1157	587	570	141	143	G3	100
E6RX47/5A+MACW67A	148	59,1	1259	644	615	141	143	G3	100
E6RX47/7A+MACW610A	148	68,3	1428	758	670	141	143	G3	100
E6RX47/9I+MACW612A	148	76	1572	872	700	141	143	G3	100
E6RX47/10A+MACW615A	148	82,5	1644	929	715	141	143	G3	100
E6RX47/12A+MACW617A	148	90,9	1793	1043	750	141	143	G3	100
E6RX47/14A+MACW620A	148	99,1	1947	1157	790	141	143	G3	100
E6RX47/17A+MACW625A	148	110,1	2158	1328	830	141	143	G3	100
E6RX47/21A+MACW630A	148	129,2	2476	1556	920	141	143	G3	100
E6RX47/25A+MACW635A	148	152,8	2839	1784	1055	141	143	G3	100
E6RX47/28A+MACW640A	148	172	3120	1955	1165	141	143	G3	100
E6RX47/31A+MACW650B	148	195,7	3408	2126	1282	141	143	G3	100
E6RX47/35A+MACW650B	148	204,5	3636	2354	1282	141	143	G3	100

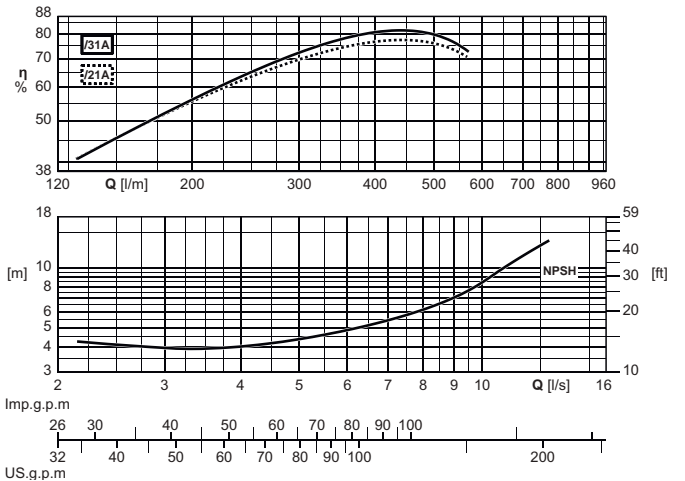
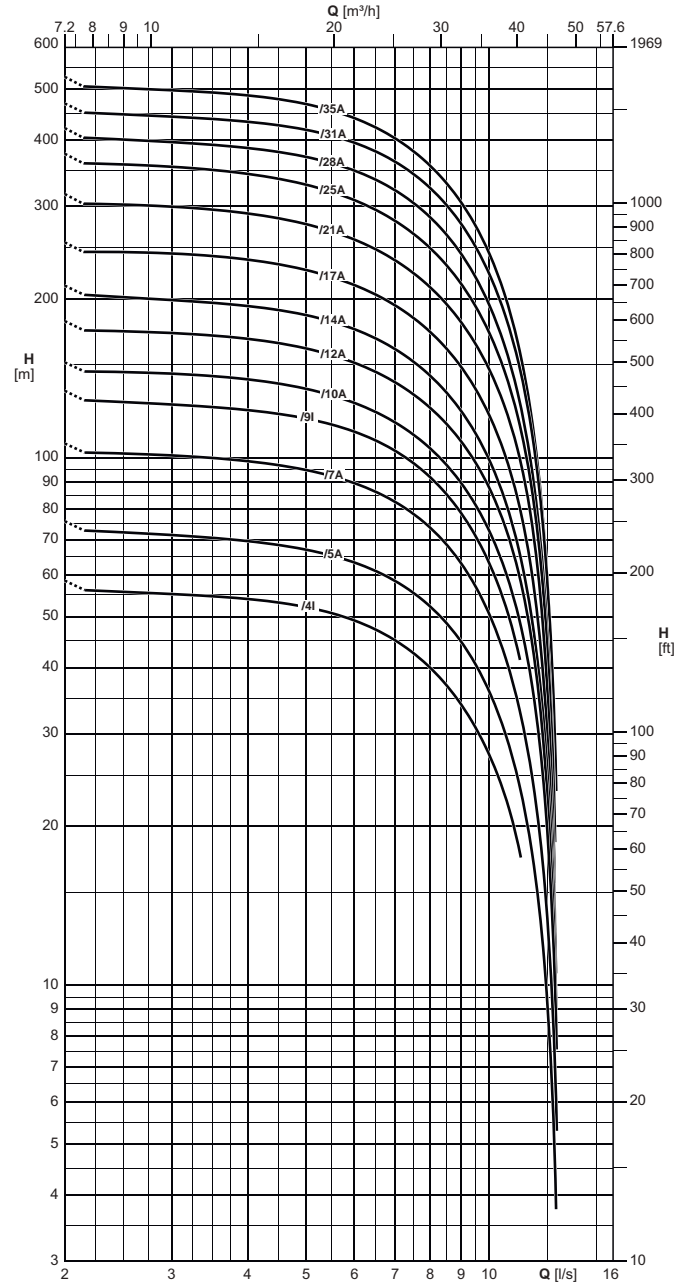

The hydraulic performance characteristics are guaranteed as conforming to standard UNI/ISO 9906 Grade 3B.
Available with NPT thread.

Les caractéristiques hydrauliques de fonctionnement sont garanties conformes à la norme UNI/ISO 9906 Niveau 3B.
Disponible avec filetture NPT.

Le caratteristiche di funzionamento vengono garantite secondo la norma: UNI/ISO 9906 Grado 3B.
Disponibile con filettatura NPT.

Operating data
Caracteristiques de fonctionnement
Caratteristiche di funzionamento

Electric pump type Electropompe type Elettropompa tipo	Motor power Puis. moteur Potenza motore		Horizontal installation Installation horizontale Installazione orizzontale	Check valve \varnothing Clapet de retenue \varnothing Valvola di ritegno \varnothing	Capacity Debit Portata																		
					[l/s]	0	3	3,5	4	4,5	5	5,5	6	6,5	7	7,5	8	8,5	9	9,5	10	11	12
	[l/min]	0			180	210	240	270	300	330	360	390	420	450	480	510	540	570	600	660	720		
	[m ³ /h]	0			10,8	12,6	14,4	16,2	18	19,8	21,6	23,4	25,2	27	28,8	30,6	32,4	34,2	36	39,6	43,2		
[kW]	[HP]	Head Hauteur Prevalenza																					
E6RX47/4+MACW65A	4	5,5	■	3" Gas	[m]	58	55	55	54	53	52	51	49	47,5	45,5	42,5	40	37	34	31	27	20	-
E6RX47/5A+MACW67A	5,5	7,5	■	3" Gas	[m]	76	71	70	69	68	67	65	63	61	58	55	52	48,5	44,5	40,5	36,5	26	15
E6RX47/7A+MACW610A	7,5	10	■	3" Gas	[m]	106	101	100	98	97	95	92	89	86	82	78	73	69	63	57	51	36,5	21,5
E6RX47/9I+MACW612A	9,2	12,5	■	3" Gas	[m]	134	126	125	123	121	118	116	112	108	103	97	92	85	78	71	63	46	-
E6RX47/10A+MACW615A	11	15	■	3" Gas	[m]	152	144	143	141	138	135	132	127	122	117	111	104	97	90	81	73	54	32
E6RX47/12A+MACW617A	13	17,5	■	3" Gas	[m]	181	172	170	168	165	161	156	151	145	139	131	124	116	107	98	88	65	37,5
E6RX47/14A+MACW620A	15	20	■	3" Gas	[m]	212	199	196	194	190	186	181	175	168	160	152	143	133	122	111	100	72	42
E6RX47/17A+MACW625A	18,5	25	■	3" Gas	[m]	256	244	241	237	233	227	220	212	204	195	184	173	160	148	136	120	89	50
E6RX47/21A+MACW630A	22	30	■	3" Gas	[m]	316	299	295	290	285	278	269	259	248	236	224	211	195	180	163	147	108	63
E6RX47/25A+MACW635A	26	35	■	3" Gas	[m]	377	356	351	345	338	330	319	308	296	281	266	249	231	213	195	171	128	72
E6RX47/28A+MACW640A	30	40	○	3" Gas	[m]	422	397	392	386	380	373	362	351	336	321	305	286	264	244	222	194	139	80
E6RX47/31A+MACW650B	37	50	○	3" Gas	[m]	470	443	439	433	427	419	407	395	381	363	344	324	302	275	251	225	162	94
E6RX47/35A+MACW650B	37	50	○	3" Gas	[m]	527	498	493	486	479	469	455	441	422	402	382	358	331	305	278	243	173	99
NPSH					[m]	-	3,9	3,9	4	4,2	4,5	4,6	4,8	5,1	5,5	5,8	6,2	6,6	6,9	7,7	8,3	10	12

M.E.I. $\geq 0,40$

■ Without conical valve

□ On request

○ Please contact our sales organisation

For motor performances specification see page "motor features"

Temperature monitoring device for submersed electric motors 6" ÷ 14": see page "Accessories"

■ Sans soupape du clapet.

□ Sur demande

○ Contacter notre service commercial.

Pour caractéristiques techniques moteurs voir page "Caractéristiques des moteurs"

Appareillage de contrôle de la température des moteurs électriques immergés 6" ÷ 14": voir page "Accessories"

■ Senza clapet valvola di ritegno

□ Su richiesta

○ Interpellare la sede o la rete di vendita

Per caratteristiche motori vedere pagina "caratteristiche motori"

Apparecchiatura di controllo temperatura motori elettrici sommersi 6" ÷ 14": vedere pagina accessori

Operating data
Caracteristiques de fonctionnement
Caratteristiche di funzionamento

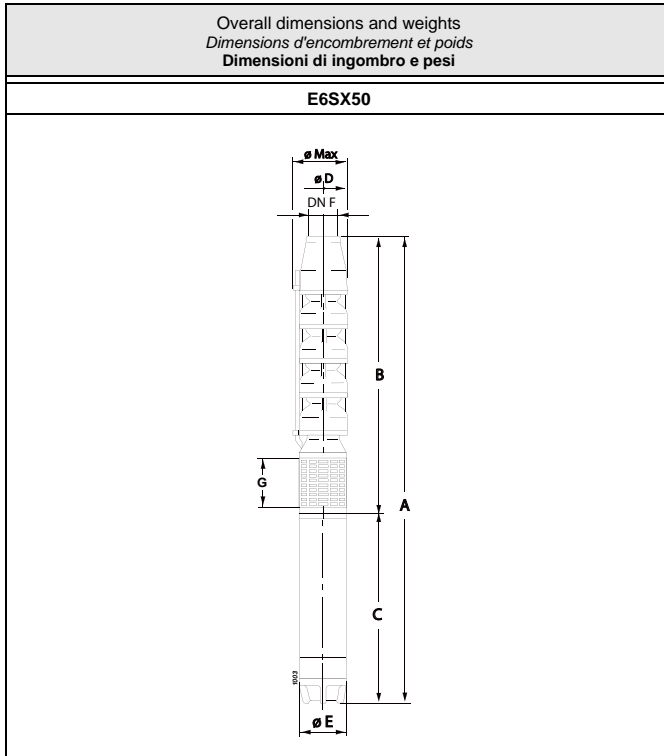

Type Type Tipo	Ø max	Weight Poids Peso	A	B	C	D	E	F	G
E6SX50/3A+MACW65A	150	60	1297	727	570	141	143	G3	124
E6SX50/4A+MACW67A	150	69,5	1457	842	615	141	143	G3	124
E6SX50/6M+MACW610A	150	88,5	1742	1072	670	141	143	G3	124
E6SX50/7I+MACW612A	150	96	1887	1187	700	141	143	G3	124
E6SX50/8A+MACW615A	150	106	2017	1302	715	141	143	G3	124
E6SX50/9A+MACW617A	150	114,5	2167	1417	750	141	143	G3	124
E6SX50/11A+MACW620A	150	129	2437	1647	790	141	143	G3	124
E6SX50/14A+MACW625A	150	145	2822	1992	830	141	143	G3	124
E6SX50/16A+MACW630A	150	164,5	3142	2222	920	141	143	G3	124
E6SX50/19A+MACW635A	150	196,5	3622	2567	1055	141	143	G3	124
E6SX50/22A+MACW640A	150	226	4077	2912	1165	141	143	G3	124
E6SX50/28A+MACW650B	150	271,5	4884	3602	1282	141	143	G3	124

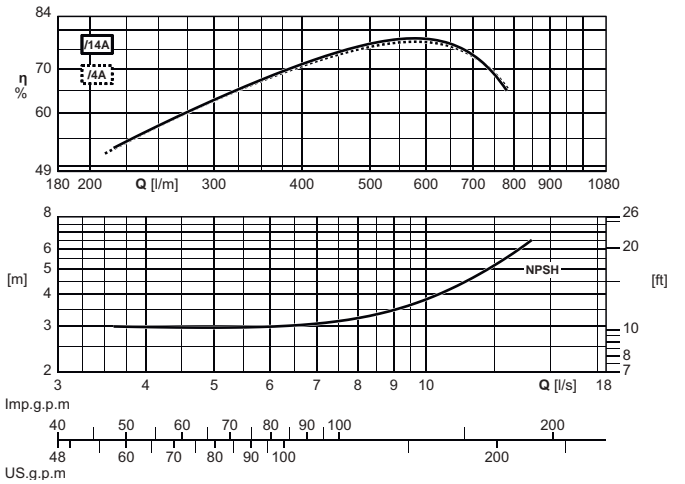
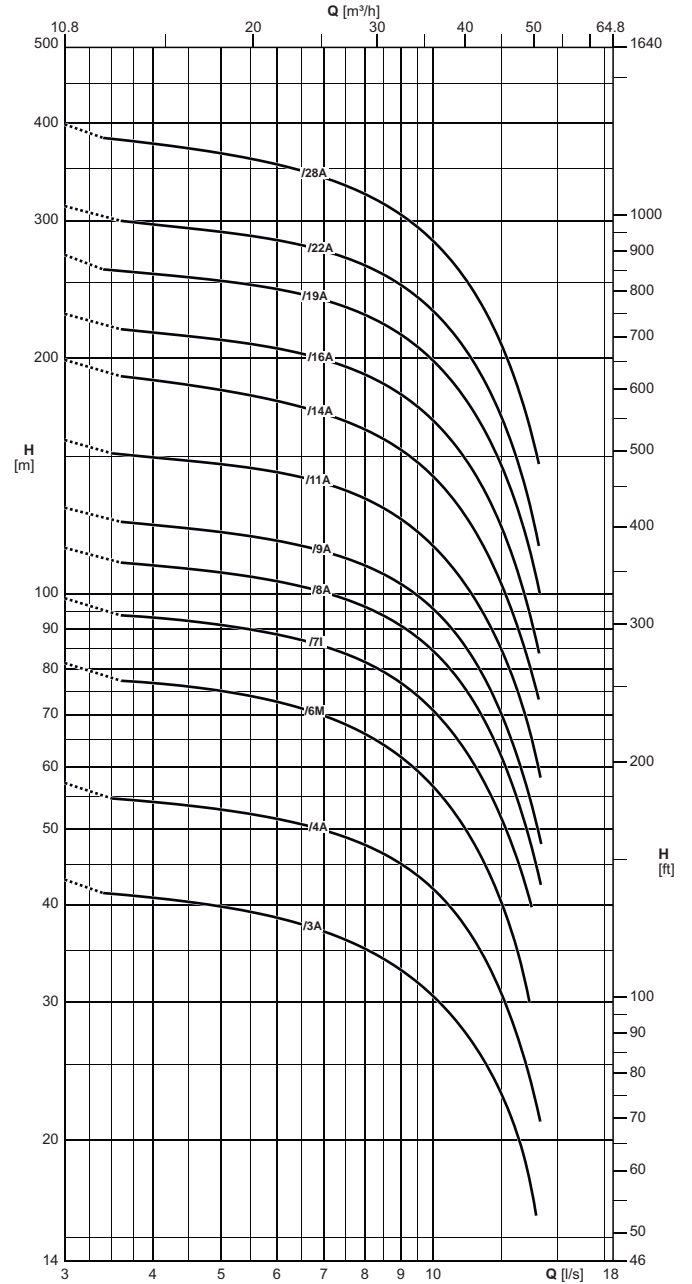

The hydraulic performance characteristics are guaranteed as conforming to standard UNI/ISO 9906 Grade 3B. Available with NPT thread.

Les caractéristiques hydrauliques de fonctionnement sont garanties conformes à la norme UNI/ISO 9906 Niveau 3B. Disponible avec filetage NPT.

Le caratteristiche di funzionamento vengono garantite secondo la norma: UNI/ISO 9906 Grado 3B. Disponibile con filettatura NPT.

Operating data
 Caracteristiques de fonctionnement
 Caratteristiche di funzionamento

Electric pump type Electropompe type Elettropompa tipo	Motor power Puis. moteur Potenza motore		Horizontal installation Installation horizontale Installazione orizzontale	Check valve \varnothing Clapet de retenue \varnothing Valvola di ritegno \varnothing	Capacity Debit Portata												
					[l/s]	0	4	5	6	7	8	9	10	11	12	13	14
	[l/min]	0			240	300	360	420	480	540	600	660	720	780	840		
	[m ³ /h]	0			14,4	18	21,6	25,2	28,8	32,4	36	39,6	43,2	46,8	50,4		
[kW]	[HP]	Head Hauteur Prevalenza															
E6SX50/3A+MACW65A	4	5,5	■	3" Gas	[m]	43	41	40	38,5	37	35	33	30,5	28	24,5	21	16
E6SX50/4A+MACW67A	5,5	7,5	■	3" Gas	[m]	57	54	53	51	50	47,5	45	42	38	33	28	22,5
E6SX50/6M+MACW610A	7,5	10	■	3" Gas	[m]	81	77	75	73	70	66	62	57	50	44	36,5	-
E6SX50/7I+MACW612A	9,2	12,5	■	3" Gas	[m]	99	93	91	88	85	82	77	70	64	56	47	-
E6SX50/8A+MACW615A	11	15	■	3" Gas	[m]	114	109	106	103	100	96	91	84	77	67	56	45
E6SX50/9A+MACW617A	13	17,5	■	3" Gas	[m]	129	122	120	117	113	109	103	96	87	76	64	51
E6SX50/11A+MACW620A	15	20	■	3" Gas	[m]	157	149	146	143	138	132	124	115	104	91	78	61
E6SX50/14A+MACW625A	18,5	25	■	3" Gas	[m]	199	188	182	176	170	162	152	141	127	111	93	75
E6SX50/16A+MACW630A	22	30	○	3" Gas	[m]	228	216	211	206	199	190	179	167	150	132	110	86
E6SX50/19A+MACW635A	26	35	○	3" Gas	[m]	271	257	251	245	237	227	215	198	180	158	132	105
E6SX50/22A+MACW640A	30	40	○	3" Gas	[m]	313	297	290	283	274	263	248	229	208	182	153	119
E6SX50/28A+MACW650B	37	50	○	3" Gas	[m]	399	377	366	354	341	324	304	283	255	226	190	151
NPSH					[m]	-	3	3	3	3	3,2	3,4	3,7	4,2	4,7	5,4	6,5

M.E.I. $\geq 0,40$

■ Without conical valve

□ On request

○ Please contact our sales organisation

For motor performances specification see page "motor features"

Temperature monitoring device for submersed electric motors 6" ÷ 14": see page "Accessories"

■ Sans soupape du clapet.

□ Sur demande

○ Contacter notre service commercial.

Pour caractéristiques techniques moteurs voir page "Caractéristiques des moteurs"

Appareillage de contrôle de la température des moteurs électriques immergés 6" ÷ 14": voir page "Accessories"

■ Senza clapet valvola di ritegno

□ Su richiesta

○ Interpellare la sede o la rete di vendita

Per caratteristiche motori vedere pagina "caratteristiche motori"

Apparecchiatura di controllo temperatura motori elettrici sommersi 6" ÷ 14": vedere pagina accessori

Operating data
Caracteristiques de fonctionnement
Caratteristiche di funzionamento

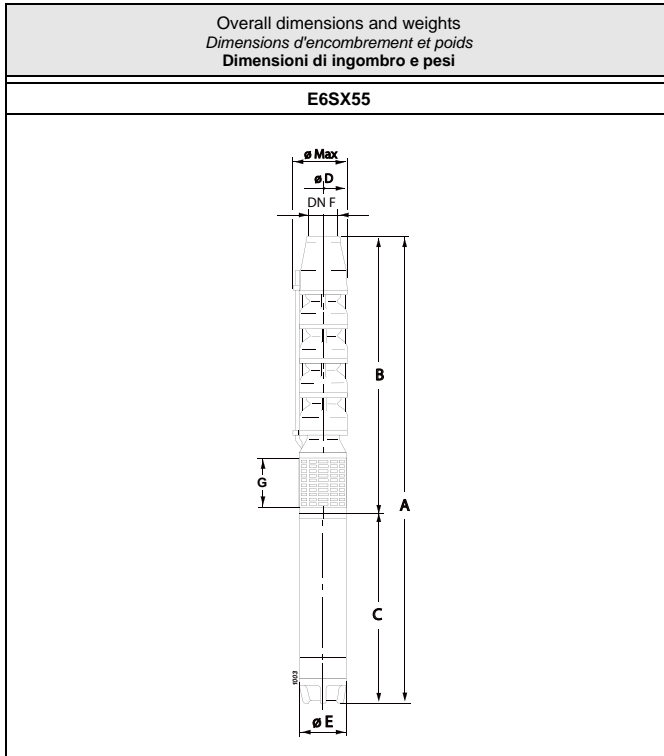

Type Type Tipo	Ø max [mm]	Weight Poids Peso [kg]	A	B	C	D	E	F	G
			[mm]						
E6SX55/2I+MACW65A	150	55,5	1182	612	570	141	143	G3	124
E6SX55/3P+MACW67A	150	68	1342	727	615	141	143	G3	124
E6SX55/4P+MACW610A	150	77,5	1512	842	670	141	143	G3	124
E6SX55/5Q+MACW612A	150	85	1657	957	700	141	143	G3	124
E6SX55/6Z+MACW615A	150	92	1787	1072	715	141	143	G3	124
E6SX55/7Z+MACW617A	150	91,5	1937	1187	750	141	143	G3	124
E6SX55/8S+MACW620A	150	112	2092	1302	790	141	143	G3	124
E6SX55/9A+MACW625A	150	120,5	2247	1417	830	141	143	G3	124
E6SX55/11M+MACW630A	150	139,5	2567	1647	920	141	143	G3	124
E6SX55/13M+MACW635A	150	163,5	2932	1877	1055	141	143	G3	124
E6SX55/15M+MACW640A	150	186	3272	2107	1165	141	143	G3	124
E6SX55/18A+MACW650B	150	220,5	3734	2452	1282	141	143	G3	124
E6SX55/21A+MACW660B	150	247,5	4119	2797	1322	141	143	G3	124

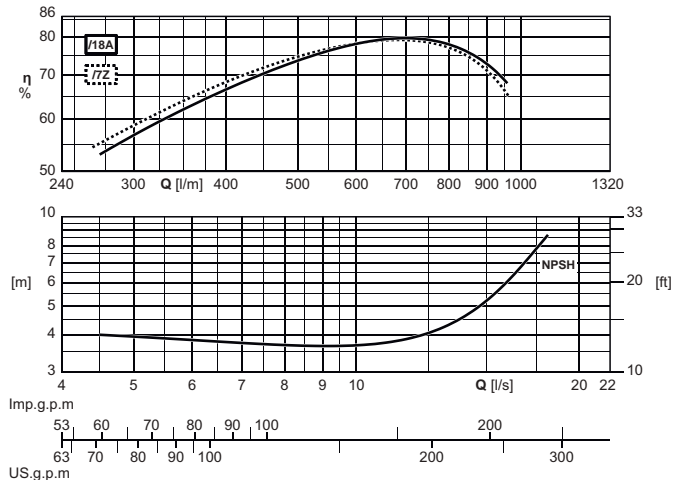
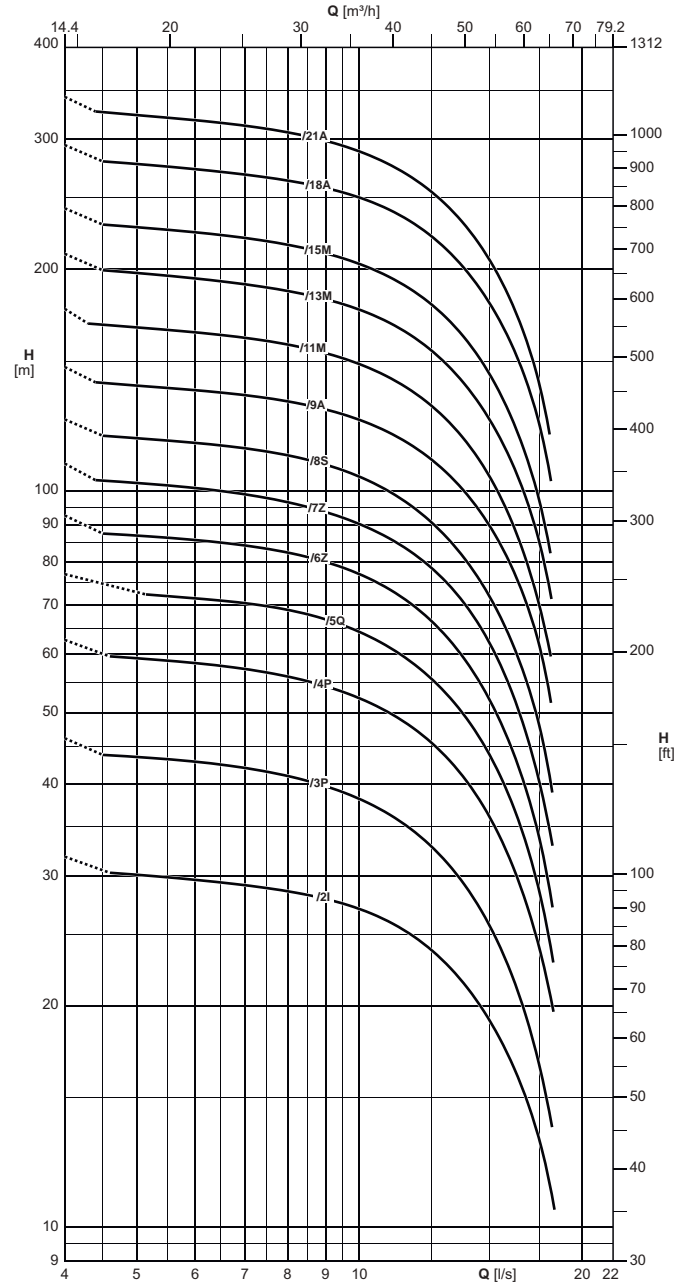

The hydraulic performance characteristics are guaranteed as conforming to standard UNI/ISO 9906 Grade 3B. Available with NPT thread.

Les caractéristiques hydrauliques de fonctionnement sont garanties conformes à la norme UNI/ISO 9906 Niveau 3B. Disponible avec filetage NPT.

Le caratteristiche di funzionamento vengono garantite secondo la norma: UNI/ISO 9906 Grado 3B. Disponibile con filettatura NPT.

Operating data
Caracteristiques de fonctionnement
Caratteristiche di funzionamento

Electric pump type Electropompe type Elettropompa tipo	Motor power Puis. moteur Potenza motore		Horizontal installation Installation horizontale Installazione orizzontale	Check valve \varnothing Clapet de retenue \varnothing Valvola di ritegno \varnothing	Capacity Debit Portata															
					[l/s]	0	5	6	7	8	9	10	11	12	13	14	15	16	17	18
	[l/min]	0			300	360	420	480	540	600	660	720	780	840	900	960	1020	1080		
	[m ³ /h]	0			18	21,6	25,2	28,8	32,4	36	39,6	43,2	46,8	50,4	54	57,6	61,2	64,8		
[kW]	[HP]	Head Hauteur Prevalenza																		
E6SX55/2I+MACW65A	4	5,5	■	3" Gas	[m]	32	30	29,5	29	28,5	28	27	26	24,5	23	21	19	17	14,5	11,5
E6SX55/3P+MACW67A	5,5	7,5	■	3" Gas	[m]	46	43,5	43	42	41	39,5	38	36,5	34	31,5	29	25,5	22	18,5	14,5
E6SX55/4P+MACW610A	7,5	10	■	3" Gas	[m]	63	59	58	57	56	54	52	50	47	43,5	40,5	36	31,5	26,5	21,5
E6SX55/5Q+MACW612A	9,2	12,5	■	3" Gas	[m]	77	-	71	70	69	67	64	61	58	53	48,5	43,5	38	32	25
E6SX55/6Z+MACW615A	11	15	■	3" Gas	[m]	92	87	86	84	82	80	77	73	69	64	58	52	45,5	37,5	29
E6SX55/7Z+MACW617A	13	17,5	■	3" Gas	[m]	109	102	101	99	96	93	90	86	81	75	69	62	53	45	35
E6SX55/8S+MACW620A	15	20	■	3" Gas	[m]	125	118	116	114	112	108	104	100	94	87	80	71	62	53	41,5
E6SX55/9A+MACW625A	18,5	25	■	3" Gas	[m]	147	139	137	135	132	129	125	120	114	107	98	89	80	68	53
E6SX55/11M+MACW630A	22	30	■	3" Gas	[m]	176	166	164	161	158	154	148	142	135	126	116	104	91	77	61
E6SX55/13M+MACW635A	26	35	○	3" Gas	[m]	210	197	194	191	187	182	176	169	160	149	137	125	110	93	75
E6SX55/15M+MACW640A	30	40	○	3" Gas	[m]	242	228	224	220	216	210	203	194	185	173	159	143	127	107	85
E6SX55/18A+MACW650B	37	50	○	3" Gas	[m]	295	278	273	269	264	258	250	241	228	214	197	179	159	135	106
E6SX55/21A+MACW660B	45	60	○	3" Gas	[m]	343	324	318	313	307	298	289	277	263	246	226	206	181	153	122
NPSH					[m]	-	4	3,8	3,9	4	4,1	3,9	3,8	4,4	4,3	4,9	5,3	6,1	7,3	8,5

M.E.I. $\geq 0,40$

■ Without conical valve

□ On request

○ Please contact our sales organisation

For motor performances specification see page "motor features"

Temperature monitoring device for submersed electric motors 6" ÷ 14": see page "Accessories"

■ Sans soupape du clapet.

□ Sur demande

○ Contacter notre service commercial.

Pour caractéristiques techniques moteurs voir page "Caractéristiques des moteurs"

Appareillage de contrôle de la température des moteurs électriques immergés 6" ÷ 14": voir page "Accessories"

■ Senza clapet valvola di ritegno

□ Su richiesta

○ Interpellare la sede o la rete di vendita

Per caratteristiche motori vedere pagina "caratteristiche motori"

Apparecchiatura di controllo temperatura motori elettrici sommersi 6" ÷ 14": vedere pagina accessori

Operating data
Caracteristiques de fonctionnement
Caratteristiche di funzionamento

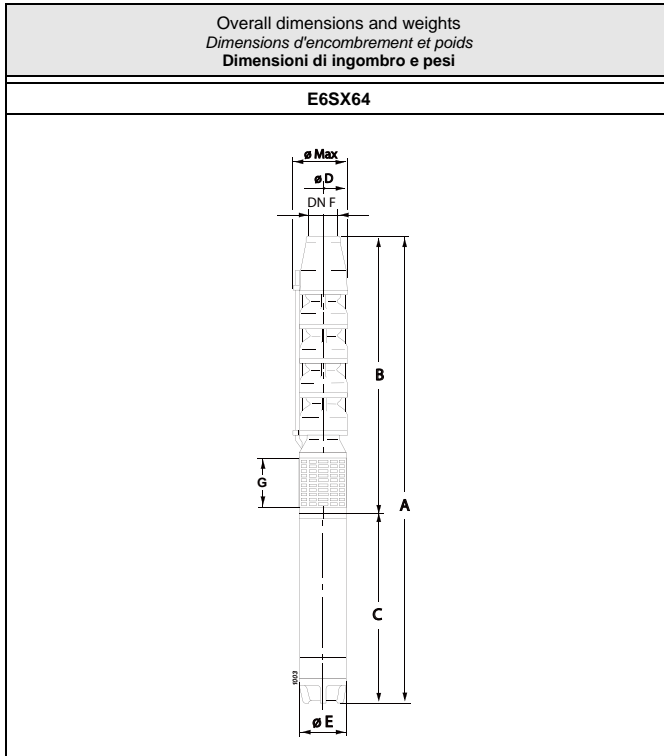

Type Type Tipo	Ø max	Weight Poids Peso	A	B	C	D	E	F	G
	[mm]								
E6SX64/2I+MACW65A	150	60,5	1182	612	570	141	143	G4	124
E6SX64/3K+MACW67A	150	69	1342	727	615	141	143	G4	124
E6SX64/4K+MACW610A	150	79,5	1512	842	670	141	143	G4	124
E6SX64/5M+MACW612A	150	83	1657	957	700	141	143	G4	124
E6SX64/6M+MACW615A	150	90	1787	1072	715	141	143	G4	124
E6SX64/7MN+MACW617A	150	100	1937	1187	750	141	143	G4	124
E6SX64/7A+MACW620A	150	109	1977	1187	790	141	143	G4	124
E6SX64/9A+MACW625A	150	137,5	2247	1417	830	141	143	G4	124
E6SX64/11K+MACW630A	150	136,5	2567	1647	920	141	143	G4	124
E6SX64/13K+MACW635A	150	165,5	2932	1877	1055	141	143	G4	124
E6SX64/15K+MACW640A	150	219	3272	2107	1165	141	143	G4	124
E6SX64/18A+MACW650B	150	211	3734	2452	1282	141	143	G4	124
E6SX64/21A+MACW660B	150	247,5	4119	2797	1322	141	143	G4	124

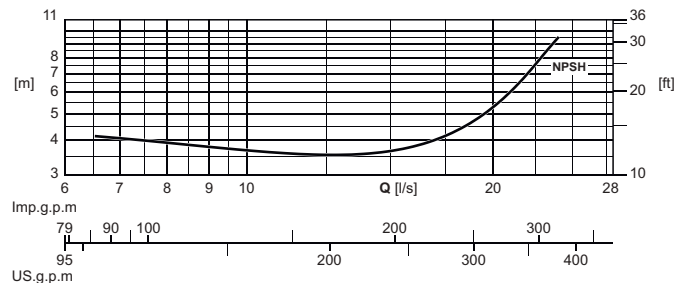
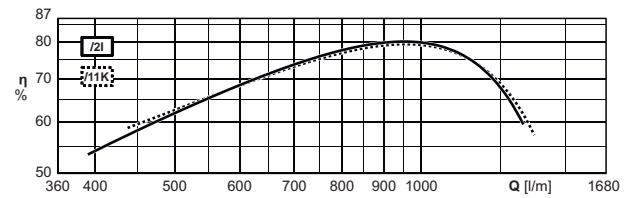
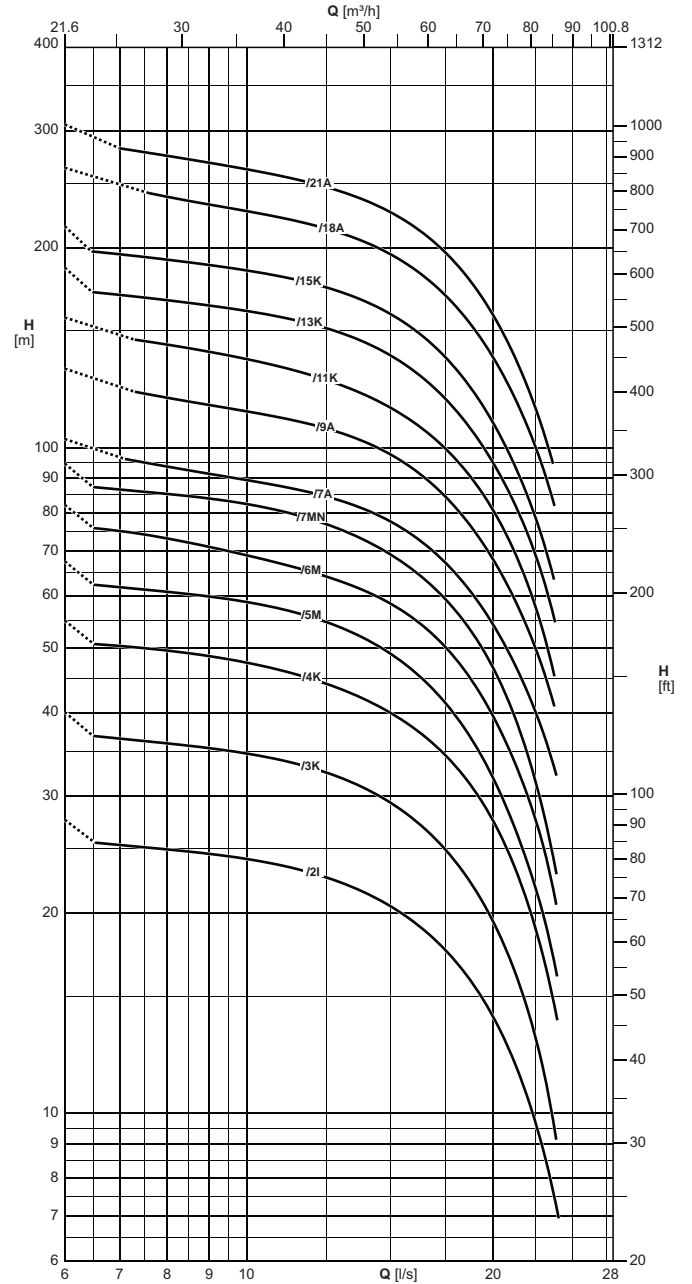

The hydraulic performance characteristics are guaranteed as conforming to standard UNI/ISO 9906 Grade 3B. Available with NPT thread.

Les caractéristiques hydrauliques de fonctionnement sont garanties conformes à la norme UNI/ISO 9906 Niveau 3B. Disponible avec filetage NPT.

Le caratteristiche di funzionamento vengono garantite secondo la norma: UNI/ISO 9906 Grado 3B. Disponibile con filettatura NPT.

Operating data
Caracteristiques de fonctionnement
Caratteristiche di funzionamento

Electric pump type Electropompe type Elettropompa tipo	Motor power Puis. moteur Potenza motore		Horizontal installation Installation horizontale Installazione orizzontale	Check valve \varnothing Clapet de retenue \varnothing Valvola di ritegno \varnothing	Capacity Debit Portata													
					[l/s]	0	7	7,5	8	8,5	9	9,5	10	12,5	15	17,5	20	22,5
	[l/min]	0			420	450	480	510	540	570	600	750	900	1050	1200	1350		
	[m ³ /h]	0			25,2	27	28,8	30,6	32,4	34,2	36	45	54	63	72	81		
[kW]	[HP]	Head Hauteur Prevalenza																
E6SX64/2I+MACW65A	4	5,5	■	4" Gas	[m]	27,5	25,5	25	25	25	24,5	24,5	24	22,5	20,5	17,5	14	9,7
E6SX64/3K+MACW67A	5,5	7,5	■	4" Gas	[m]	40	36,5	36,5	36	35,5	35,5	35	35	32,5	29	25	19,5	13
E6SX64/4K+MACW610A	7,5	10	■	4" Gas	[m]	55	50	50	49,5	49	48,5	48	47,5	44	40	34,5	27,5	19
E6SX64/5M+MACW612A	9,2	12,5	■	4" Gas	[m]	67	62	61	61	60	60	59	59	55	49	41,5	32	22
E6SX64/6M+MACW615A	11	15	■	4" Gas	[m]	82	75	74	73	72	71	70	69	64	58	50	39,5	27,5
E6SX64/7MN+MACW617A	13	17,5	■	4" Gas	[m]	95	86	86	85	84	84	83	82	77	69	59	46,5	32
E6SX64/7A+MACW620A	15	20	■	4" Gas	[m]	103	-	95	94	93	91	90	89	84	77	67	54	40
E6SX64/9A+MACW625A	18,5	25	■	4" Gas	[m]	131	-	121	119	117	116	115	113	107	98	84	68	50
E6SX64/11K+MACW630A	22	30	■	4" Gas	[m]	157	-	145	143	141	139	138	136	126	115	100	80	58
E6SX64/13K+MACW635A	26	35	○	4" Gas	[m]	186	170	168	167	165	164	162	160	151	138	118	94	69
E6SX64/15K+MACW640A	30	40	○	4" Gas	[m]	215	195	194	192	190	188	187	185	174	158	137	109	79
E6SX64/18A+MACW650B	37	50	○	4" Gas	[m]	264	-	-	239	235	232	230	227	214	195	169	137	101
E6SX64/21A+MACW660B	45	60	○	4" Gas	[m]	306	282	279	275	272	269	265	262	247	226	196	157	115
NPSH					[m]	-	4	4	3,9	3,9	3,8	3,9	3,7	3,6	3,8	4,1	5,6	7,5

M.E.I. $\geq 0,40$

■ Without conical valve

□ On request

○ Please contact our sales organisation

For motor performances specification see page "motor features"

Temperature monitoring device for submersed electric motors 6" ÷ 14": see page "Accessories"

■ Sans soupape du clapet.

□ Sur demande

○ Contacter notre service commercial.

Pour caractéristiques techniques moteurs voir page "Caractéristiques des moteurs"

Appareillage de contrôle de la température des moteurs électriques immergés 6" ÷ 14": voir page "Accessories"

■ Senza clapet valvola di ritegno

□ Su richiesta

○ Interpellare la sede o la rete di vendita

Per caratteristiche motori vedere pagina "caratteristiche motori"

Apparecchiatura di controllo temperatura motori elettrici sommersi 6" ÷ 14": vedere pagina accessori

Operating data
Caracteristiques de fonctionnement
Caratteristiche di funzionamento

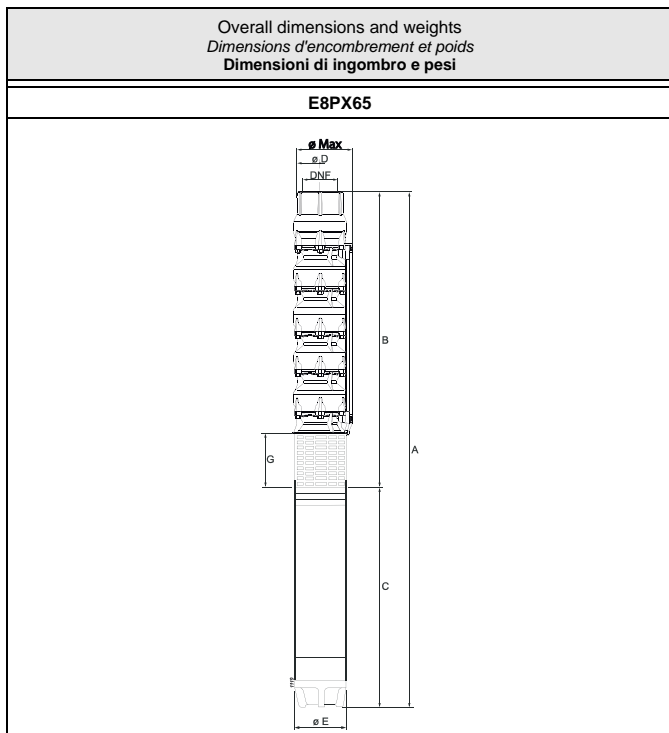

Type Type Tipo	ø max [mm]	Weight Poids Peso [kg]	A	B	C	D	E	F	G
			[mm]						
E8PX65/1D+MACW65A	203	59	1130	560	570	192	143	G5"	165,5
E8PX65/1A+MACW67A	203	64	1175	560	615	192	143	G5"	165,5
E8PX65/2T+MACW610A	203	77	1365	695	670	192	143	G5"	165,5
E8PX65/2C+MACW612A	203	80	1395	695	700	192	143	G5"	165,5
E8PX65/2A+MACW615A	203	84,5	1410	695	715	192	143	G5"	165,5
E8PX65/3E+MACW615A	203	92,5	1545	830	715	192	143	G5"	165,5
E8PX65/3JD+MACW617A	203	96,5	1580	830	750	192	143	G5"	165,5
E8PX65/3K+MACW620A	203	100,5	1620	830	790	192	143	G5"	165,5
E8PX65/4JC+MACW625A	203	113	1795	965	830	192	143	G5"	165,5
E8PX65/4A+MACW630A	203	123,5	1885	965	920	192	143	G5"	165,5
E8PX65/5KC+MACW630A	203	131,5	2020	1100	920	192	143	G5"	165,5
E8PX65/5A+MACW635A	203	146,5	2155	1100	1055	192	143	G5"	165,5
E8PX65/6U+MACW640A	203	167	2400	1235	1165	192	143	G5"	165,5
E8PX65/6U+MACW840	203	208	2320,5	1260,5	1060	192	191	G5"	193,5
E8PX65/6C+MACW640A	203	167	2400	1235	1165	192	143	G5"	165,5
E8PX65/6C+MACW840	203	208	2320,5	1260,5	1060	192	191	G5"	193,5
E8PX65/7A+MACW650B	203	192,5	2652	1370	1282	192	143	G5"	165,5
E8PX65/7A+MACW850	203	228,5	2510,5	1395,5	1115	192	191	G5"	193,5
E8PX65/9T+MACW660B	203	213	2962	1640	1322	192	143	G5"	165,5
E8PX65/9T+MACW860	203	261,5	2860,5	1665,5	1195	192	191	G5"	193,5
E8PX65/10Z+MACW870	203	289,5	3090,5	1800,5	1290	192	191	G5"	193,5
E8PX65/11A+MACW880	203	316	3330,5	1935,5	1395	192	191	G5"	193,5
E8PX65/12A+MACW890	203	333	3500,5	2070,5	1430	192	191	G5"	193,5
E8PX65/14A+MACW8100	203	365,5	3840,5	2340,5	1500	192	191	G5"	193,5
E8PX65/16A+MACW8125	203	411,5	4295,5	2610,5	1685	192	191	G5"	193,5
E8PX65/17A+MACW8125	203	420	4430,5	2745,5	1685	192	191	G5"	193,5

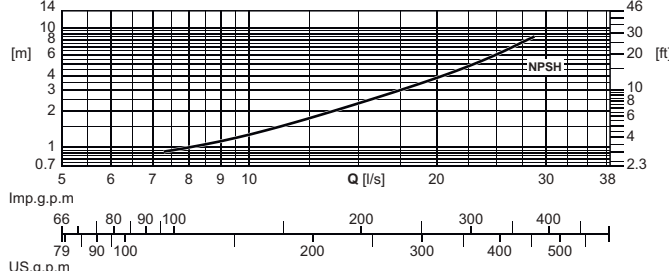
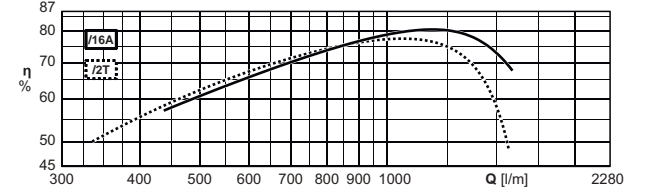
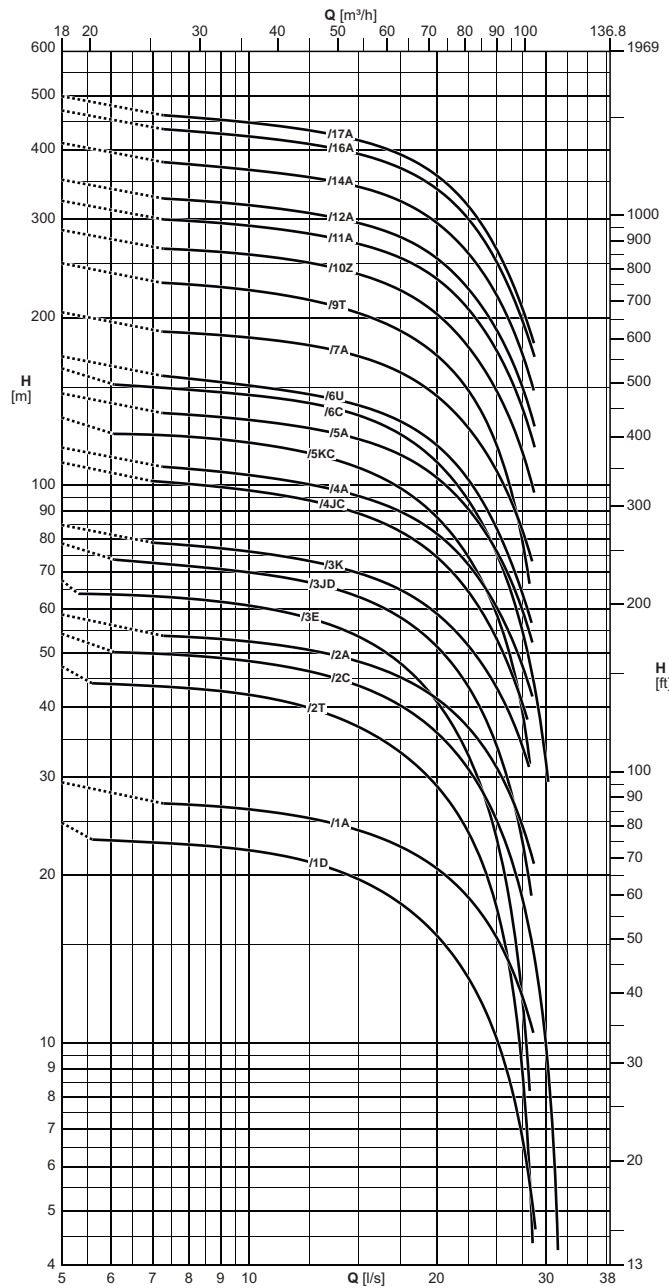

The hydraulic performance characteristics are guaranteed as conforming to standard UNI/ISO 9906 Grade 3B. Available with NPT thread.

Les caractéristiques hydrauliques de fonctionnement sont garanties conformes à la norme UNI/ISO 9906 Niveau 3B. Disponible avec filetage NPT.

Le caratteristiche di funzionamento vengono garantite secondo la norma: UNI/ISO 9906 Grado 3B. Disponibile con filettatura NPT.

Operating data
Caracteristiques de fonctionnement
Caratteristiche di funzionamento

Electric pump type Electropompe type Elettropompa tipo	Motor power Puisse. moteur Potenza motore		Horizontal installation Installation horizontale Installazione orizzontale	Check valve \varnothing Clapet de retenue \varnothing Valvola di ritegno \varnothing	Capacity Debit Portata														
	[kW]	[HP]			[l/s]	0	6	7	8	9	10	12,5	15	17,5	20	22,5	25	27,5	30
					[l/min]	0	360	420	480	540	600	750	900	1050	1200	1350	1500	1650	1800
					[m ³ /h]	0	21,6	25,2	28,8	32,4	36	45	54	63	72	81	90	99	108
Head Hauteur Prevalenza																			
[m]	25	23	23	22,5	22,5	22	21	19,5	18	15,5	13	10	6,7	-					
E8PX65/1D+MACW65A	4	5,5	■	5" Gas	[m]	25	23	23	22,5	22,5	22	21	19,5	18	15,5	13	10	6,7	-
E8PX65/1A+MACW67A	5,5	7,5	■	5" Gas	[m]	29,5	-	-	27	26,5	26	25,5	24	22,5	20,5	18	15,5	12	-
E8PX65/2T+MACW610A	7,5	10	■	5" Gas	[m]	47,5	44	43,5	43,5	42,5	42	40	37	33,5	29	24	17,5	8,6	-
E8PX65/2C+MACW612A	9,2	12,5	■	5" Gas	[m]	54	-	50	49,5	49	48,5	46,5	43,5	40	36	31	25	18	9,8
E8PX65/2A+MACW615A	11	15	■	5" Gas	[m]	59	-	-	53	53	52	51	48,5	45,5	41,5	36,5	31	24,5	-
E8PX65/3E+MACW615A	11	15	■	5" Gas	[m]	67	64	63	63	62	61	58	54	48	41	33	23	11,5	-
E8PX65/3JD+MACW617A	13	17,5	■	5" Gas	[m]	79	-	72	71	71	70	67	63	58	51	43,5	34	22,5	-
E8PX65/3K+MACW620A	15	20	■	5" Gas	[m]	85	-	79	78	77	76	73	69	65	59	52	43	34	-
E8PX65/4C+MACW625A	18,5	25	■	5" Gas	[m]	110	-	102	100	99	98	94	89	82	74	64	53	40,5	-
E8PX65/4A+MACW630A	22	30	■	5" Gas	[m]	117	-	-	107	106	104	100	96	89	82	72	60	47,5	-
E8PX65/5KC+MACW630A	22	30	■	5" Gas	[m]	132	-	123	122	121	119	114	107	99	88	74	58	38,5	-
E8PX65/5A+MACW635A	26	35	■	5" Gas	[m]	146	-	-	134	132	131	126	121	113	103	90	76	60	-
E8PX65/6U+MACW640A	30	40	○	5" Gas	[m]	170	-	-	155	153	151	145	139	130	118	102	84	64	-
E8PX65/6U+MACW840	30	40	■	5" Gas	[m]	171	-	-	157	156	154	149	141	132	120	104	87	67	-
E8PX65/6C+MACW640A	30	40	○	5" Gas	[m]	162	-	150	148	147	145	140	133	123	110	94	75	55	31,5
E8PX65/6C+MACW840	30	40	■	5" Gas	[m]	163	-	151	150	149	147	142	135	125	113	97	79	58	-
E8PX65/7A+MACW650B	37	50	○	5" Gas	[m]	204	-	-	187	186	184	178	170	159	144	127	106	83	-
E8PX65/7A+MACW850	37	50	■	5" Gas	[m]	205	-	-	189	187	185	179	171	162	148	130	109	86	-
E8PX65/9T+MACW660B	45	60	○	5" Gas	[m]	250	-	-	229	227	224	215	204	189	171	148	118	79	-
E8PX65/9T+MACW860	45	60	■	5" Gas	[m]	253	-	-	233	231	229	221	210	197	178	155	126	89	-
E8PX65/10Z+MACW870	51	70	■	5" Gas	[m]	287	-	-	264	262	259	250	239	223	203	177	147	115	-
E8PX65/11A+MACW880	59	80	■	5" Gas	[m]	324	-	-	298	295	292	282	271	256	234	207	174	137	-
E8PX65/12A+MACW890	66	90	■	5" Gas	[m]	353	-	-	325	321	318	308	295	279	255	225	190	149	-
E8PX65/14A+MACW8100	75	100	○	5" Gas	[m]	411	-	-	377	372	368	357	343	323	296	260	219	171	-
E8PX65/16A+MACW8125	92	125	○	5" Gas	[m]	470	-	-	432	427	422	409	393	371	340	301	251	197	-
E8PX65/17A+MACW8125	92	125	○	5" Gas	[m]	499	-	-	457	452	447	433	416	392	360	316	265	206	-
NPSH					[m]	-	0,9	0,9	1	1,2	1,4	1,9	2,2	3	3,9	5	5,7	7,7	9,6

■ Without conical valve

□ On request

○ Please contact our sales organisation

For motor performances specification see page "motor features"

Temperature monitoring device for submersed electric motors 6" ÷ 14": see page "Accessories"

■ Sans soupape du clapet.

□ Sur demande

○ Contacter notre service commercial.

Pour caractéristiques techniques moteurs voir page "Caractéristiques des moteurs"

Appareillage de contrôle de la température des moteurs électriques immergés 6" ÷ 14": voir page "Accessories"

■ Senza clapet valvola di ritegno

□ Su richiesta

○ Interpellare la sede o la rete di vendita

Per caratteristiche motori vedere pagina "caratteristiche motori"

Apparecchiatura di controllo temperatura motori elettrici sommersi 6" ÷ 14": vedere pagina accessori

Operating data
 Caracteristiques de fonctionnement
 Caratteristiche di funzionamento

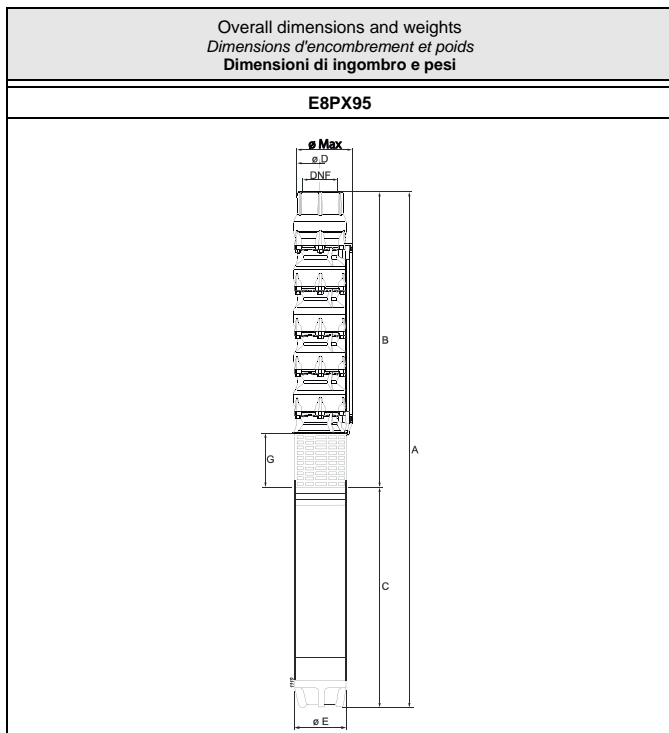

Type Type Tipo	ø max [mm]	Weight Poids Peso [kg]	A	B	C	D	E	F	G
E8PX95/1C+MACW610A	203	70	1235	565	670	192	143	G5"	165,5
E8PX95/1A+MACW612A	203	73,5	1265	565	700	192	143	G5"	165,5
E8PX95/2F+MACW612A	203	81,5	1405	705	700	192	143	G5"	165,5
E8PX95/2DF+MACW615A	203	86	1420	705	715	192	143	G5"	165,5
E8PX95/2D+MACW617A	203	90	1455	705	750	192	143	G5"	165,5
E8PX95/2C+MACW620A	203	94	1495	705	790	192	143	G5"	165,5
E8PX95/2A+MACW625A	203	98	1535	705	830	192	143	G5"	165,5
E8PX95/3DJ+MACW625A	203	106,5	1675	845	830	192	143	G5"	165,5
E8PX95/3C+MACW630A	203	116,5	1765	845	920	192	143	G5"	165,5
E8PX95/3A+MACW635A	203	131,5	1900	845	1055	192	143	G5"	165,5
E8PX95/4D+MACW635A	203	139,5	2040	985	1055	192	143	G5"	165,5
E8PX95/4C+MACW640A	203	152,5	2150	985	1165	192	143	G5"	165,5
E8PX95/4C+MACW840	203	193,5	2070,5	1010,5	1060	192	191	G5"	193,5
E8PX95/4A+MACW650B	203	169,5	2267	985	1282	192	143	G5"	165,5
E8PX95/4A+MACW850	203	205,5	2125,5	1010,5	1115	192	191	G5"	193,5
E8PX95/5KC+MACW650B	203	177,5	2407	1125	1282	192	143	G5"	165,5
E8PX95/5KC+MACW850	203	213,5	2265,5	1150,5	1115	192	191	G5"	193,5
E8PX95/5A+MACW660B	203	182	2447	1125	1322	192	143	G5"	165,5
E8PX95/5A+MACW860	203	230,5	2345,5	1150,5	1195	192	191	G5"	193,5
E8PX95/6QC+MACW660B	203	190	2447	1125	1322	192	143	G5"	165,5
E8PX95/6QC+MACW860	203	239	2485,5	1290,5	1195	192	191	G5"	193,5
E8PX95/7ZC+MACW870	203	267	2720,5	1430,5	1290	192	191	G5"	193,5
E8PX95/7Z+MACW880	203	285	2825,5	1430,5	1395	192	191	G5"	193,5
E8PX95/8Z+MACW890	203	302	3000,5	1570,5	1430	192	191	G5"	193,5
E8PX95/10XC+MACW8100	203	335	3350,5	1850,5	1500	192	191	G5"	193,5
E8PX95/10A+MACW8125	203	365	3535,5	1850,5	1685	192	191	G5"	193,5
E8PX95/12C+MACW8125	203	381	3815,5	2130,5	1685	192	191	G5"	193,5

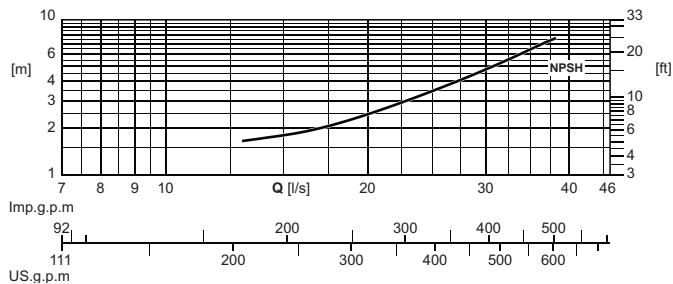
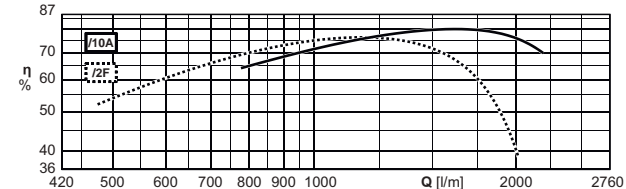
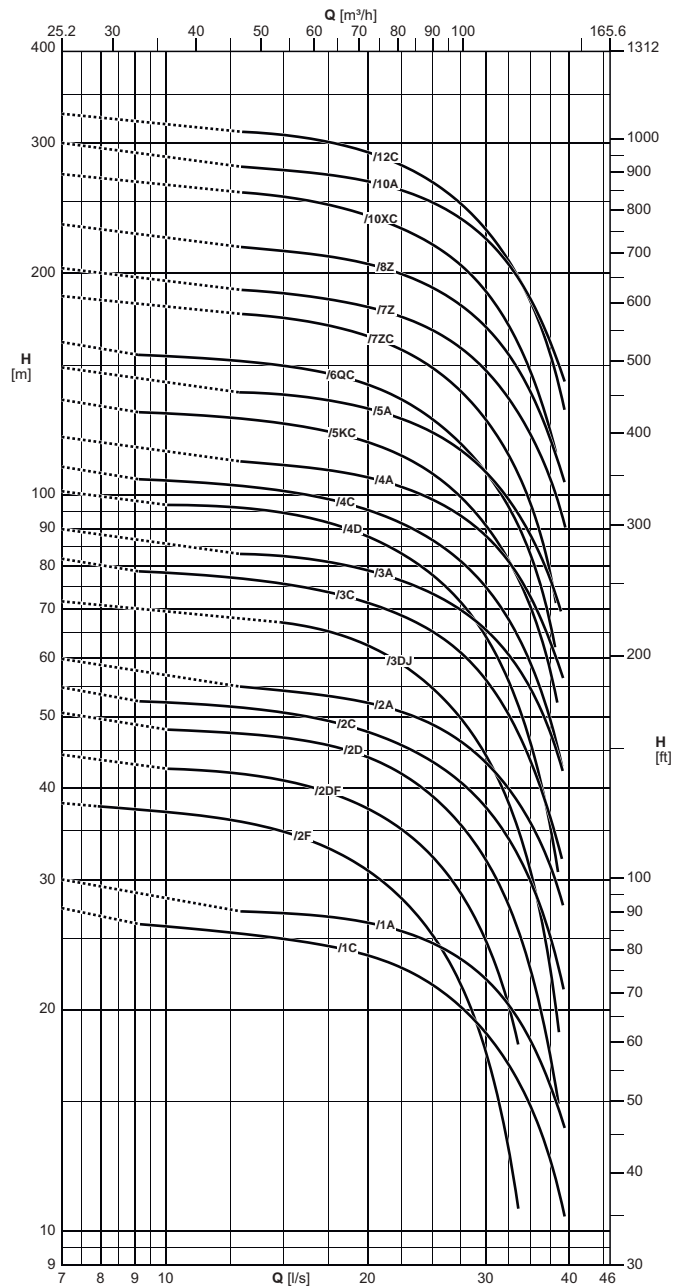

The hydraulic performance characteristics are guaranteed as conforming to standard UNI/ISO 9906 Grade 3B.
 Available with NPT thread.

Les caractéristiques hydrauliques de fonctionnement sont garanties conformes à la norme UNI/ISO 9906 Niveau 3B.
 Disponible avec filetage NPT.

Le caratteristiche di funzionamento vengono garantite secondo la norma: UNI/ISO 9906 Grado 3B.
 Disponibile con filettatura NPT.

Operating data
Caracteristiques de fonctionnement
Caratteristiche di funzionamento

Electric pump type Electropompe type Elettropompa tipo	Motor power Puisse. moteur Potenza motore		Horizontal installation Installation horizontale Installazione orizzontale	Check valve \varnothing Clapet de retenue \varnothing Valvola di ritegno \varnothing	Capacity Debit Portata																
	[kW]	[HP]			[l/s]	0	8	9	10	12,5	15	17,5	20	22,5	25	27,5	30	32,5	35	37,5	
					[l/min]	0	480	540	600	750	900	1050	1200	1350	1500	1650	1800	1950	2100	2250	
					[m ³ /h]	0	28,8	32,4	36	45	54	63	72	81	90	99	108	117	126	135	
Head Hauteur Prevalenza																					
E8PX95/1C+MACW610A	7,5	10	■	5" Gas	[m]	27,5	-	-	26	25,5	25	24,5	23,5	23	21,5	20	18,5	17	15	12,5	
E8PX95/1A+MACW612A	9,2	12,5	■	5" Gas	[m]	30	-	-	-	-	27	26,5	26	25,5	24,5	23,5	22	20,5	18	15,5	
E8PX95/2F+MACW612A	9,2	12,5	■	5" Gas	[m]	38	37,5	37,5	37	36	35	33	31	28,5	25,5	21,5	17,5	13	-	-	
E8PX95/2DF+MACW615A	11	15	■	5" Gas	[m]	44,5	-	-	-	42	41	39,5	37,5	35	32,5	29	25	20	-	-	
E8PX95/2D+MACW617A	13	17,5	■	5" Gas	[m]	51	-	-	-	47,5	47	45,5	44	42	39	35,5	32	27,5	22,5	17	
E8PX95/2C+MACW620A	15	20	■	5" Gas	[m]	55	-	-	52	52	51	49,5	47,5	45,5	43,5	40,5	37,5	34	30	25	
E8PX95/2A+MACW625A	18,5	25	■	5" Gas	[m]	60	-	-	-	-	54	53	52	51	48,5	46,5	43,5	40	36	31,5	
E8PX95/3DJ+MACW625A	18,5	25	■	5" Gas	[m]	72	-	-	-	-	67	65	62	59	55	49,5	44,5	38	30,5	22,5	
E8PX95/3C+MACW630A	22	30	■	5" Gas	[m]	82	-	-	78	77	76	74	71	68	65	61	56	50	43,5	36,5	
E8PX95/3A+MACW635A	26	35	■	5" Gas	[m]	90	-	-	-	-	82	81	79	76	73	70	65	61	55	47,5	
E8PX95/4D+MACW635A	26	35	■	5" Gas	[m]	101	-	-	-	96	94	91	88	83	78	71	64	56	46	35,5	
E8PX95/4C+MACW640A	30	40	○	5" Gas	[m]	109	-	-	104	103	101	98	95	91	87	81	75	67	59	49	
E8PX95/4C+MACW840	30	40	■	5" Gas	[m]	110	-	-	-	-	102	99	96	93	88	82	76	68	60	50	
E8PX95/4A+MACW650B	37	50	○	5" Gas	[m]	120	-	-	-	-	110	108	105	102	98	94	88	81	73	63	
E8PX95/4A+MACW850	37	50	■	5" Gas	[m]	120	-	-	-	-	111	109	107	104	100	95	89	83	74	65	
E8PX95/5KC+MACW650B	37	50	○	5" Gas	[m]	134	-	-	129	127	125	122	118	113	107	99	91	81	70	57	
E8PX95/5KC+MACW850	37	50	■	5" Gas	[m]	135	-	-	-	-	126	123	119	114	108	101	93	84	72	59	
E8PX95/5A+MACW660B	45	60	○	5" Gas	[m]	149	-	-	-	-	137	134	131	127	121	115	107	98	88	76	
E8PX95/5A+MACW860	45	60	■	5" Gas	[m]	150	-	-	-	-	138	136	133	130	125	119	112	103	93	81	
E8PX95/6QC+MACW660B	45	60	○	5" Gas	[m]	161	-	-	154	152	150	146	141	134	127	117	107	96	83	66	
E8PX95/6QC+MACW860	45	60	■	5" Gas	[m]	163	-	-	-	-	150	147	143	138	131	122	112	101	87	72	
E8PX95/7ZC+MACW870	51	70	■	5" Gas	[m]	186	-	-	-	-	174	170	164	157	148	138	126	113	97	78	
E8PX95/7Z+MACW880	59	80	■	5" Gas	[m]	203	-	-	-	-	188	184	180	174	167	158	147	135	121	105	
E8PX95/8Z+MACW890	66	90	■	5" Gas	[m]	233	-	-	-	-	214	211	206	199	191	181	169	155	138	119	
E8PX95/10XC+MACW8100	75	100	○	5" Gas	[m]	272	-	-	-	-	254	247	239	230	218	205	189	170	146	122	
E8PX95/10A+MACW8125	92	125	○	5" Gas	[m]	300	-	-	-	-	276	272	266	259	249	237	222	205	184	161	
E8PX95/12C+MACW8125	92	125	○	5" Gas	[m]	329	-	-	-	-	308	301	292	280	266	249	229	207	183	155	
NPSH					[m]	-	1,3	1,5	1,5	1,8	1,9	2,1	2,5	2,9	3,5	4,1	4,8	5,6	6,4	7,6	

■ Without conical valve

□ On request

○ Please contact our sales organisation

For motor performances specification see page "motor features"

Temperature monitoring device for submersed electric motors 6" ÷ 14": see page "Accessories"

■ Sans soupape du clapet.

□ Sur demande

○ Contacter notre service commercial.

Pour caractéristiques techniques moteurs voir page "Caractéristiques des moteurs"

Appareillage de contrôle de la température des moteurs électriques immergés 6" ÷ 14": voir page "Accessories"

■ Senza clapet valvola di ritegno

□ Su richiesta

○ Interpellare la sede o la rete di vendita

Per caratteristiche motori vedere pagina "caratteristiche motori"

Apparecchiatura di controllo temperatura motori elettrici sommersi 6" ÷ 14": vedere pagina accessori

Operating data
Caracteristiques de fonctionnement
Caratteristiche di funzionamento

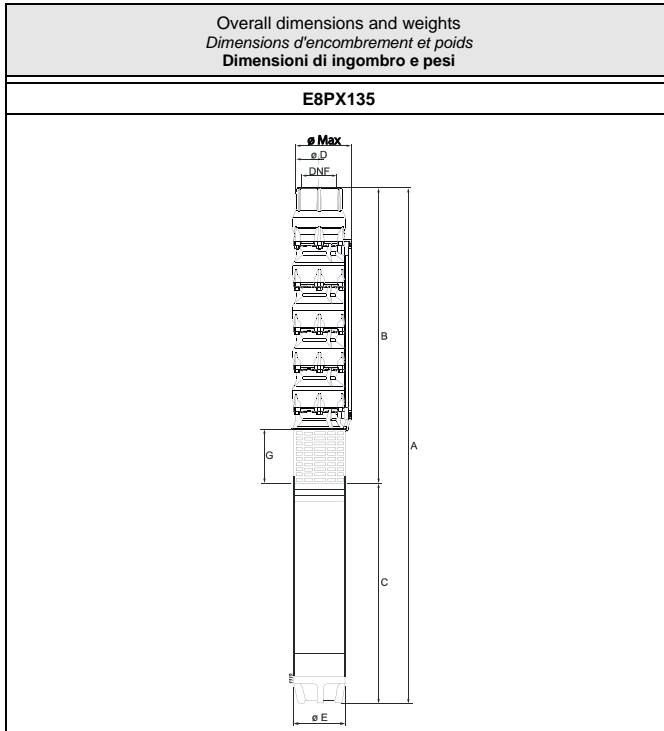

Type Type Tipo	ø max [mm]	Weight Poids Peso [kg]	A	B	C	D	E	F	G
E8PX135/1D+MACW610A	203	69	1235	565	670	192	143	G5"	165,5
E8PX135/1B+MACW612A	203	72,5	1265	565	700	192	143	G5"	165,5
E8PX135/1F+MACW67A	203	64,5	1180	565	615	192	143	G5"	165,5
E8PX135/2G+MACW612A	203	80	1405	705	700	192	143	G5"	165,5
E8PX135/2F+MACW615A	203	84,5	1420	705	715	192	143	G5"	165,5
E8PX135/2E+MACW617A	203	88,5	1455	705	750	192	143	G5"	165,5
E8PX135/2D+MACW620A	203	92,5	1495	705	790	192	143	G5"	165,5
E8PX135/2B+MACW625A	203	96,5	1535	705	830	192	143	G5"	165,5
E8PX135/3E+MACW625A	203	104,5	1675	845	830	192	143	G5"	165,5
E8PX135/3D+MACW630A	203	114,5	1765	845	920	192	143	G5"	165,5
E8PX135/3B+MACW635A	203	129,5	1900	845	1055	192	143	G5"	165,5
E8PX135/4D+MACW640A	203	150	2150	985	1165	192	143	G5"	165,5
E8PX135/4D+MACW840	203	191	2070,5	1010,5	1060	192	191	G5"	193,5
E8PX135/4C+MACW650B	203	167	2267	985	1282	192	143	G5"	165,5
E8PX135/4C+MACW850	203	203	2125,5	1010,5	1115	192	191	G5"	193,5
E8PX135/5D+MACW650B	203	174,5	2407	1125	1282	192	143	G5"	165,5
E8PX135/5D+MACW850	203	210,5	2265,5	1150,5	1115	192	191	G5"	193,5
E8PX135/5B+MACW660B	203	179	2447	1125	1322	192	143	G5"	165,5
E8PX135/5B+MACW860	203	227,5	2345,5	1150,5	1195	192	191	G5"	193,5
E8PX135/6C+MACW870	203	255,5	2580,5	1290,5	1290	192	191	G5"	193,5
E8PX135/7C+MACW880	203	281	2825,5	1430,5	1395	192	191	G5"	193,5
E8PX135/7A+MACW890	203	290	2860,5	1430,5	1430	192	191	G5"	193,5
E8PX135/8A+MACW8100	203	313,5	3070,5	1570,5	1500	192	191	G5"	193,5
E8PX135/8C+MACW890	203	297,5	3000,5	1570,5	1430	192	191	G5"	193,5
E8PX135/9C+MACW8100	203	321,5	3210,5	1710,5	1500	192	191	G5"	193,5
E8PX135/10C+MACW8125	203	359	3535,5	1850,5	1685	192	191	G5"	193,5
E8PX135/11C+MACW8125	203	367	3675,5	1990,5	1685	192	191	G5"	193,5

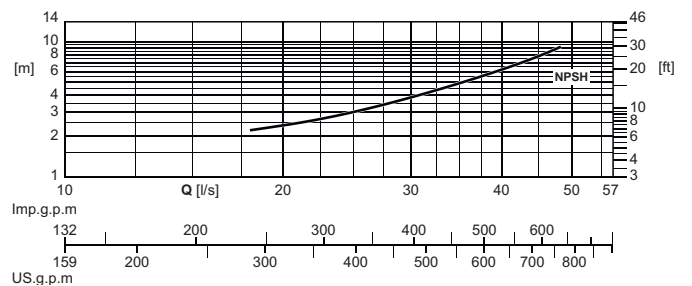
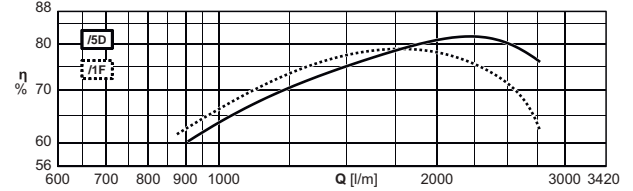
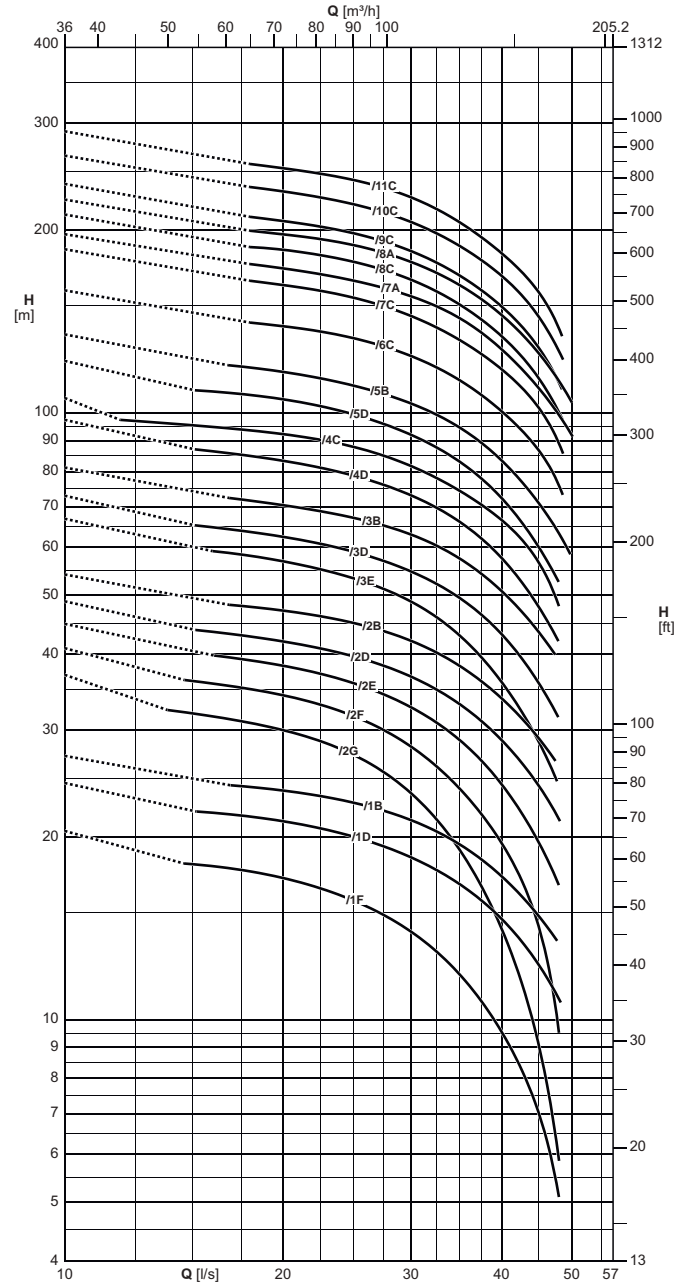

The hydraulic performance characteristics are guaranteed as conforming to standard UNI/ISO 9906 Grade 3B. Available with NPT thread.

Les caractéristiques hydrauliques de fonctionnement sont garanties conformes à la norme UNI/ISO 9906 Niveau 3B. Disponible avec filetage NPT.

Le caratteristiche di funzionamento vengono garantite secondo la norma: UNI/ISO 9906 Grado 3B. Disponibile con filettatura NPT.

Operating data
Caracteristiques de fonctionnement
Caratteristiche di funzionamento

Electric pump type Electropompe type Elettropompa tipo	Motor power Puis. moteur Potenza motore		Horizontal installation Installation horizontale Installazione orizzontale	Check valve Ø Clapet de retenue Ø Valvola di ritegno Ø	Capacity Debit Portata																
	[kW]	[HP]			[l/s]	0	15	17,5	20	22,5	25	27,5	30	32,5	35	37,5	40	42,5	45	47,5	50
					[l/min]	0	900	1050	1200	1350	1500	1650	1800	1950	2100	2250	2400	2550	2700	2850	3000
					[m³/h]	0	54	63	72	81	90	99	108	117	126	135	144	153	162	171	180
Head Hauteur Prevalenza																					
E8PX135/1D+MACW610A	7,5	10	■	5" Gas	[m]	24,5	-	21,5	21	20,5	20	19,5	18,5	17,5	16,5	15,5	14,5	13,5	12,5	11	-
E8PX135/1B+MACW612A	9,2	12,5	■	5" Gas	[m]	27	-	24	24	23,5	23	22	21,5	20,5	19,5	18,5	17	16	15	13,5	-
E8PX135/1F+MACW67A	5,5	7,5	■	5" Gas	[m]	20,5	18	17,5	17	16,5	15,5	15	14	13	12	11	9,6	8,3	7	5,4	-
E8PX135/2G+MACW612A	9,2	12,5	■	5" Gas	[m]	37	32	31	30	28,5	27,5	25,5	23,5	21,5	19	16,5	14	11,5	9,1	6,4	-
E8PX135/2F+MACW615A	11	15	■	5" Gas	[m]	41	36	35	34	33	31,5	30	28	26	24	22	19,5	17	14	10,5	-
E8PX135/2E+MACW617A	13	17,5	■	5" Gas	[m]	45	-	39,5	38,5	37	36	34,5	32,5	31	29	26,5	24,5	22	19,5	17	-
E8PX135/2D+MACW620A	15	20	■	5" Gas	[m]	49	-	43	42	41	39,5	38,5	37	35	33	31	29	26,5	24,5	22	-
E8PX135/2B+MACW625A	18,5	25	■	5" Gas	[m]	54	-	48	47	46	45	43,5	42	40,5	38,5	36	34	31,5	29	26,5	-
E8PX135/3E+MACW625A	18,5	25	■	5" Gas	[m]	67	-	58	57	55	53	51	49	46	43	39,5	36	32,5	28,5	25	-
E8PX135/3D+MACW630A	22	30	■	5" Gas	[m]	73	-	64	62	61	59	57	55	52	49,5	46,5	43	39,5	36	32	-
E8PX135/3B+MACW635A	26	35	■	5" Gas	[m]	81	-	72	70	69	67	65	63	60	58	54	51	47	43,5	-	-
E8PX135/4D+MACW640A	30	40	○	5" Gas	[m]	97	-	85	83	81	79	76	73	70	66	62	58	53	48	43	-
E8PX135/4D+MACW840	30	40	■	5" Gas	[m]	98	-	-	84	82	80	77	74	70	67	63	59	54	49	44	-
E8PX135/4C+MACW650B	37	50	○	5" Gas	[m]	106	95	94	92	90	88	85	82	78	74	70	66	62	57	49,5	-
E8PX135/4C+MACW850	37	50	■	5" Gas	[m]	106	-	-	93	91	89	86	83	79	76	72	67	63	58	52	-
E8PX135/5D+MACW650B	37	50	○	5" Gas	[m]	122	-	107	105	102	99	96	92	88	83	78	72	66	60	54	-
E8PX135/5D+MACW850	37	50	■	5" Gas	[m]	122	-	-	106	103	100	96	93	88	84	79	74	68	62	55	-
E8PX135/5B+MACW660B	45	60	○	5" Gas	[m]	134	-	119	117	114	111	107	103	99	94	89	83	77	71	64	-
E8PX135/5B+MACW860	45	60	■	5" Gas	[m]	136	-	121	119	116	114	111	107	103	98	92	86	80	74	68	-
E8PX135/6C+MACW870	51	70	■	5" Gas	[m]	159	-	-	139	136	132	129	124	119	113	107	100	94	87	78	-
E8PX135/7C+MACW880	59	80	■	5" Gas	[m]	186	-	-	162	159	155	150	144	138	132	125	118	110	102	91	-
E8PX135/7A+MACW890	66	90	■	5" Gas	[m]	197	-	-	173	169	165	160	155	150	143	135	127	119	110	101	92
E8PX135/8A+MACW8100	75	100	○	5" Gas	[m]	224	-	-	197	193	189	183	177	170	162	154	145	135	125	115	104
E8PX135/8C+MACW890	66	90	○	5" Gas	[m]	212	-	-	185	182	177	172	166	159	151	142	134	124	114	102	-
E8PX135/9C+MACW8100	75	100	○	5" Gas	[m]	238	-	-	207	202	197	191	184	177	168	159	150	139	128	115	-
E8PX135/10C+MACW8125	92	125	○	5" Gas	[m]	265	-	-	231	226	221	214	206	198	188	179	168	157	144	129	-
E8PX135/11C+MACW8125	92	125	○	5" Gas	[m]	291	-	-	253	248	242	235	226	216	206	195	183	171	158	141	-
NPSH					[m]	-	2	2,2	2,5	2,8	3,1	3,5	4	4,5	5	5,6	6,2	7	7,8	9	10

■ Without conical valve

□ On request

○ Please contact our sales organisation

For motor performances specification see page "motor features"

Temperature monitoring device for submersed electric motors 6" ÷ 14": see page "Accessories"

■ Sans soupape du clapet.

□ Sur demande

○ Contacter notre service commercial.

Pour caractéristiques techniques moteurs voir page "Caractéristiques des moteurs"

Appareillage de contrôle de la température des moteurs électriques immergés 6" ÷ 14": voir page "Accessories"

■ Senza clapet valvola di ritegno

□ Su richiesta

○ Interpellare la sede o la rete di vendita

Per caratteristiche motori vedere pagina "caratteristiche motori"

Apparecchiatura di controllo temperatura motori elettrici sommersi 6" ÷ 14": vedere pagina accessori

Operating data
Caracteristiques de fonctionnement
Caratteristiche di funzionamento

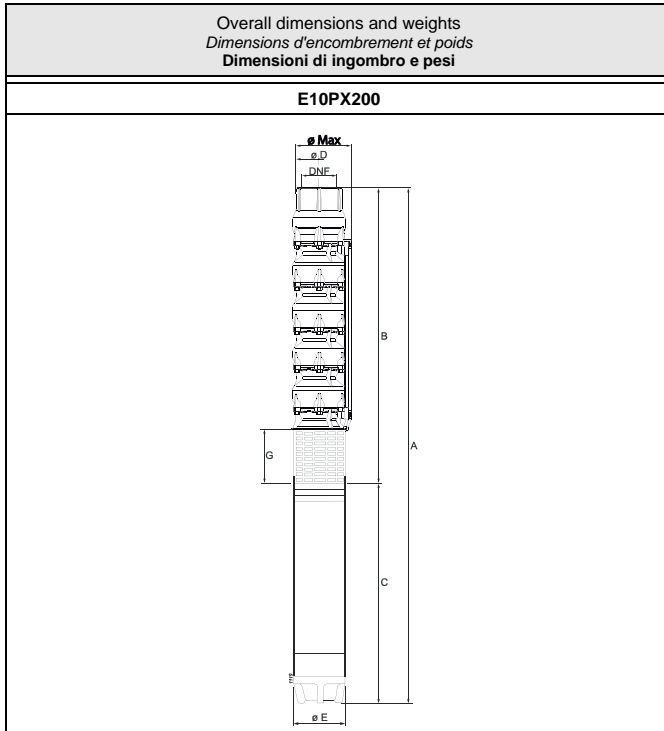

Type Type Tipo	Ø [mm]	Weight Poids Peso [kg]	A	B	C	D	E	F	G
			[mm]						
E10PX200/1F+MACW615A	250,5	115	1429	714	715	235	143	G6"	173
E10PX200/1E+MACW617A	250,5	119	1464	714	750	235	143	G6"	173
E10PX200/1DE+MACW620A	250,5	123,3	1504	714	790	235	143	G6"	173
E10PX200/1D+MACW625A	250,5	127,7	1544	714	830	235	143	G6"	173
E10PX200/1C+MACW630A	250,5	138	1634	714	920	235	143	G6"	173
E10PX200/1B+MACW635A	250,5	153,3	1769	714	1055	235	143	G6"	173
E10PX200/2E+MACW635A	250,5	168,3	1944	889	1055	235	143	G6"	173
E10PX200/2DE+MACW640A	250,5	180,9	2054	889	1165	235	143	G6"	173
E10PX200/2DE+MACW840	251	222	1974,5	914,5	1060	235	191	G6"	205
E10PX200/2CD+MACW650B	250,5	198,5	2171	889	1282	235	143	G6"	173
E10PX200/2CD+MACW850	251	234,5	2029,5	914,5	1115	235	191	G6"	205
E10PX200/2BC+MACW660B	250,5	203,3	2211	889	1322	235	143	G6"	173
E10PX200/2BC+MACW860	251	252	2109,5	914,5	1195	235	191	G6"	205
E10PX200/2AB+MACW870	251	272,5	2204,5	914,5	1290	235	191	G6"	205
E10PX200/3AB+MACW8100	251	332	2589,5	1089,5	1500	235	191	G6"	205
E10PX200/3AB+MACW10100A	254	397	2495,5	1089,5	1406	235	242	G6"	173
E10PX200/3D+MACW870	251	287	2379,5	1089,5	1290	235	191	G6"	205
E10PX200/3CD+MACW880	251	305,5	2484,5	1089,5	1395	235	191	G6"	205
E10PX200/3BC+MACW890	251	315,5	2519,5	1089,5	1430	235	191	G6"	205
E10PX200/4BC+MACW8125	251	377,5	2949,5	1264,5	1685	235	191	G6"	205
E10PX200/4BC+MACW10125A	254	450,5	2800,5	1264,5	1536	235	242	G6"	173
E10PX200/4A+MACW8150	251	397	3024,5	1264,5	1760	235	191	G6"	205
E10PX200/4A+MACW10150A	254	487	2905,5	1264,5	1641	235	242	G6"	173
E10PX200/4D+MACW890	251	330,5	2694,5	1264,5	1430	235	191	G6"	205

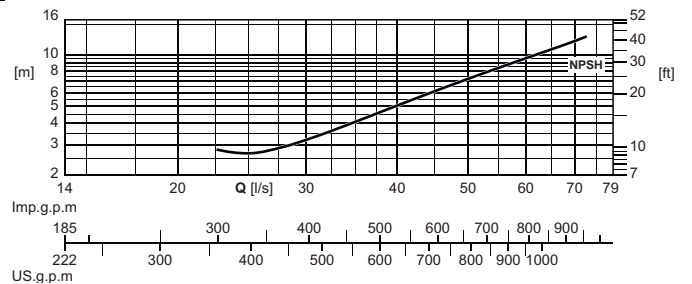
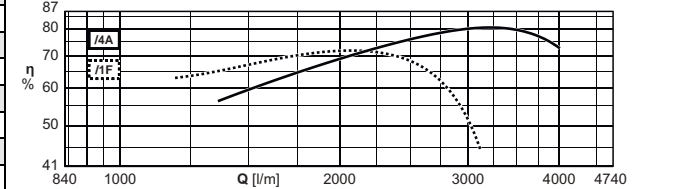
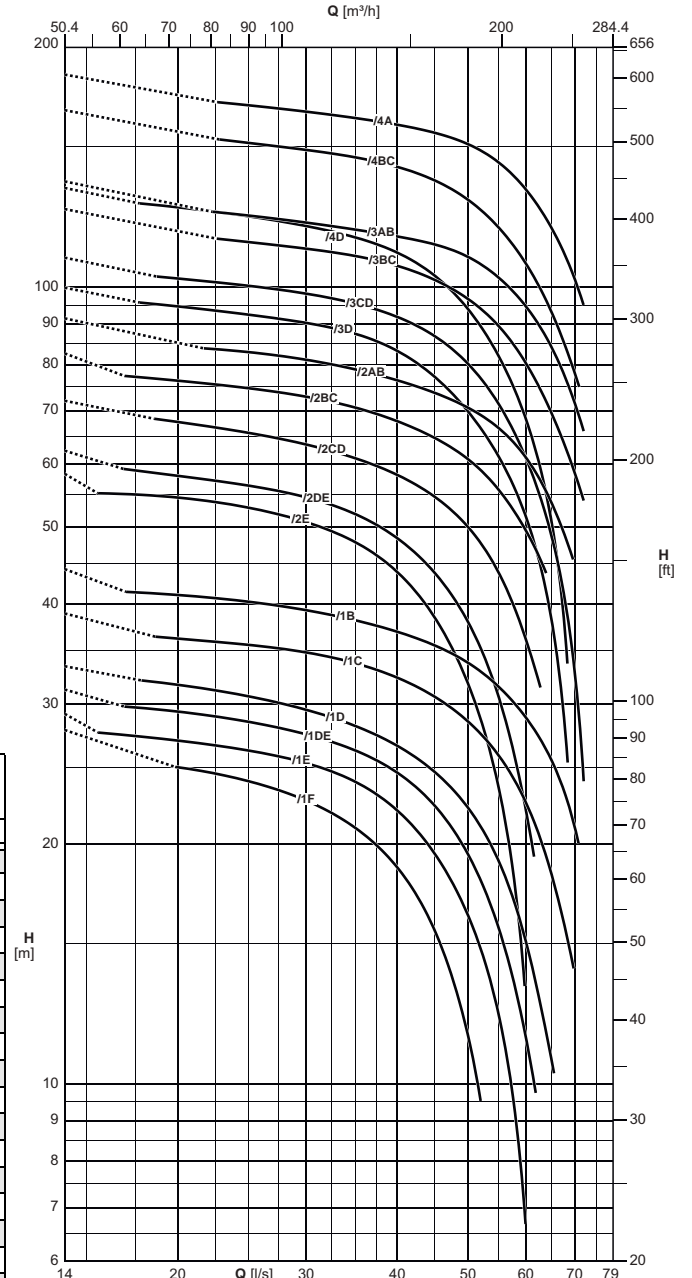

The hydraulic performance characteristics are guaranteed as conforming to standard UNI/ISO 9906 Grade 3B.
Available with NPT thread.

Les caractéristiques hydrauliques de fonctionnement sont garanties conformes à la norme UNI/ISO 9906 Niveau 3B.
Disponible avec filetage NPT.

Le caratteristiche di funzionamento vengono garantite secondo la norma: UNI/ISO 9906 Grado 3B.
Disponibile con filettatura NPT.

Operating data
Caracteristiques de fonctionnement
Caratteristiche di funzionamento

Electric pump type Electropompe type Elettropompa tipo	Motor power Puiss. moteur Potenza motore		Horizontal installation Installation horizontale Installazione orizzontale	Check valve \varnothing Clapet de retenue \varnothing Valvola di ritegno \varnothing	Capacity Debit Portata												
					[l/s]	0	20	25	30	35	40	45	50	55	60	65	70
	[l/min]	0			1200	1500	1800	2100	2400	2700	3000	3300	3600	3900	4200		
	[m ³ /h]	0			72	90	108	126	144	162	180	198	216	234	252		
[kW]	[HP]	Head Hauteur Prevalenza															
E10PX200/1F+MACW615A	11	15	<input type="checkbox"/>	6" Gas	[m]	28	25	24	22,5	21	18,5	15,5	11,5	-	-	-	-
E10PX200/1E+MACW617A	13	17,5	<input type="checkbox"/>	6" Gas	[m]	29	27	26	25,5	24	22	19,5	16,5	12,5	-	-	-
E10PX200/1DE+MACW620A	15	20	<input type="checkbox"/>	6" Gas	[m]	31,5	29,5	28,5	27,5	26	24,5	22,5	19,5	16	11,5	-	-
E10PX200/1D+MACW625A	18,5	25	<input type="checkbox"/>	6" Gas	[m]	33,5	31,5	30,5	29,5	28	26,5	24,5	22	19	15	11	-
E10PX200/1C+MACW630A	22	30	<input type="checkbox"/>	6" Gas	[m]	39	36	35,5	35	34	32,5	30,5	28,5	26	22,5	18,5	-
E10PX200/1B+MACW635A	26	35	<input type="checkbox"/>	6" Gas	[m]	44,5	41	40,5	39,5	38	37	35,5	34	31,5	29	25,5	21
E10PX200/2E+MACW635A	26	35	<input type="checkbox"/>	6" Gas	[m]	58	54	53	51	48	44	38,5	32	23,5	-	-	-
E10PX200/2DE+MACW640A	30	40	<input type="checkbox"/>	6" Gas	[m]	62	58	56	54	52	48,5	44	38	30,5	22	-	-
E10PX200/2DE+MACW840	30	40	<input type="checkbox"/>	6" Gas	[m]	63	59	57	55	53	49,5	45	39	32	23,5	-	-
E10PX200/2CD+MACW650B	37	50	<input type="checkbox"/>	6" Gas	[m]	72	68	66	63	61	58	55	50	44	36	-	-
E10PX200/2CD+MACW850	37	50	<input type="checkbox"/>	6" Gas	[m]	73	69	67	66	63	60	56	52	46	38,5	-	-
E10PX200/2BC+MACW660B	45	60	<input type="checkbox"/>	6" Gas	[m]	82	76	75	73	70	68	65	61	56	49,5	-	-
E10PX200/2BC+MACW860	45	60	<input type="checkbox"/>	6" Gas	[m]	84	78	76	74	72	70	67	63	58	52	-	-
E10PX200/2AB+MACW870	51	70	<input type="checkbox"/>	6" Gas	[m]	91	-	83	81	79	76	74	70	66	61	54	-
E10PX200/3AB+MACW8100	75	100	<input type="checkbox"/>	6" Gas	[m]	136	-	123	120	118	116	113	109	103	94	84	71
E10PX200/3AB+MACW10100A	75	100	<input type="checkbox"/>	6" Gas	[m]	137	-	125	122	120	118	115	111	105	97	87	75
E10PX200/3D+MACW870	51	70	<input type="checkbox"/>	6" Gas	[m]	100	94	92	90	87	83	77	70	61	51	38	-
E10PX200/3CD+MACW880	59	80	<input type="checkbox"/>	6" Gas	[m]	109	102	100	98	95	92	87	80	71	61	49	32,5
E10PX200/3BC+MACW890	66	90	<input type="checkbox"/>	6" Gas	[m]	125	-	114	112	109	106	102	96	89	80	69	58
E10PX200/4BC+MACW8125	92	125	<input type="checkbox"/>	6" Gas	[m]	167	-	152	149	145	141	136	129	119	107	93	78
E10PX200/4BC+MACW10125A	92	125	<input type="checkbox"/>	6" Gas	[m]	168	-	153	150	147	143	138	131	121	110	96	82
E10PX200/4A+MACW8150	110	150	<input type="checkbox"/>	6" Gas	[m]	185	-	169	166	163	160	156	151	143	132	119	102
E10PX200/4A+MACW10150A	110	150	<input type="checkbox"/>	6" Gas	[m]	186	-	171	167	165	162	158	154	147	137	124	107
E10PX200/4D+MACW890	66	90	<input type="checkbox"/>	6" Gas	[m]	133	126	123	119	115	110	103	94	82	68	51	-
NPSH					[m]	-	3	2,6	3,5	3,8	5,1	5,9	7,1	7,9	9,4	10,5	12

■ Without conical valve

On request

Please contact our sales organisation

For motor performances specification see page "motor features"

Temperature monitoring device for submersed electric motors 6" ÷ 14": see page "Accessories"

■ Sans soupape du clapet.

Sur demande

Contacter notre service commercial.

Pour caracteristiques techniques moteurs voir page "Caracteristiques des moteurs"

Appareillage de contrôle de la température des moteurs électriques immergés 6" ÷ 14": voir page "Accessories"

■ Senza clapet valvola di ritegno

Su richiesta

Interpellare la sede o la rete di vendita

Per caratteristiche motori vedere pagina "caratteristiche motori"

Apparecchiatura di controllo temperatura motori elettrici sommersi 6" ÷ 14": vedere pagina accessori

Operating data
Caracteristiques de fonctionnement
Caratteristiche di funzionamento

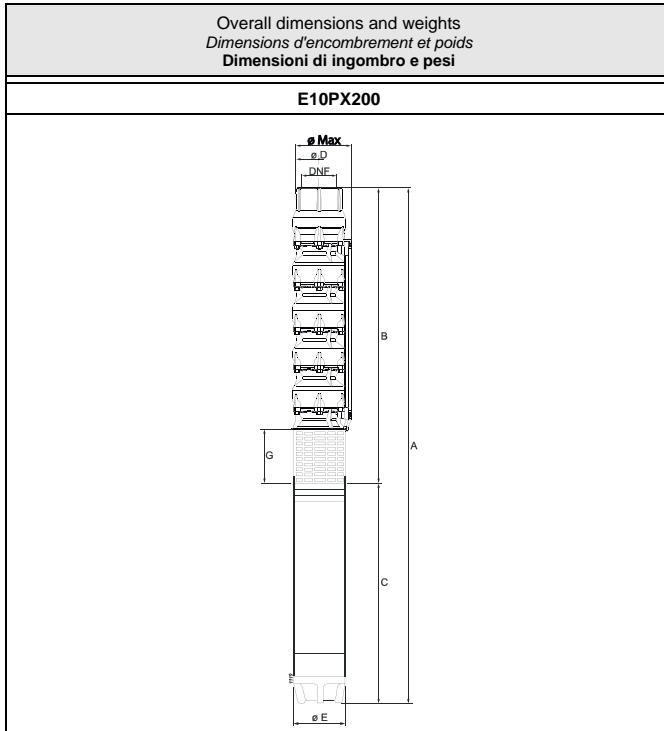

Type Type Tipo	Ø max [mm]	Weight Poids Peso [kg]	A	B	C	D	E	F	G
			[mm]						
E10PX200/5CD+MACW8125	251	393	3124,5	1439,5	1685	235	191	G6"	205
E10PX200/5CD+MACW10125A	254	466	2975,5	1439,5	1536	235	242	G6"	173
E10PX200/5AB+MACW10180A	254	538	3205,5	1439,5	1766	235	242	G6"	173
E10PX200/6CD+MACW8150	251	427	3374,5	1614,5	1760	235	191	G6"	205
E10PX200/6CD+MACW10150A	254	517	3255,5	1614,5	1641	235	242	G6"	173
E10PX200/6BC+MACW10180A	254	553	3380,5	1614,5	1766	235	242	G6"	173
E10PX200/6B+MACW10200A	254	580,5	3480,5	1614,5	1866	235	242	G6"	173
E10PX200/7C+MACW10200A	254	596	3655,5	1789,5	1866	235	242	G6"	173
E10PX200/7AB+MACW10250A	259	662	3915,5	1789,5	2126	235	242	G6"	173
E10PX200/8C+MACW10220A	259	642	3990,5	1964,5	2026	235	242	G6"	173
E10PX200/8C+MACW12230A	290	881,5	4043	2085	1958	235	290	G6"	237
E10PX200/8B+MACW10250A	259	675,5	4090,5	1964,5	2126	235	242	G6"	173
E10PX200/8A+MACW12300C	290	884,5	4043	2085	1958	235	290	G6"	237
E10PX200/8A+MW14300	340	1005,5	4012	2085	1927	235	337	G6"	237
E10PX200/9C+MACW12260A	290	965,5	4368	2260	2108	235	290	G6"	237
E10PX200/9A+MW14330	340	1052	4242	2260	1982	235	337	G6"	237
E10PX200/9A+MACW12340C	290	969	4368	2260	2108	235	290	G6"	237
E10PX200/10A+MW14380	340	1108	4477	2435	2042	235	337	G6"	237
E10PX200/11B+MW14380	340	1124,5	4652	2610	2042	235	337	G6"	237
E10PX200/11A+MACW12400C	290	1055,5	4868	2610	2258	235	290	G6"	237
E10PX200/12JD+MW14330	340	1096,5	4767	2785	1982	235	337	G6"	237
E10PX200/13D+MACW12300C	290	960	4918	2960	1958	235	290	G6"	237
E10PX200/13D+MW14300	340	1081	4887	2960	1927	235	337	G6"	237
E10PX200/14D+MACW12340C	290	1044	5243	3135	2108	235	290	G6"	237

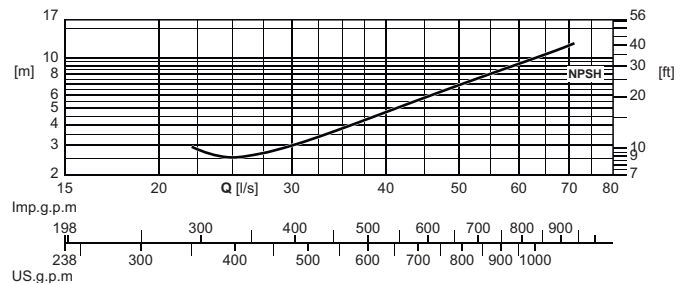
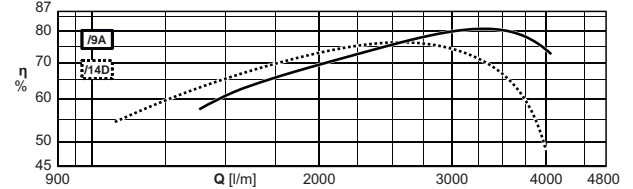
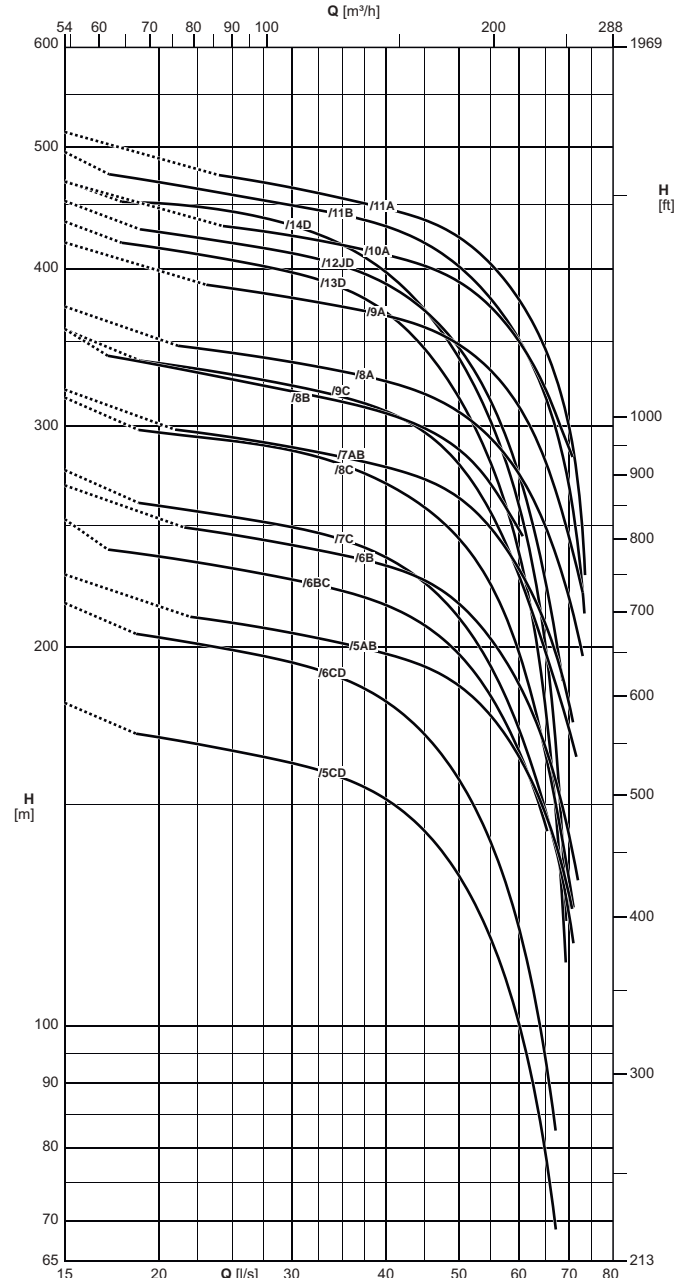

The hydraulic performance characteristics are guaranteed as conforming to standard UNI/ISO 9906 Grade 3B.
Available with NPT thread.

Les caractéristiques hydrauliques de fonctionnement sont garanties conformes à la norme UNI/ISO 9906 Niveau 3B.
Disponible avec filetage NPT.

Le caratteristiche di funzionamento vengono garantite secondo la norma: UNI/ISO 9906 Grado 3B.
Disponibile con filettatura NPT.

Operating data
Caracteristiques de fonctionnement
Caratteristiche di funzionamento

Electric pump type Electropompe type Elettropompa tipo	Motor power Puiss. moteur Potenza motore		Horizontal installation Installation horizontale Installazione orizzontale	Check valve \varnothing Clapet de retenue \varnothing Valvola di ritegno \varnothing	Capacity Debit Portata												
					[l/s]	0	20	25	30	35	40	45	50	55	60	65	70
	[l/min]	0			1200	1500	1800	2100	2400	2700	3000	3300	3600	3900	4200		
	[m ³ /h]	0			72	90	108	126	144	162	180	198	216	234	252		
[kW]	[HP]	Head Hauteur Prevalenza															
E10PX200/5CD+MACW8125	92	125	○	6" Gas	[m]	180	169	165	162	157	151	143	131	117	100	79	-
E10PX200/5CD+MACW10125A	92	125	□	6" Gas	[m]	182	172	169	165	160	154	146	135	121	103	83	-
E10PX200/5AB+MACW10180A	132	180	□	6" Gas	[m]	228	-	209	205	201	197	193	186	177	164	148	126
E10PX200/6CD+MACW8150	110	150	○	6" Gas	[m]	217	204	199	194	189	181	170	157	140	120	94	-
E10PX200/6CD+MACW10150A	110	150	□	6" Gas	[m]	219	203	201	198	193	185	175	162	145	125	100	-
E10PX200/6BC+MACW10180A	132	180	□	6" Gas	[m]	253	236	231	226	222	216	208	197	183	165	144	-
E10PX200/6B+MACW10200A	150	200	○	6" Gas	[m]	269	-	246	241	237	232	226	216	203	187	166	141
E10PX200/7C+MACW10200A	150	200	○	6" Gas	[m]	277	259	254	249	243	236	225	211	193	172	149	122
E10PX200/7AB+MACW10250A	185	250	○	6" Gas	[m]	321	-	294	288	283	278	272	263	249	231	209	180
E10PX200/8C+MACW10220A	160	220	○	6" Gas	[m]	316	296	292	287	279	270	258	244	224	198	165	130
E10PX200/8C+MACW12230A	170	230	□	6" Gas	[m]	318	299	293	287	281	273	263	248	227	202	172	136
E10PX200/8B+MACW10250A	185	250	○	6" Gas	[m]	358	335	327	320	314	307	299	287	270	248	-	-
E10PX200/8A+MACW12300C	220	300	□	6" Gas	[m]	373	-	343	337	331	325	318	307	293	275	250	218
E10PX200/8A+MW14300	220	300	○	6" Gas	[m]	375	-	346	340	334	328	322	313	300	281	255	224
E10PX200/9C+MACW12260A	190	260	□	6" Gas	[m]	358	337	330	323	316	308	296	279	256	228	199	172
E10PX200/9A+MW14330	240	330	○	6" Gas	[m]	422	-	389	382	376	369	362	353	338	318	288	250
E10PX200/9A+MACW12340C	250	340	□	6" Gas	[m]	420	-	386	379	373	367	359	348	332	311	282	244
E10PX200/10A+MW14380	280	380	○	6" Gas	[m]	469	-	432	425	418	410	402	390	373	350	321	288
E10PX200/11B+MW14380	280	380	○	6" Gas	[m]	495	469	458	449	442	432	419	402	379	351	316	267
E10PX200/11A+MACW12400C	295	400	○	6" Gas	[m]	514	-	473	464	455	447	437	424	404	378	345	297
E10PX200/12JD+MW14330	240	330	○	6" Gas	[m]	453	428	419	411	402	389	370	346	314	274	226	-
E10PX200/13D+MACW12300C	220	300	○	6" Gas	[m]	436	415	406	397	386	369	345	316	280	237	179	-
E10PX200/13D+MW14300	220	300	○	6" Gas	[m]	439	420	412	402	390	374	352	322	283	-	-	-
E10PX200/14D+MACW12340C	250	340	○	6" Gas	[m]	470	451	444	433	418	397	371	339	303	259	200	-
NPSH					[m]	-	3	2,6	3,5	3,8	5,1	5,9	7,1	7,9	9,4	10,5	12

■ Without conical valve

□ On request

○ Please contact our sales organisation

For motor performances specification see page "motor features"

Temperature monitoring device for submersed electric motors 6" ÷ 14": see page "Accessories"

■ Sans soupape du clapet.

□ Sur demande

○ Contacter notre service commercial.

Pour caractéristiques techniques moteurs voir page "Caractéristiques des moteurs"

Appareillage de contrôle de la température des moteurs électriques immergés 6" ÷ 14": voir page "Accessories"

■ Senza clapet valvola di ritegno

□ Su richiesta

○ Interpellare la sede o la rete di vendita

Per caratteristiche motori vedere pagina "caratteristiche motori"

Apparecchiatura di controllo temperatura motori elettrici sommersi 6" ÷ 14": vedere pagina accessori

Operating data
Caracteristiques de fonctionnement
Caratteristiche di funzionamento

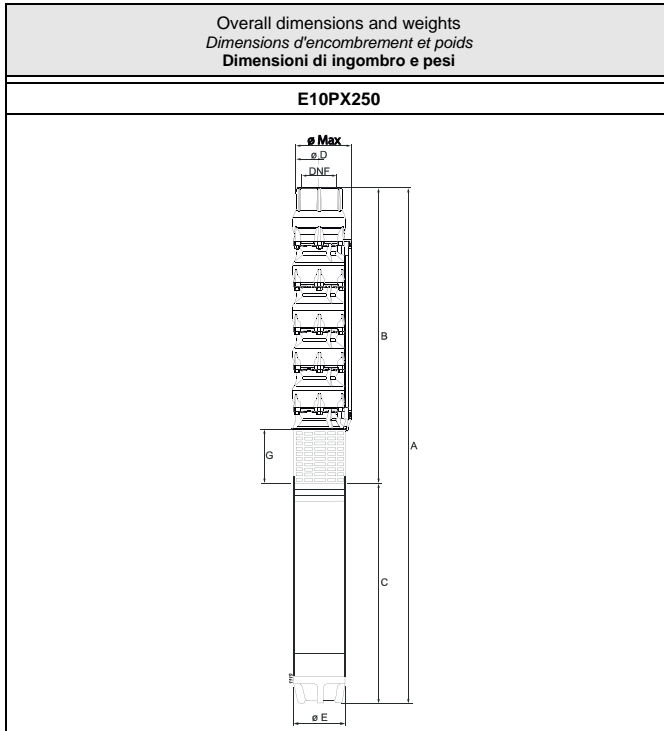

Type Type Tipo	Ø max [mm]	Weight Poids Peso [kg]	A	B	C	D	E	F	G
			[mm]						
E10PX250/1I+MACW617A	250.5	118	1464	714	750	235	143	G6"	173
E10PX250/1H+MACW620A	250.5	121,8	1504	714	790	235	143	G6"	173
E10PX250/1F+MACW625A	250.5	126,7	1544	714	830	235	143	G6"	173
E10PX250/1DE+MACW630A	250.5	137	1634	714	920	235	143	G6"	173
E10PX250/1C+MACW635A	250.5	152,3	1769	714	1055	235	143	G6"	173
E10PX250/1A+MACW640A	250.5	164,9	1879	714	1165	235	143	G6"	173
E10PX250/1A+MACW840	251	206	1799,5	739,5	1060	235	191	G6"	205
E10PX250/2HI+MACW635A	250.5	166,8	1944	889	1055	235	143	G6"	173
E10PX250/2H+MACW640A	250.5	179,4	2054	889	1165	235	143	G6"	173
E10PX250/2H+MACW840	251	220,5	1974,5	914,5	1060	235	191	G6"	205
E10PX250/2G+MACW650B	250.5	196,5	2171	889	1282	235	143	G6"	173
E10PX250/2G+MACW850	251	232,5	2029,5	914,5	1115	235	191	G6"	205
E10PX250/2F+MACW650B	250.5	198	2171	889	1282	235	143	G6"	173
E10PX250/2F+MACW850	251	234	2029,5	914,5	1115	235	191	G6"	205
E10PX250/2DE+MACW660B	250.5	202,8	2211	889	1322	235	143	G6"	173
E10PX250/2DE+MACW860	251	251,5	2109,5	914,5	1195	235	191	G6"	205
E10PX250/2C+MACW870	251	271,8	2204,5	914,5	1290	235	191	G6"	205
E10PX250/2A+MACW880	251	290	2309,5	914,5	1395	235	191	G6"	205
E10PX250/3C+MACW8100	251	331,5	2589,5	1089,5	1500	235	191	G6"	205
E10PX250/3C+MACW10100A	254	396,5	2495,5	1089,5	1406	235	242	G6"	173
E10PX250/3A+MACW8125	251	362	2774,5	1089,5	1685	235	191	G6"	205
E10PX250/3A+MACW10125A	254	435	2625,5	1089,5	1536	235	242	G6"	173
E10PX250/3EF+MACW880	251	305,5	2484,5	1089,5	1395	235	191	G6"	205
E10PX250/3JE+MACW890	251	315	2519,5	1089,5	1430	235	191	G6"	205

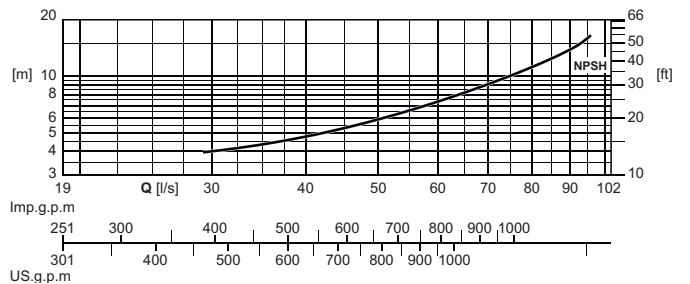
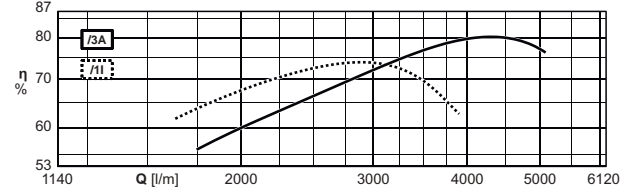
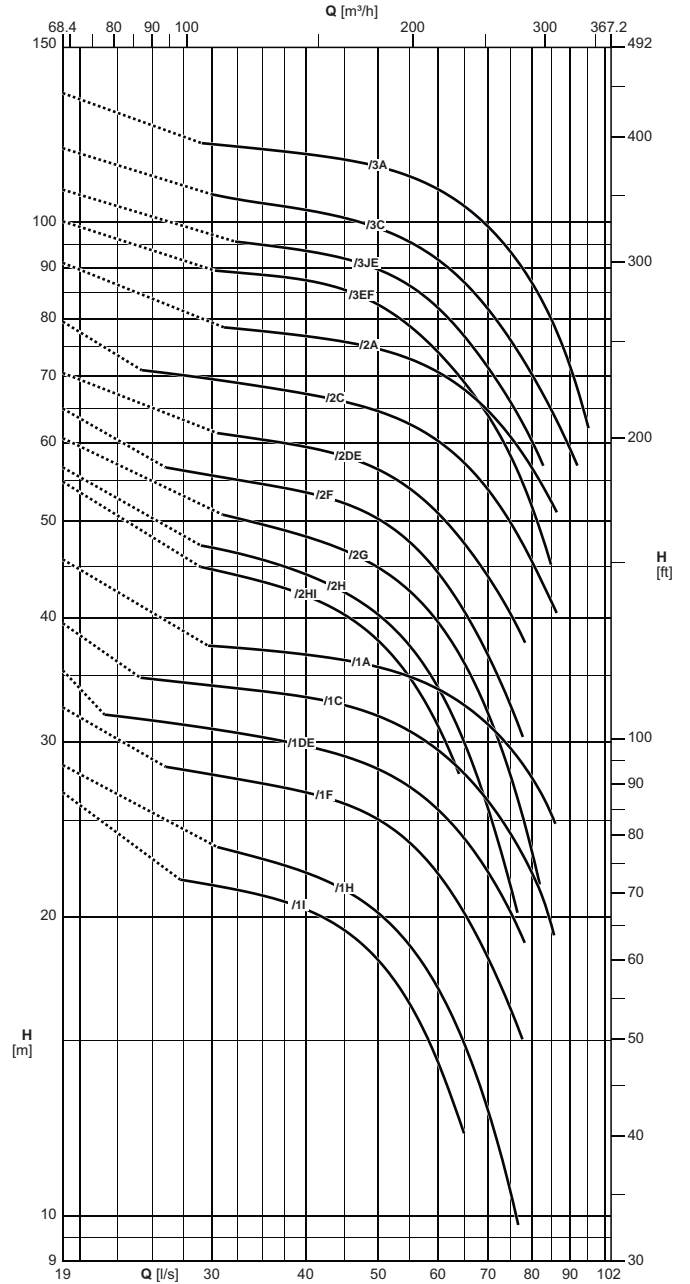

The hydraulic performance characteristics are guaranteed as conforming to standard UNI/ISO 9906 Grade 3B.
Available with NPT thread.

Les caractéristiques hydrauliques de fonctionnement sont garanties conformes à la norme UNI/ISO 9906 Niveau 3B.
Disponible avec filetage NPT.

Le caratteristiche di funzionamento vengono garantite secondo la norma: UNI/ISO 9906 Grado 3B.
Disponibile con filettatura NPT.

Operating data
Caracteristiques de fonctionnement
Caratteristiche di funzionamento

Electric pump type Electropompe type Elettropompa tipo	Motor power Puiss. moteur Potenza motore		Horizontal installation Installation horizontale Installazione orizzontale	Check valve \varnothing Clapet de retenue \varnothing Valvola di ritegno \varnothing	Capacity Debit Portata																	
					[l/s]	0	25	30	35	40	45	50	55	60	65	70	75	80	85	90	95	
	[l/min]	0			1500	1800	2100	2400	2700	3000	3300	3600	3900	4200	4500	4800	5100	5400	5700			
	[m ³ /h]	0			90	108	126	144	162	180	198	216	234	252	270	288	306	324	342			
[kW]	[HP]	Head Hauteur Prevalenza																				
E10PX250/1I+MACW617A	13	17,5	<input type="checkbox"/>	6" Gas	[m]	26,5	-	21,5	21	20,5	19,5	18	16,5	14,5	12	-	-	-	-	-	-	-
E10PX250/1H+MACW620A	15	20	<input type="checkbox"/>	6" Gas	[m]	28,5	-	-	23	22	21,5	20	18,5	17	15	12,5	10,5	-	-	-	-	-
E10PX250/1F+MACW625A	18,5	25	<input type="checkbox"/>	6" Gas	[m]	32,5	-	28	27	26,5	26	25	23,5	22	20	18	16	-	-	-	-	-
E10PX250/1DE+MACW630A	22	30	<input type="checkbox"/>	6" Gas	[m]	35,5	31,5	31	30,5	29,5	29	28	27	25,5	24	22	20	-	-	-	-	-
E10PX250/1C+MACW635A	26	35	<input type="checkbox"/>	6" Gas	[m]	39,5	34,5	34	33,5	33,5	32,5	32	30,5	29,5	28	26	24	22	19,5	-	-	-
E10PX250/1A+MACW640A	30	40	<input type="checkbox"/>	6" Gas	[m]	46	-	37,5	37	36,5	36	35,5	35	34	32,5	31	29,5	27,5	25,5	-	-	-
E10PX250/1A+MACW840	30	40	<input type="checkbox"/>	6" Gas	[m]	46	-	38	37,5	37,5	37	36,5	35,5	34,5	33,5	32	30,5	28,5	26	-	-	-
E10PX250/2HI+MACW635A	26	35	<input type="checkbox"/>	6" Gas	[m]	55	-	44,5	43,5	42	40,5	38	35	31	-	-	-	-	-	-	-	-
E10PX250/2H+MACW640A	30	40	<input type="checkbox"/>	6" Gas	[m]	57	-	47	45,5	44	42,5	40	37,5	34	30	25,5	21,5	-	-	-	-	-
E10PX250/2H+MACW840	30	40	<input type="checkbox"/>	6" Gas	[m]	57	-	47,5	46,5	45	43,5	41	38,5	35	31	26,5	22,5	-	-	-	-	-
E10PX250/2G+MACW650B	37	50	<input type="checkbox"/>	6" Gas	[m]	61	-	-	49,5	48,5	46,5	45	42,5	39,5	36	32	27,5	23,5	-	-	-	-
E10PX250/2G+MACW850	37	50	<input type="checkbox"/>	6" Gas	[m]	61	-	-	50	49	47,5	46	43,5	40,5	37	33	28,5	24,5	-	-	-	-
E10PX250/2F+MACW650B	37	50	<input type="checkbox"/>	6" Gas	[m]	65	-	56	54	53	52	50	47,5	44,5	40,5	36,5	32,5	-	-	-	-	-
E10PX250/2F+MACW850	37	50	<input type="checkbox"/>	6" Gas	[m]	66	-	56	55	54	53	51	49	45,5	42	38	34	-	-	-	-	-
E10PX250/2DE+MACW660B	45	60	<input type="checkbox"/>	6" Gas	[m]	70	-	-	60	59	58	56	54	51	47,5	44	40,5	-	-	-	-	-
E10PX250/2DE+MACW860	45	60	<input type="checkbox"/>	6" Gas	[m]	71	64	63	62	61	60	58	56	53	49,5	46	42,5	-	-	-	-	-
E10PX250/2C+MACW870	51	70	<input type="checkbox"/>	6" Gas	[m]	79	71	69	68	67	66	64	63	60	57	54	50	45,5	41,5	-	-	-
E10PX250/2A+MACW880	59	80	<input type="checkbox"/>	6" Gas	[m]	91	-	-	78	77	76	74	73	71	68	64	61	57	52	-	-	-
E10PX250/3C+MACW8100	75	100	<input type="checkbox"/>	6" Gas	[m]	119	-	107	104	103	101	98	95	92	87	82	76	70	65	59	-	-
E10PX250/3C+MACW10100A	75	100	<input type="checkbox"/>	6" Gas	[m]	120	-	108	105	104	102	100	97	94	89	84	78	72	66	-	-	-
E10PX250/3A+MACW8125	92	125	<input type="checkbox"/>	6" Gas	[m]	135	-	120	118	117	116	114	111	108	104	99	93	87	80	71	62	-
E10PX250/3A+MACW10125A	92	125	<input type="checkbox"/>	6" Gas	[m]	136	-	121	119	118	116	115	112	109	105	101	96	89	82	73	64	-
E10PX250/3EF+MACW880	59	80	<input type="checkbox"/>	6" Gas	[m]	100	-	-	88	87	85	82	78	74	69	64	58	52	-	-	-	-
E10PX250/3JE+MACW890	66	90	<input type="checkbox"/>	6" Gas	[m]	108	-	-	95	93	92	89	86	82	77	71	66	60	-	-	-	-
NPSH					[m]	-	4,7	5,2	5,4	5,5	6,1	6,3	7,3	8,2	9,2	9,8	10	12	13,5	14,5	16	-

■ Without conical valve

On request

Please contact our sales organisation

For motor performances specification see page "motor features"

Temperature monitoring device for submersed electric motors 6" ÷ 14": see page "Accessories"

■ Sans soupape du clapet.

Sur demande

Contacter notre service commercial.

Pour caractéristiques techniques moteurs voir page "Caractéristiques des moteurs"

Appareillage de contrôle de la température des moteurs électriques immergés 6" ÷ 14": voir page "Accessories"

■ Senza clapet valvola di ritegno

Su richiesta

Interpellare la sede o la rete di vendita

Per caratteristiche motori vedere pagina "caratteristiche motori"

Apparecchiatura di controllo temperatura motori elettrici sommersi 6" ÷ 14": vedere pagina accessori

Operating data
Caracteristiques de fonctionnement
Caratteristiche di funzionamento

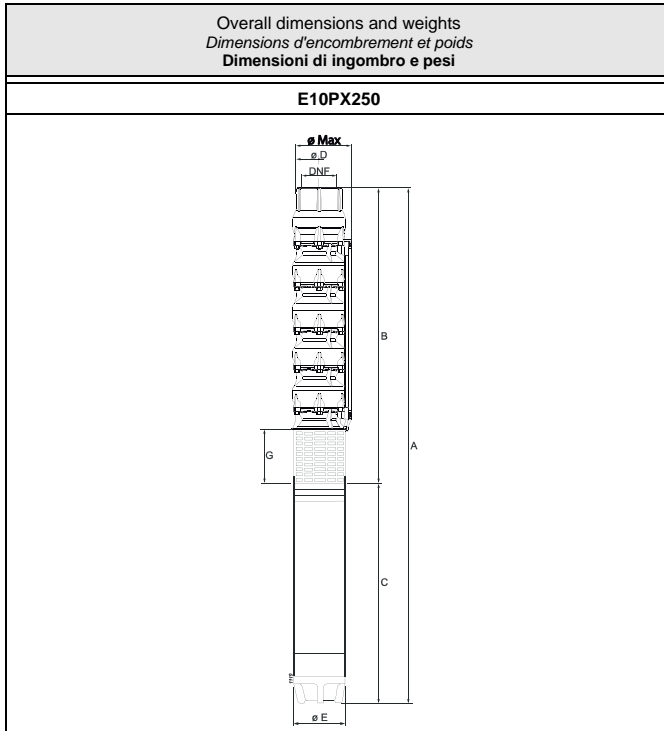

Type Type Tipo	ø max [mm]	Weight Poids Peso [kg]	A	B	C	D	E	F	G
E10PX250/4EF+MACW8100	251	347	2764,5	1264,5	1500	235	191	G6"	205
E10PX250/4EF+MACW10100A	254	412	2670,5	1264,5	1406	235	242	G6"	173
E10PX250/4D+MACW8125	251	378	2949,5	1264,5	1685	235	191	G6"	205
E10PX250/4D+MACW10125A	254	451	2800,5	1264,5	1536	235	242	G6"	173
E10PX250/4M+MACW8150	251	397	3024,5	1264,5	1760	235	191	G6"	205
E10PX250/4M+MACW10150A	254	487	2905,5	1264,5	1641	235	242	G6"	173
E10PX250/5JE+MACW8150	251	410	3199,5	1439,5	1760	235	191	G6"	205
E10PX250/5JE+MACW10150A	254	500	3080,5	1439,5	1641	235	242	G6"	173
E10PX250/5BC+MACW10180A	254	569,5	3205,5	1439,5	1766	235	242	G6"	173
E10PX250/5A+MACW10200A	254	567	3305,5	1439,5	1866	235	242	G6"	173
E10PX250/6QC+MACW10200A	254	584	3480,5	1614,5	1866	235	242	G6"	173
E10PX250/6S+MACW10220A	259	614	3640,5	1614,5	2026	235	242	G6"	173
E10PX250/6MN+MACW12230A	290	852	3693	1735	1958	235	290	G6"	237
E10PX250/6A+MACW10250A	259	647	3740,5	1614,5	2126	235	242	G6"	173
E10PX250/7V+MACW12260A	290	937	4018	1910	2108	235	290	G6"	237
E10PX250/8B+MACW12300C	290	886	4043	2085	1958	235	290	G6"	237
E10PX250/8B+MW14300	340	1007	4012	2085	1927	235	337	G6"	237
E10PX250/8N+MW14330	340	1037	4067	2085	1982	235	337	G6"	237
E10PX250/9B+MACW12340C	290	971	4368	2260	2108	235	290	G6"	237
E10PX250/10B+MW14380	340	1110	4477	2435	2042	235	337	G6"	237
E10PX250/10A+MACW12400C	290	1041	4693	2435	2258	235	290	G6"	237

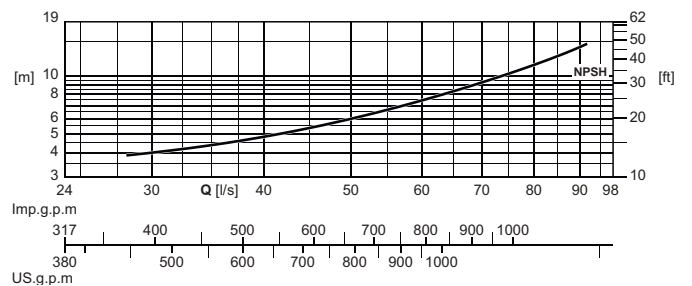
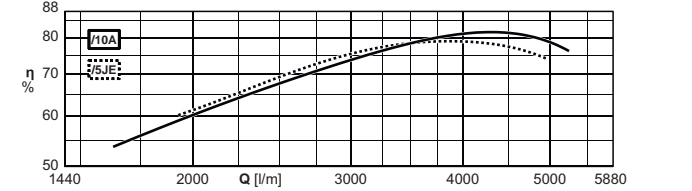
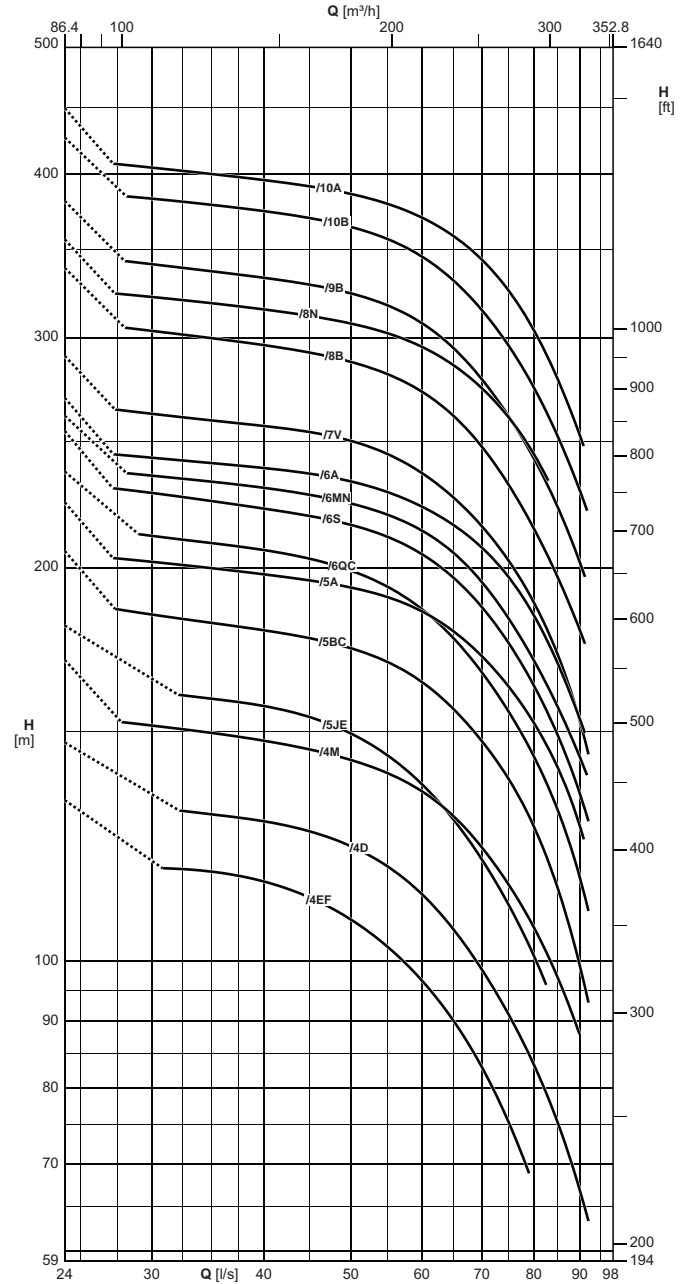

The hydraulic performance characteristics are guaranteed as conforming to standard UNI/ISO 9906 Grade 3B.
Available with NPT thread.

Les caractéristiques hydrauliques de fonctionnement sont garanties conformes à la norme UNI/ISO 9906 Niveau 3B.
Disponible avec filetage NPT.

Le caratteristiche di funzionamento vengono garantite secondo la norma: UNI/ISO 9906 Grado 3B.
Disponibile con filettatura NPT.

Operating data
Caracteristiques de fonctionnement
Caratteristiche di funzionamento

Electric pump type Electropompe type Elettropompa tipo	Motor power Puiiss. moteur Potenza motore		Horizontal installation Installation horizontale Installazione orizzontale	Check valve Ø Clapet de retenue Ø Valvola di ritegno Ø	Capacity Debit Portata														
					[l/s]	0	30	35	40	45	50	55	60	65	70	75	80	85	90
	[l/min]	0			1800	2100	2400	2700	3000	3300	3600	3900	4200	4500	4800	5100	5400		
	[m³/h]	0			108	126	144	162	180	198	216	234	252	270	288	306	324		
[kW]	[HP]	Head Hauteur Prevalenza																	
E10PX250/4EF+MACW8100	75	100	○	6" Gas	[m]	133	-	117	115	112	107	102	97	90	83	75	-	-	-
E10PX250/4EF+MACW10100A	75	100	□	6" Gas	[m]	134	-	118	117	114	110	105	99	92	85	77	-	-	-
E10PX250/4D+MACW8125	92	125	○	6" Gas	[m]	147	-	129	128	126	122	118	112	106	98	91	83	75	67
E10PX250/4D+MACW10125A	92	125	□	6" Gas	[m]	148	133	131	129	127	124	119	114	107	100	93	86	78	70
E10PX250/4M+MACW8150	110	150	○	6" Gas	[m]	170	151	149	147	145	142	139	135	129	122	114	106	97	-
E10PX250/4M+MACW10150A	110	150	□	6" Gas	[m]	172	154	152	151	149	146	143	139	133	126	118	110	100	90
E10PX250/5JE+MACW8150	110	150	○	6" Gas	[m]	180	-	159	157	154	149	143	136	128	119	110	101	-	-
E10PX250/5JE+MACW10150A	110	150	□	6" Gas	[m]	182	165	162	159	156	152	147	141	133	124	114	105	-	-
E10PX250/5BC+MACW10180A	132	180	□	6" Gas	[m]	206	184	181	179	176	173	169	163	156	147	138	127	114	99
E10PX250/5A+MACW10200A	150	200	○	6" Gas	[m]	224	202	200	198	195	193	190	185	179	171	162	152	141	127
E10PX250/6QC+MACW10200A	150	200	○	6" Gas	[m]	237	211	209	206	203	199	193	186	177	166	155	143	131	116
E10PX250/6S+MACW10220A	160	220	○	6" Gas	[m]	254	228	225	222	219	215	211	205	196	186	175	162	149	134
E10PX250/6MN+MACW12230A	170	230	□	6" Gas	[m]	261	235	233	230	227	224	219	213	205	195	183	170	156	143
E10PX250/6A+MACW10250A	185	250	○	6" Gas	[m]	270	243	240	238	236	233	228	222	216	207	196	184	169	153
E10PX250/7V+MACW12260A	190	260	□	6" Gas	[m]	290	262	259	257	254	250	244	236	226	215	202	188	172	152
E10PX250/8B+MACW12300C	220	300	○	6" Gas	[m]	339	304	300	296	292	287	281	273	261	247	231	214	196	179
E10PX250/8B+MW14300	220	300	○	6" Gas	[m]	341	306	302	298	295	291	285	277	265	250	234	217	201	185
E10PX250/8N+MW14330	240	330	○	6" Gas	[m]	356	322	319	315	312	307	302	295	286	274	260	244	-	-
E10PX250/9B+MACW12340C	250	340	○	6" Gas	[m]	381	341	337	333	329	324	317	308	295	278	261	242	222	202
E10PX250/10B+MW14380	280	380	○	6" Gas	[m]	426	383	379	375	370	364	357	346	332	315	296	275	252	229
E10PX250/10A+MACW12400C	295	400	○	6" Gas	[m]	449	405	400	396	391	386	379	370	359	344	325	304	279	252
NPSH					[m]	-	5,2	5,4	5,5	6,1	6,3	7,3	8,2	9,2	9,8	10	12	13,5	14,5

■ Without conical valve

□ On request

○ Please contact our sales organisation

For motor performances specification see page "motor features"

Temperature monitoring device for submersed electric motors 6" ÷ 14": see page "Accessories"

■ Sans soupape du clapet.

□ Sur demande

○ Contacter notre service commercial.

Pour caractéristiques techniques moteurs voir page "Caractéristiques des moteurs"

Appareillage de contrôle de la température des moteurs électriques immergés 6" ÷ 14": voir page "Accessories"

■ Senza clapet valvola di ritegno

□ Su richiesta

○ Interpellare la sede o la rete di vendita

Per caratteristiche motori vedere pagina "caratteristiche motori"

Apparecchiatura di controllo temperatura motori elettrici sommersi 6" ÷ 14": vedere pagina accessori

Operating data
 Caracteristiques de fonctionnement
 Caratteristiche di funzionamento

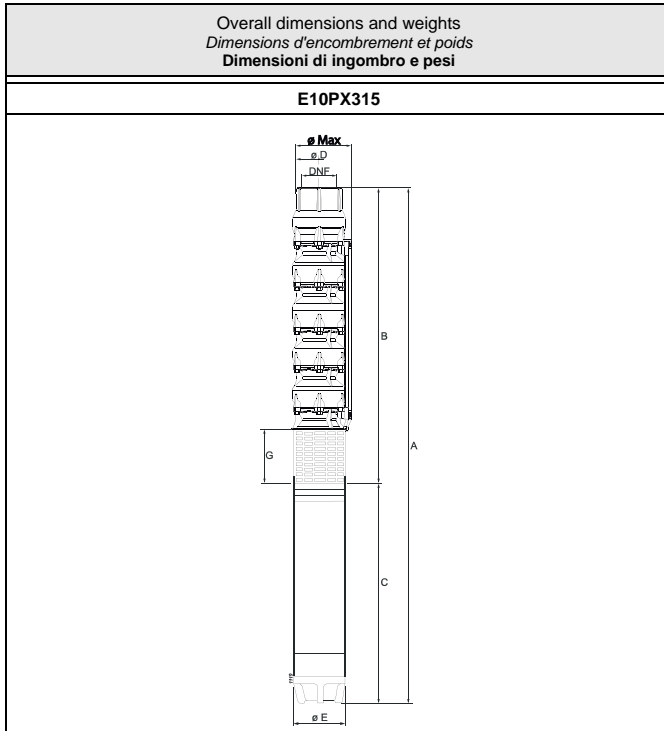

Type Type Tipo	ø max [mm]	Weight Poids Peso [kg]	A	B	C	D	E	F	G
			[mm]						
E10PX315/1CD+MACW635A	250.5	152,3	1769	714	1055	235	143	G6"	173
E10PX315/1BC+MACW640A	250.5	164,9	1879	714	1165	235	143	G6"	173
E10PX315/1BC+MACW840	251	206	1799,5	739,5	1060	235	191	G6"	205
E10PX315/1AB+MACW650B	250.5	182	1996	714	1282	235	143	G6"	173
E10PX315/1AB+MACW850	251	218	1854,5	739,5	1115	235	191	G6"	205
E10PX315/2A+MACW8100	251	315	2414,5	914,5	1500	235	191	G6"	205
E10PX315/2A+MACW10100A	254	380	2320,5	914,5	1406	235	242	G6"	173
E10PX315/2DE+MACW660B	250.5	185,8	2211	889	1322	235	143	G6"	173
E10PX315/2DE+MACW860	251	251	2109,5	914,5	1195	235	191	G6"	205
E10PX315/2CD+MACW870	251	271,5	2204,5	914,5	1290	235	191	G6"	205
E10PX315/2BC+MACW880	251	289,5	2309,5	914,5	1395	235	191	G6"	205
E10PX315/2B+MACW890	251	299	2344,5	914,5	1430	235	191	G6"	205
E10PX315/3W+MACW8125	251	361	2774,5	1089,5	1685	235	191	G6"	205
E10PX315/3W+MACW10125A	254	434	2625,5	1089,5	1536	235	242	G6"	173
E10PX315/3A+MACW8150	251	378	2849,5	1089,5	1760	235	191	G6"	205
E10PX315/3A+MACW10150A	254	468	2730,5	1089,5	1641	235	242	G6"	173
E10PX315/4B+MACW10180A	254	522	3030,5	1264,5	1766	235	242	G6"	173
E10PX315/4A+MACW10200A	254	546	3130,5	1264,5	1866	235	242	G6"	173
E10PX315/5B+MACW10220A	259	597	3465,5	1439,5	2026	235	242	G6"	173
E10PX315/5M+MACW12230A	290	834,5	3518	1560	1958	235	290	G6"	237
E10PX315/5I+MACW10250A	259	630	3565,5	1439,5	2126	235	242	G6"	173
E10PX315/5A+MACW12260A	290	902,5	3668	1560	2108	235	290	G6"	237
E10PX315/6I+MACW12300C	290	868,5	3868	1910	1958	235	290	G6"	237
E10PX315/6I+MW14300	340	989,5	3662	1735	1927	235	337	G6"	237
E10PX315/7X+MW14330	340	1019,5	3717	1735	1982	235	337	G6"	237
E10PX315/7X+MACW12340C	290	936,5	4018	1910	2108	235	290	G6"	237
E10PX315/7A+MW14380	340	1058,5	3777	1735	2042	235	337	G6"	237
E10PX315/8A+MACW12400C	290	1006,5	4343	2085	2258	235	290	G6"	237

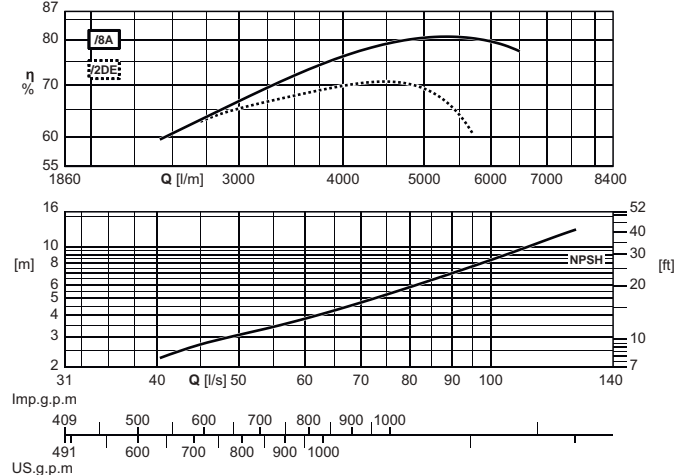
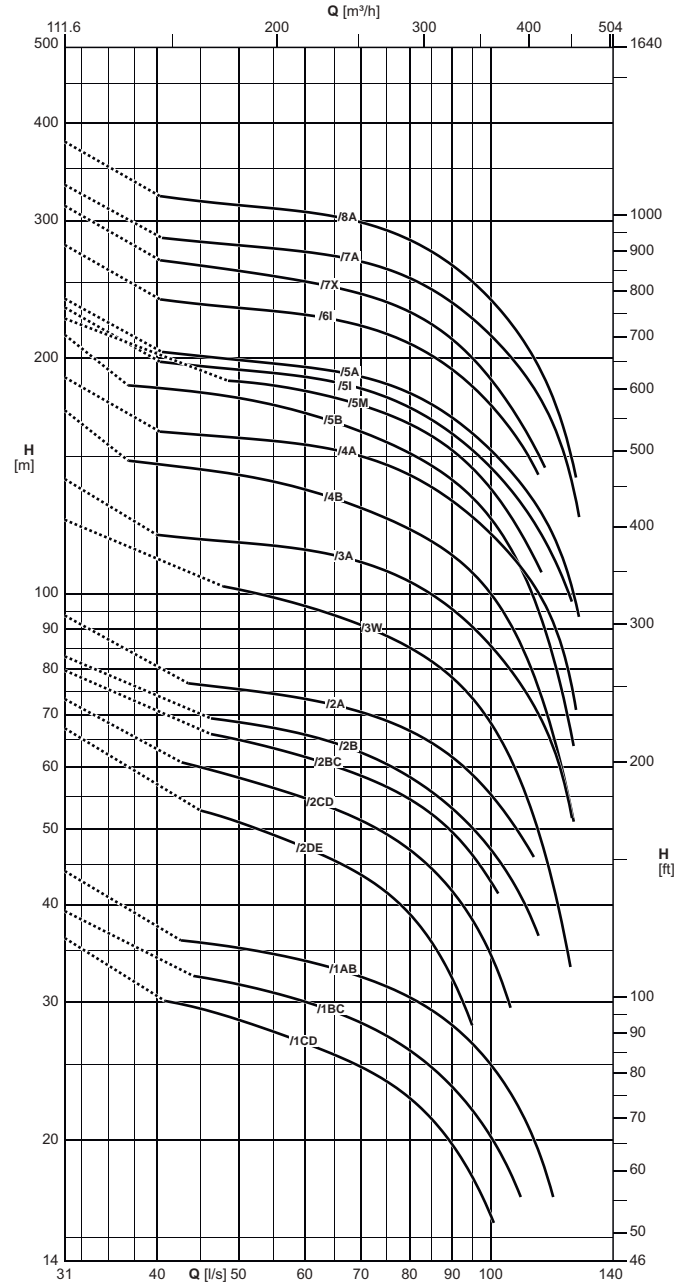

The hydraulic performance characteristics are guaranteed as conforming to standard UNI/ISO 9906 Grade 3B.
 Available with NPT thread.

Les caractéristiques hydrauliques de fonctionnement sont garanties conformes à la norme UNI/ISO 9906 Niveau 3B.
 Disponible avec filetage NPT.

Le caratteristiche di funzionamento vengono garantite secondo la norma: UNI/ISO 9906 Grado 3B.
 Disponibile con filettatura NPT.

Operating data
Caracteristiques de fonctionnement
Caratteristiche di funzionamento

Electric pump type Electropompe type Elettropompa tipo	Motor power Puis. moteur Potenza motore		Horizontal installation Installation horizontale Installazione orizzontale	Check valve \varnothing Clapet de retenue \varnothing Valvola di ritegno \varnothing	Capacity Debit Portata																	
					[l/s]	0	35	40	45	50	55	60	65	70	75	80	85	90	95	100	110	120
	[l/min]	0			2100	2400	2700	3000	3300	3600	3900	4200	4500	4800	5100	5400	5700	6000	6600	7200		
	[m ³ /h]	0			126	144	162	180	198	216	234	252	270	288	306	324	342	360	396	432		
[kW]	[HP]	Head Hauteur Prevalenza																				
E10PX315/1CD+MACW635A	26	35	<input type="checkbox"/>	6" Gas	[m]	36,5	-	-	29,5	28,5	27,5	26,5	25,5	25	24	22,5	21,5	19,5	18	16	-	-
E10PX315/1BC+MACW640A	30	40	<input type="radio"/>	6" Gas	[m]	39,5	-	-	32,5	31,5	31	30	29	28	27	26	25	23,5	22	20	-	-
E10PX315/1BC+MACW840	30	40	<input type="checkbox"/>	6" Gas	[m]	39,5	-	-	33	32	31,5	30,5	29,5	29	28	26,5	25,5	24	22,5	21	-	-
E10PX315/1AB+MACW650B	37	50	<input type="radio"/>	6" Gas	[m]	44	-	-	36	35	34,5	34	33	32,5	31,5	30,5	29,5	28	26,5	25	21	-
E10PX315/1AB+MACW850	37	50	<input type="checkbox"/>	6" Gas	[m]	44,5	-	-	36,5	35,5	35	34,5	33,5	33	32	31	30	29	27,5	26	22	-
E10PX315/2A+MACW8100	75	100	<input type="radio"/>	6" Gas	[m]	94	-	-	76	75	74	73	72	70	69	67	64	62	59	55	48	-
E10PX315/2A+MACW10100A	75	100	<input type="checkbox"/>	6" Gas	[m]	94	-	-	77	76	75	74	73	71	70	68	66	63	60	57	49,5	-
E10PX315/2DE+MACW660B	45	60	<input type="radio"/>	6" Gas	[m]	67	-	-	53	51	49	47,5	45,5	43,5	41,5	39	36	32	28	-	-	-
E10PX315/2DE+MACW860	45	60	<input type="checkbox"/>	6" Gas	[m]	68	-	-	54	53	51	49,5	47,5	45,5	43	40,5	37	33	-	-	-	-
E10PX315/2CD+MACW870	51	70	<input type="checkbox"/>	6" Gas	[m]	73	-	-	60	58	56	55	53	51	49,5	47	44,5	41,5	38,5	34,5	-	-
E10PX315/2BC+MACW880	59	80	<input type="checkbox"/>	6" Gas	[m]	80	-	-	65	63	62	60	58	57	55	52	49,5	46,5	43	-	-	-
E10PX315/2B+MACW890	66	90	<input type="checkbox"/>	6" Gas	[m]	83	-	-	68	67	66	64	63	61	58	56	53	50	47	40	-	-
E10PX315/3W+MACW8125	92	125	<input type="radio"/>	6" Gas	[m]	124	-	-	101	99	96	94	91	88	85	82	78	73	68	55	40,5	-
E10PX315/3W+MACW10125A	92	125	<input type="checkbox"/>	6" Gas	[m]	125	-	-	102	101	98	96	93	90	87	83	80	75	70	57	-	-
E10PX315/3A+MACW8150	110	150	<input type="radio"/>	6" Gas	[m]	140	-	119	117	116	115	114	112	110	107	103	100	95	91	86	75	62
E10PX315/3A+MACW10150A	110	150	<input type="checkbox"/>	6" Gas	[m]	141	121	120	119	118	117	116	114	112	109	106	102	98	94	89	78	65
E10PX315/4B+MACW10180A	132	180	<input type="checkbox"/>	6" Gas	[m]	171	-	146	144	142	139	136	132	129	125	121	116	112	106	100	83	63
E10PX315/4A+MACW10200A	150	200	<input type="radio"/>	6" Gas	[m]	189	-	-	160	158	157	155	153	150	146	142	137	131	125	119	106	89
E10PX315/5B+MACW10220A	160	220	<input type="radio"/>	6" Gas	[m]	214	-	183	181	178	174	170	166	161	156	151	146	140	133	125	105	79
E10PX315/5M+MACW12230A	170	230	<input type="checkbox"/>	6" Gas	[m]	225	-	-	187	185	182	178	174	170	165	159	152	145	136	117	-	-
E10PX315/5I+MACW10250A	185	250	<input type="radio"/>	6" Gas	[m]	232	-	-	195	193	191	189	186	183	178	173	167	160	153	145	128	109
E10PX315/5A+MACW12260A	190	260	<input type="checkbox"/>	6" Gas	[m]	238	-	-	201	199	197	195	192	189	185	180	175	168	160	153	136	115
E10PX315/6I+MACW12300C	220	300	<input type="checkbox"/>	6" Gas	[m]	279	-	-	235	232	230	227	224	220	215	209	202	193	184	174	152	-
E10PX315/6I+MW14300	220	300	<input type="radio"/>	6" Gas	[m]	281	-	-	237	234	231	228	225	221	216	210	203	196	187	178	156	130
E10PX315/7X+MW14330	240	330	<input type="radio"/>	6" Gas	[m]	315	-	-	265	261	257	253	249	245	239	233	224	214	203	191	164	-
E10PX315/7X+MACW12340C	250	340	<input type="radio"/>	6" Gas	[m]	313	-	-	263	259	255	251	246	242	236	229	221	211	200	188	162	-
E10PX315/7A+MW14380	280	380	<input type="radio"/>	6" Gas	[m]	333	-	-	282	279	276	274	270	266	260	253	245	235	225	214	190	160
E10PX315/8A+MACW12400C	295	400	<input type="radio"/>	6" Gas	[m]	379	-	-	318	314	311	308	304	298	292	284	274	263	251	238	208	172
NPSH					[m]	-	2,2	2,5	2,6	3	3,4	3,8	4,2	4,7	5,2	5,7	6,3	7	7,7	8,4	10	11,5

■ Without conical valve

On request

Please contact our sales organisation

For motor performances specification see page "motor features"

■ Sans soupape du clapet.

Sur demande

Contacter notre service commercial.

Pour caractéristiques techniques moteurs voir page "Caractéristiques des moteurs"

■ Senza clapet valvola di ritegno

Su richiesta

Interpellare la sede o la rete di vendita

Per caratteristiche motori vedere pagina "caratteristiche motori"

Temperature monitoring device for submersed electric motors 6" ÷ 14": see page "Accessories"

Appareillage de contrôle de la température des moteurs électriques immergés 6" ÷ 14": voir page "Accessories"

Apparecchiatura di controllo temperatura motori elettrici sommersi 6" ÷ 14": vedere pagina accessori

Operating data
Caractéristiques de fonctionnement
Caratteristiche di funzionamento

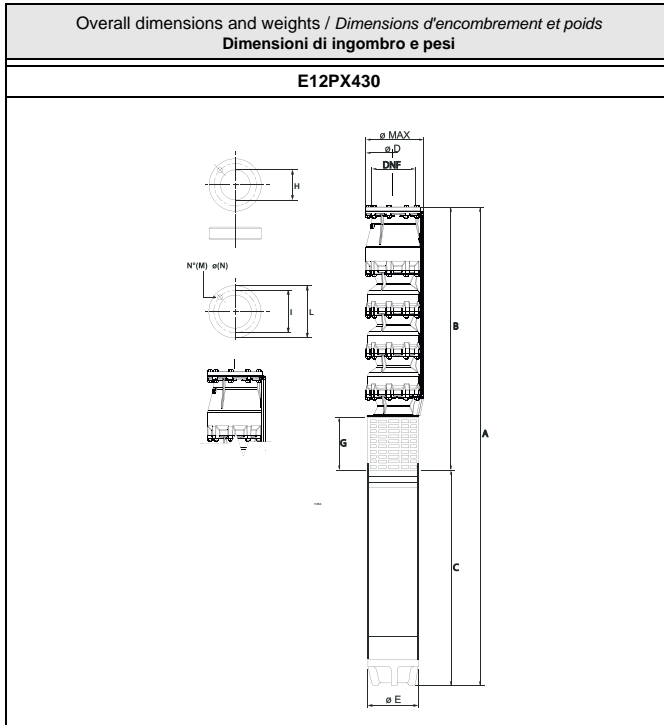

Type Type Tipo	Ø max [mm]	Weight Poids Peso [kg]	A	B	C	D	E	F	G
			[mm]						
E12PX430/1B+MACW8100	303	351,4	2474,5	974,5	1500	290	191	221	282
E12PX430/1B+MACW10100A	303	416,4	2380,5	974,5	1406	290	242	221	282
E12PX430/1A+MACW8125	303	381,4	2659,5	974,5	1685	290	191	221	282
E12PX430/1A+MACW10125A	303	454,4	2510,5	974,5	1536	290	242	221	282
E12PX430/1D+MACW850	303	271,4	2089,5	974,5	1115	290	191	221	282
E12PX430/1CJ+MACW860	303	288,4	2169,5	974,5	1195	290	191	221	282
E12PX430/1CD+MACW870	303	308,4	2264,5	974,5	1290	290	191	221	282
E12PX430/1C+MACW880	303	326,4	2369,5	974,5	1395	290	191	221	282
E12PX430/1BC+MACW890	303	335,4	2404,5	974,5	1430	290	191	221	282
E12PX430/2D+MACW8100	303	388,4	2689,5	1189,5	1500	290	191	221	282
E12PX430/2D+MACW10100A	303	453,4	2595,5	1189,5	1406	290	242	221	282
E12PX430/2CD+MACW8125	303	418,4	2874,5	1189,5	1685	290	191	221	282
E12PX430/2CD+MACW10125A	303	491,4	2725,5	1189,5	1536	290	242	221	282
E12PX430/2C+MACW8150	303	436,4	2949,5	1189,5	1760	290	191	221	282
E12PX430/2C+MACW10150A	303	526,4	2830,5	1189,5	1641	290	242	221	282
E12PX430/2B+MACW10180A	303	561,4	2955,5	1189,5	1766	290	242	221	282
E12PX430/2AB+MACW10200A	303	589,4	3055,5	1189,5	1866	290	242	221	282
E12PX430/2A+MACW12230A	320,5	849,9	3128	1170	1958	290	290	221	263
E12PX430/2E+MACW880	303	363,4	2584,5	1189,5	1395	290	191	221	282
E12PX430/2DE+MACW890	303	372,4	2619,5	1189,5	1430	290	191	221	282
E12PX430/3CJ+MACW10180A	303	598,3	3170,5	1404,5	1766	290	242	221	282
E12PX430/3JD+MACW10200A	303	626,3	3270,5	1404,5	1866	290	242	221	282
E12PX430/3C+MACW12230A	320,5	886,8	3343	1385	1958	290	290	221	263
E12PX430/3Q+MACW10250A	303	689,3	3530,5	1404,5	2126	290	242	221	282
E12PX430/3W+MACW12260A	320,5	954,8	3493	1385	2108	290	290	221	263
E12PX430/3AB+MACW12300C	320,5	886,8	3343	1385	1958	290	290	221	263
E12PX430/3AB+MW14300	320,5	1007,8	3312	1385	1927	290	337	221	263
E12PX430/3A+MW14330	320,5	1037,8	3367	1385	1982	290	337	221	263
E12PX430/3A+MACW12340C	320,5	954,8	3493	1385	2108	290	290	221	263

Holes Trous Fori		I	L	Counterflange Contrebride Controflangia
M	N			H
N°		Ø [mm]		
9	15	264	290	221

Pumps is equipped with gasket, counterflange and bolts.
The hydraulic performance characteristics are guaranteed as conforming to standard UNI/ISO 9906 Grade 3B.
Available with NPT thread.

La pompe est équipée avec garniture, contrebride et boulons.
Les caractéristiques hydrauliques de fonctionnement sont garanties conformes à la norme UNI/ISO 9906 Niveau 3B.
Disponible avec filetage NPT.

La pompa è corredata di guarnizione, controflangia e bulloni
Le caratteristiche di funzionamento vengono garantite secondo la norma: UNI/ISO 9906 Grado 3B.
Disponibile con filettatura NPT.

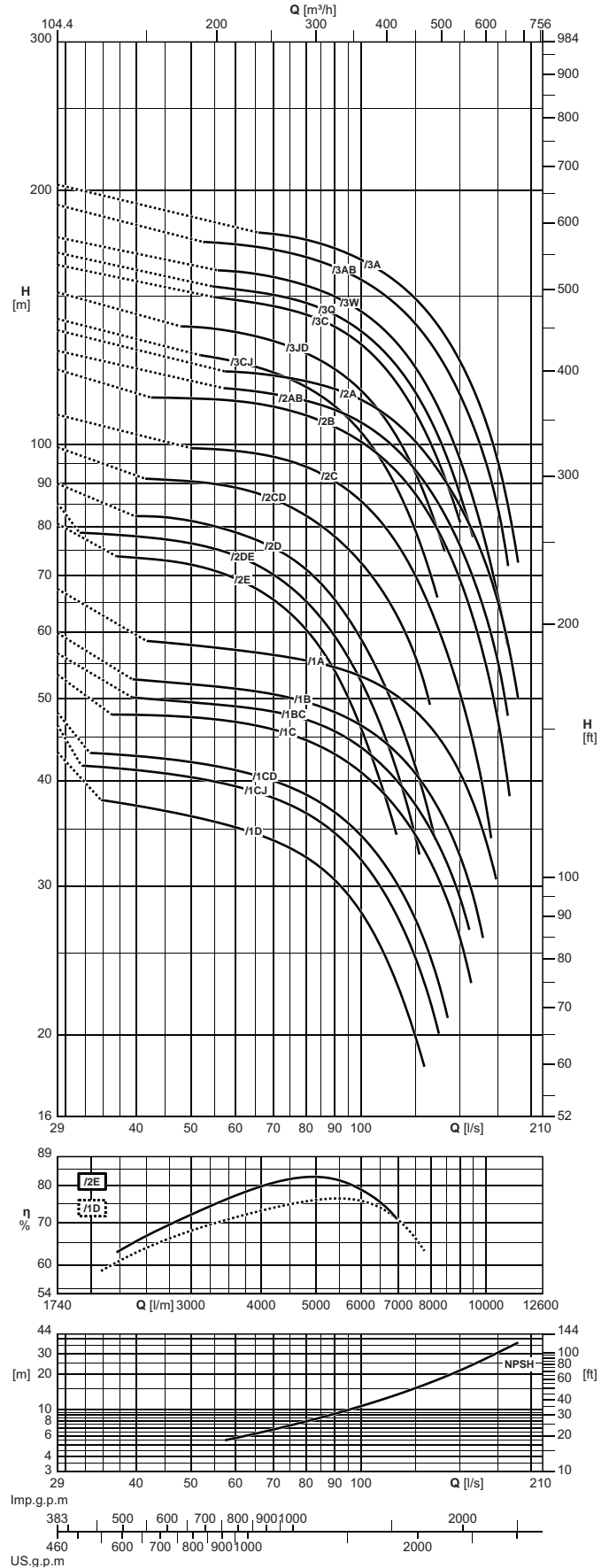

Operating data
Caracteristiques de fonctionnement
Caratteristiche di funzionamento

Electric pump type Electropompe type Elettropompa tipo	Motor power Puiss. moteur Potenza motore		Horizontal installation Installation horizontale Installazione orizzontale	Check valve Ø/Clapet de retenue Ø Valvola di ritegno Ø	Capacity Debit Portata																			
	[kW]	[HP]			[l/s]	0	35	40	45	50	60	70	80	90	100	110	120	130	140	150	160	170	180	190
					[l/min]	0	2100	2400	2700	3000	3600	4200	4800	5400	6000	6600	7200	7800	8400	9000	9600	10200	10800	11400
					[m³/h]	0	126	144	162	180	216	252	288	324	360	396	432	468	504	540	576	612	648	684
		Head Hauteur Prevalenza																						
E12PX430/1B+MACW8100	75	100	○	Ø 221	[m]	60	-	53	52	52	51	51	49,5	48	46,5	44,5	42	39,5	36	32,5	28,5	-	-	-
E12PX430/1B+MACW10100A	75	100	□	Ø 221	[m]	60	-	53	53	52	52	51	50	49	47	45	42,5	40	36,5	33	29	-	-	-
E12PX430/1A+MACW8125	92	125	○	Ø 221	[m]	67	-	-	58	58	57	56	55	54	53	51	49,5	47	44	41	37	32,5	-	-
E12PX430/1A+MACW10125A	92	125	□	Ø 221	[m]	68	-	-	59	58	58	57	56	55	54	52	50	48	45	42	37,5	33	-	-
E12PX430/1D+MACW850	37	50	□	Ø 221	[m]	43	38	37,5	37	36,5	35	34	32,5	30,5	28	25	21,5	-	-	-	-	-	-	-
E12PX430/1CJ+MACW860	45	60	□	Ø 221	[m]	46,5	41,5	41	41	40,5	39,5	38	36,5	34,5	32	29,5	26,5	23	-	-	-	-	-	-
E12PX430/1CD+MACW870	51	70	□	Ø 221	[m]	48	43	43	42,5	42	41	40	38,5	36,5	34,5	32	29	25,5	22	-	-	-	-	-
E12PX430/1C+MACW880	59	80	□	Ø 221	[m]	53	-	48	47,5	47,5	47	46	44,5	43	41	38,5	36	33	29,5	26	-	-	-	-
E12PX430/1BC+MACW890	66	90	□	Ø 221	[m]	57	-	50	50	49,5	49	48,5	47	45,5	44	41,5	39	36	32,5	29	-	-	-	-
E12PX430/2D+MACW8100	75	100	○	Ø 221	[m]	90	-	82	82	81	79	75	71	65	59	52	45	38	-	-	-	-	-	-
E12PX430/2D+MACW10100A	75	100	□	Ø 221	[m]	90	-	83	83	82	80	76	72	67	61	54	47	39,5	-	-	-	-	-	-
E12PX430/2CD+MACW8125	92	125	○	Ø 221	[m]	99	-	-	91	90	89	86	82	78	72	66	60	52	-	-	-	-	-	-
E12PX430/2CD+MACW10125A	92	125	□	Ø 221	[m]	100	-	-	92	91	90	87	84	80	74	68	61	54	-	-	-	-	-	-
E12PX430/2C+MACW8150	110	150	○	Ø 221	[m]	108	-	-	-	-	98	97	94	90	86	80	73	66	58	51	43	34,5	-	-
E12PX430/2C+MACW10150A	110	150	□	Ø 221	[m]	109	-	-	-	-	100	98	95	92	88	82	76	68	60	53	45	36,5	-	-
E12PX430/2B+MACW10180A	132	180	□	Ø 221	[m]	123	-	-	114	113	112	111	108	105	101	96	90	84	77	69	61	52	42	-
E12PX430/2AB+MACW10200A	150	200	○	Ø 221	[m]	129	-	-	-	-	116	115	113	110	106	102	96	90	83	76	68	60	50	-
E12PX430/2A+MACW12230A	170	230	□	Ø 221	[m]	137	-	-	-	-	122	121	119	116	113	109	104	98	91	84	77	69	60	50
E12PX430/2E+MACW880	59	80	□	Ø 221	[m]	80	-	73	73	72	69	65	60	54	46	38,5	-	-	-	-	-	-	-	-
E12PX430/2DE+MACW890	66	90	□	Ø 221	[m]	85	78	78	77	76	74	70	65	59	52	45,5	38	-	-	-	-	-	-	-
E12PX430/3CJ+MACW10180A	132	180	□	Ø 221	[m]	141	-	-	-	-	125	122	117	111	103	95	84	73	-	-	-	-	-	-
E12PX430/3JD+MACW10200A	150	200	○	Ø 221	[m]	151	-	-	-	138	136	133	128	123	116	108	98	87	76	-	-	-	-	-
E12PX430/3C+MACW12230A	170	230	□	Ø 221	[m]	163	-	-	-	-	148	146	142	138	131	123	114	104	92	81	-	-	-	-
E12PX430/3Q+MACW10250A	185	250	○	Ø 221	[m]	169	-	-	-	-	153	150	147	142	136	129	120	110	99	87	-	-	-	-
E12PX430/3W+MACW12260A	190	260	□	Ø 221	[m]	176	-	-	-	-	160	158	154	150	144	137	128	118	107	96	84	72	60	-
E12PX430/3AB+MACW12300C	220	300	□	Ø 221	[m]	192	-	-	-	-	173	170	167	162	157	150	143	134	125	114	103	91	76	-
E12PX430/3AB+MW14300	220	300	○	Ø 221	[m]	193	-	-	-	-	173	171	168	164	159	153	146	137	127	116	105	92	78	-
E12PX430/3A+MW14330	240	330	○	Ø 221	[m]	204	-	-	-	-	-	179	176	172	168	162	155	147	138	128	117	105	90	74
E12PX430/3A+MACW12340C	250	340	□	Ø 221	[m]	203	-	-	-	-	-	177	175	171	166	160	153	145	135	125	114	102	88	72
NPSH					[m]	-	4,2	4,2	4,5	4,9	5,6	6,8	7,8	9,1	11	12	14	16,5	18,5	21,5	25	29	32,5	37

■ Without conical valve

□ On request

○ Please contact our sales organisation

For motor performances specification see page "motor features"

Temperature monitoring device for submersed electric motors 6" ± 14": see page "Accessories"

■ Sans soupape du clapet.

□ Sur demande

○ Contacter notre service commercial.

Pour caractéristiques techniques moteurs voir page "Caractéristiques des moteurs"

Appareillage de contrôle de la température des moteurs électriques immergés 6" ± 14": voir page "Accessories"

■ Senza clapet valvola di ritegno

□ Su richiesta

○ Interpellare la sede o la rete di vendita

Per caratteristiche motori vedere pagina "caratteristiche motori"

Apparecchiatura di controllo temperatura motori elettrici sommersi 6" ± 14": vedere pagina accessori

Operating data
Caracteristiques de fonctionnement
Caratteristiche di funzionamento

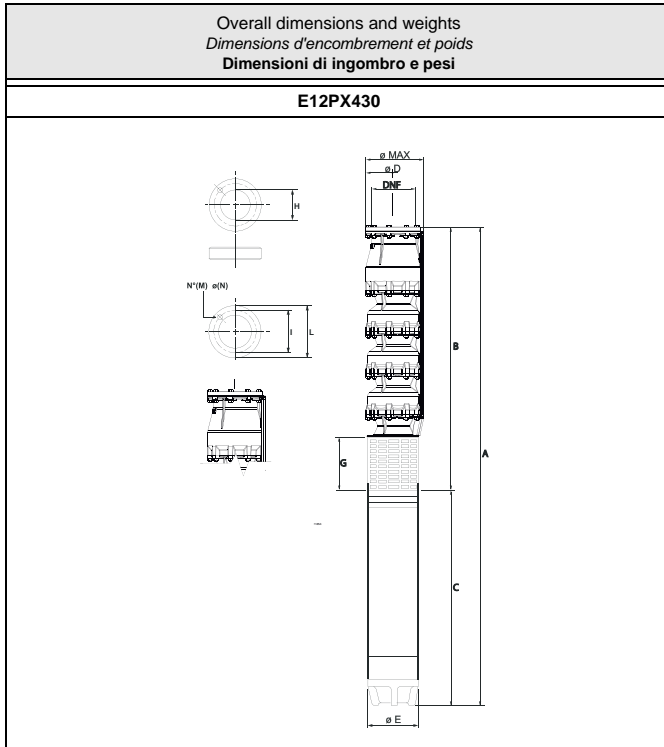

Type Type Tipo	Ø max [mm]	Weight Poids Peso [kg]	A	B	C	D	E	F	G
			[mm]						
E12PXE430/4D+MACW12230A	320.5	923.8	3558	1600	1958	290	290	221	263
E12PXE430/4CD+MACW10250A	303	726.3	3745.5	1619.5	2126	290	242	221	282
E12PXE430/4CD+MACW12260A	320.5	991.8	3708	1600	2108	290	290	221	263
E12PXE430/4C+MACW12300C	320.5	923.8	3558	1600	1958	290	290	221	263
E12PXE430/4C+MW14300	320.5	1044.8	3527	1600	1927	290	337	221	263
E12PXE430/4M+MW14380	320.5	1113.8	3642	1600	2042	290	337	221	263
E12PXE430/4I+MACW12400C	320.5	1044.8	3858	1600	2258	290	290	221	263
E12PXE430/4I+MW14430	320.5	1207.8	3792	1600	2192	290	337	221	263
E12PXE430/4A+MW14460	320.5	1268.8	3892	1600	2292	290	337	221	263
E12PXE430/5JD+MACW12340C	320.5	1028.8	3923	1815	2108	290	290	221	263
E12PXE430/5C+MW14380	320.5	1150.8	3857	1815	2042	290	337	221	263
E12PXE430/5BC+MACW12400C	320.5	1081.8	4073	1815	2258	290	290	221	263
E12PXE430/5BC+MW14430	320.5	1244.8	4007	1815	2192	290	337	221	263
E12PXE430/5B+MW14460	320.5	1305.8	4107	1815	2292	290	337	221	263
E12PXE430/5MN+MACW12475C	320.5	1106.8	4123	1815	2308	290	290	221	263
E12PXE430/5K+MW14500	320.5	1387.8	4227	1815	2412	290	337	221	263
E12PXE430/5A+MACW12540C	320.5	1127.8	4173	1815	2358	290	290	221	263

Holes Trous Fori		I	L	Counterflange Contrebride Controflangia
M	N			
N°		Ø [mm]		
9	15	264	290	221

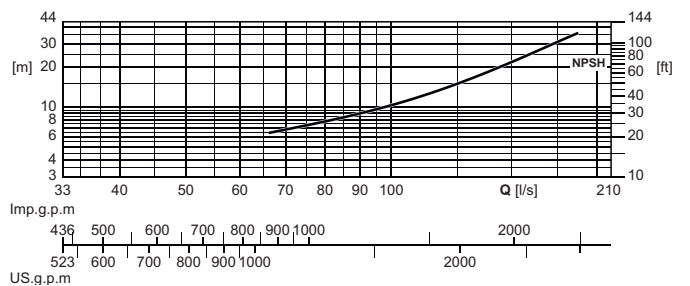
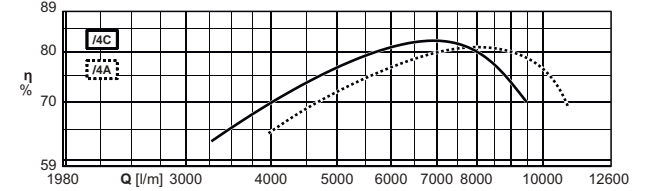
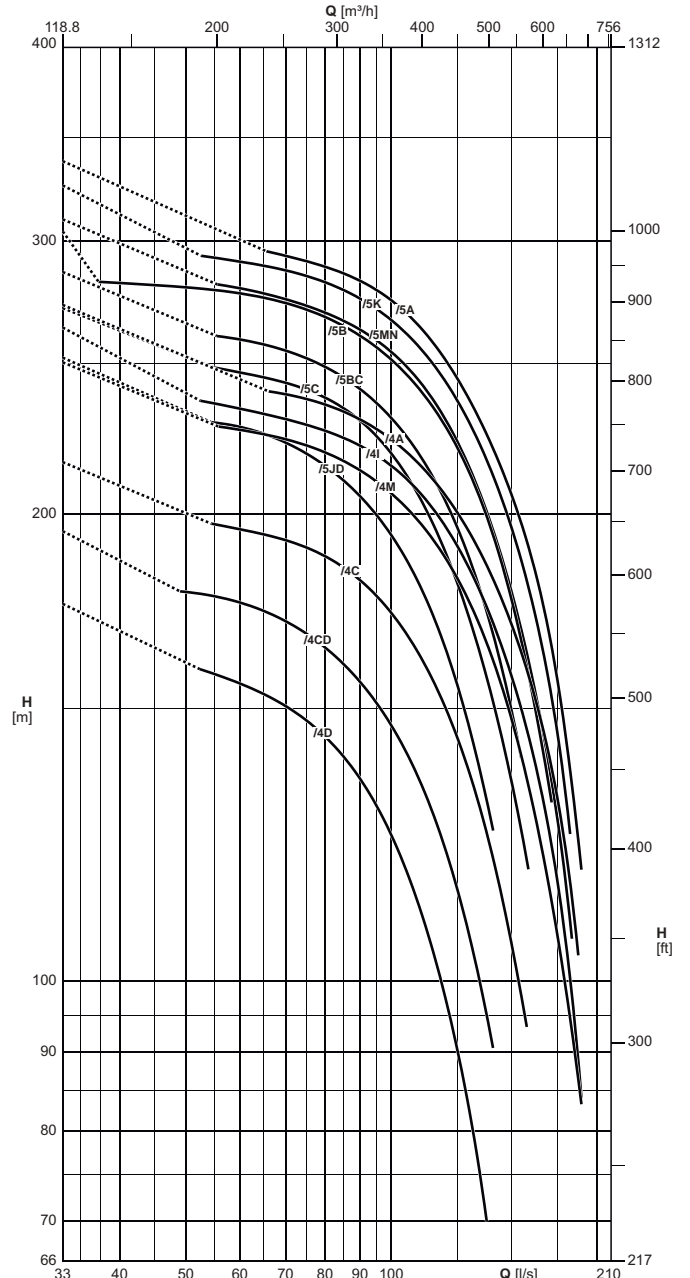

The hydraulic performance characteristics are guaranteed as conforming to standard UNI/ISO 9906 Grade 3B. Available with NPT thread.

Les caractéristiques hydrauliques de fonctionnement sont garanties conformes à la norme UNI/ISO 9906 Niveau 3B. Disponible avec filetage NPT.

Le caratteristiche di funzionamento vengono garantite secondo la norma: UNI/ISO 9906 Grado 3B. Disponibile con filettatura NPT.

Operating data
Caracteristiques de fonctionnement
Caratteristiche di funzionamento

Electric pump type Electropompe type Elettropompa tipo	Motor power Puiss. moteur Potenza motore		Horizontal installation Installation horizontale Installazione orizzontale	Check valve Ø Clapet de retenue Ø Valvola di ritegno Ø	Capacity Debit Portata																		
	[kW]	[HP]			[l/s]	0	40	45	50	60	70	80	90	100	110	120	130	140	150	160	170	180	190
					[l/min]	0	2400	2700	3000	3600	4200	4800	5400	6000	6600	7200	7800	8400	9000	9600	10200	10800	11400
					[m³/h]	0	144	162	180	216	252	288	324	360	396	432	468	504	540	576	612	648	684
		Head Hauteur Prevalenza																					
		[m]	175	-	-	-	155	150	144	135	124	111	97	83	-	-	-	-	-	-	-		
E12PXE430/4D+MACW12230A	170	230	□	Ø 221	[m]	175	-	-	-	155	150	144	135	124	111	97	83	-	-	-	-	-	
E12PXE430/4CD+MACW10250A	185	250	○	Ø 221	[m]	195	-	-	178	175	170	164	156	146	135	121	107	92	-	-	-	-	-
E12PXE430/4CD+MACW12260A	190	260	□	Ø 221	[m]	196	181	181	180	176	172	166	158	149	138	125	110	95	-	-	-	-	-
E12PXE430/4C+MACW12300C	220	300	□	Ø 221	[m]	216	-	-	-	195	192	188	181	173	162	150	136	121	106	-	-	-	-
E12PXE430/4C+MW14300	220	300	○	Ø 221	[m]	217	-	-	-	197	194	190	184	175	165	152	138	123	108	-	-	-	-
E12PXE430/4M+MW14380	280	380	○	Ø 221	[m]	250	-	-	-	227	223	219	213	206	197	187	176	162	147	132	115	99	83
E12PXE430/4I+MACW12400C	295	400	○	Ø 221	[m]	264	-	-	-	234	230	226	221	215	206	196	184	171	157	142	125	106	84
E12PXE430/4I+MW14430	315	430	○	Ø 221	[m]	265	-	-	-	237	234	230	225	218	210	200	188	176	162	148	132	113	-
E12PXE430/4A+MW14460	340	460	○	Ø 221	[m]	273	-	-	-	-	239	235	230	223	215	206	195	183	170	156	140	122	-
E12PXE430/5JD+MACW12340C	250	340	○	Ø 221	[m]	252	-	-	-	228	222	215	205	194	180	164	146	127	-	-	-	-	-
E12PXE430/5C+MW14380	280	380	○	Ø 221	[m]	272	-	-	-	247	243	238	230	219	205	189	172	153	134	-	-	-	-
E12PXE430/5BC+MACW12400C	295	400	○	Ø 221	[m]	287	-	-	-	259	255	249	241	231	218	204	187	169	150	-	-	-	-
E12PXE430/5BC+MW14430	315	430	○	Ø 221	[m]	288	-	-	-	262	258	253	245	235	223	209	193	175	155	-	-	-	-
E12PXE430/5B+MW14460	340	460	○	Ø 221	[m]	304	282	281	280	278	274	268	261	251	241	228	213	195	176	155	134	-	-
E12PXE430/5MN+MACW12475C	350	475	○	Ø 221	[m]	310	-	-	-	280	275	270	263	254	244	230	214	197	178	159	138	116	-
E12PXE430/5K+MW14500	370	500	○	Ø 221	[m]	326	-	-	-	291	287	282	275	267	256	243	229	213	196	177	156	132	-
E12PXE430/5A+MACW12540C	400	540	○	Ø 221	[m]	338	-	-	-	-	293	289	283	275	264	251	237	222	206	188	168	144	118
NPSH					[m]	-	4,2	4,5	4,9	5,6	6,8	7,8	9,1	11	12	14	16,5	18,5	21,5	25	29	32,5	37

■ Without conical valve

□ On request

○ Please contact our sales organisation

For motor performances specification see page "motor features"

Temperature monitoring device for submersed electric motors 6" ÷ 14": see page "Accessories"

■ Sans soupape du clapet.

□ Sur demande

○ Contacter notre service commercial.

Pour caractéristiques techniques moteurs voir page "Caractéristiques des moteurs"

Appareillage de contrôle de la température des moteurs électriques immergés 6" ÷ 14": voir page "Accessories"

■ Senza clapet valvola di ritegno

□ Su richiesta

○ Interpellare la sede o la rete di vendita

Per caratteristiche motori vedere pagina "caratteristiche motori"

Apparecchiatura di controllo temperatura motori elettrici sommersi 6" ÷ 14": vedere pagina accessori

Operating data
 Caracteristiques de fonctionnement
 Caratteristiche di funzionamento

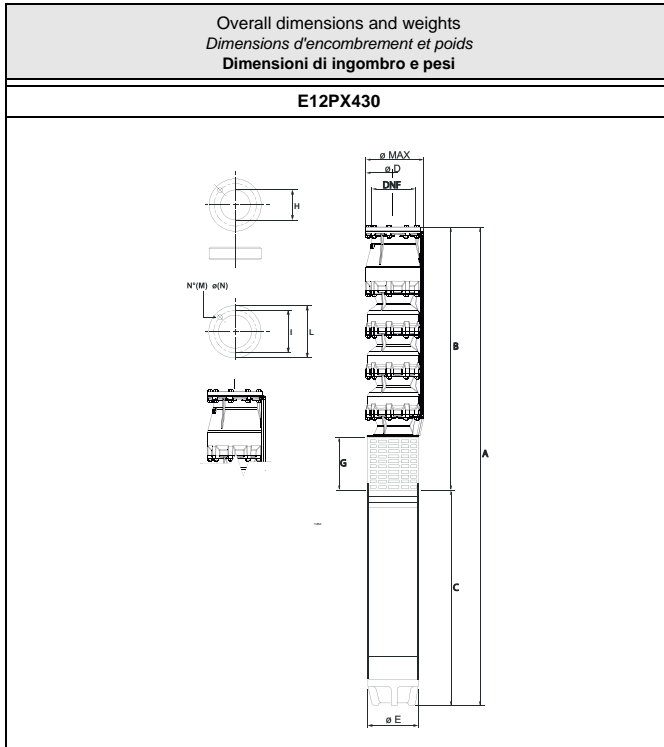

Type Type Tipo	Ø max	Weight Poids Peso	A	B	C	D	E	F	G
	[mm]								
E12PXE430/6BJ+MACW12475C	320.5	1143,7	4338	2030	2308	290	290	221	263
E12PXE430/7QC+MW14500	320.5	1461,7	4657	2245	2412	290	337	221	263
E12PXE430/7C+MACW12540C	320.5	1201,7	4603	2245	2358	290	290	221	263
E12PXE430/8D+MW14430	320.5	1355,7	4652	2460	2192	290	337	221	263
E12PXE430/9D+MW14460	320.5	1453,7	4967	2675	2292	290	337	221	263
E12PXE430/9D+MACW12475C	320.5	1254,7	4983	2675	2308	290	290	221	263
E12PXE430/11D+MACW12540C	320.5	1349,6	5463	3105	2358	290	290	221	263

Holes Trous Fori		I	L	Counterflange Contrebride Controflangia
M	N			
N°		Ø [mm]		
9	15	264	290	221

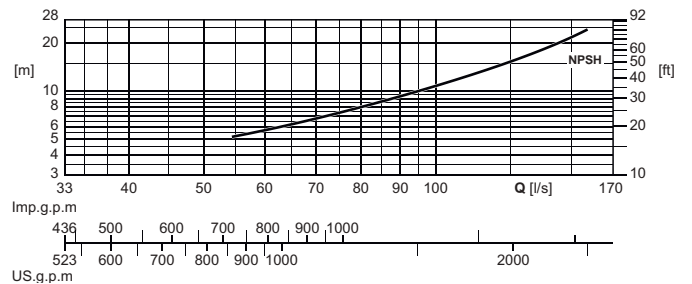
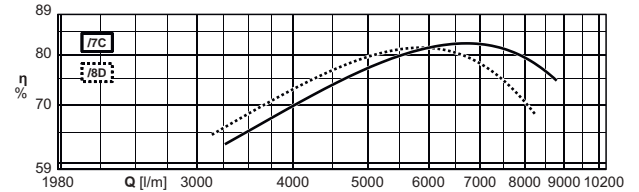
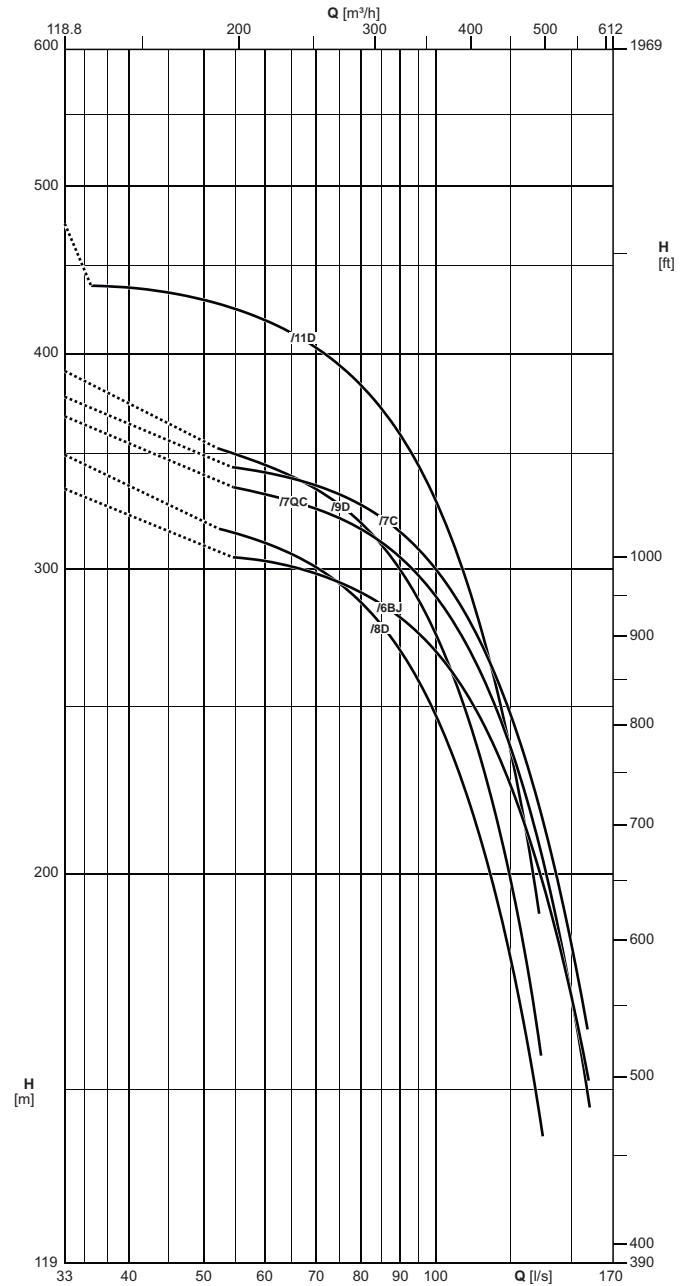

The hydraulic performance characteristics are guaranteed as conforming to standard UNI/ISO 9906 Grade 3B. Available with NPT thread.

Les caractéristiques hydrauliques de fonctionnement sont garanties conformes à la norme UNI/ISO 9906 Niveau 3B. Disponible avec filetage NPT.

Le caratteristiche di funzionamento vengono garantite secondo la norma: UNI/ISO 9906 Grado 3B. Disponibile con filettatura NPT.

Operating data
Caracteristiques de fonctionnement
Caratteristiche di funzionamento

Electric pump type Electropompe type Elettropompa tipo	Motor power Puiss. moteur Potenza motore		Horizontal installation Installation horizontale Installazione orizzontale	Check valve Ø Clapet de retenue Ø Valvola di ritegno Ø	Capacity Debit Portata														
					[l/s]	0	40	45	50	60	70	80	90	100	110	120	130	140	150
	[l/min]	0			2400	2700	3000	3600	4200	4800	5400	6000	6600	7200	7800	8400	9000		
	[m³/h]	0			144	162	180	216	252	288	324	360	396	432	468	504	540		
[kW]	[HP]	Head Hauteur Prevalenza																	
E12PXE430/6BJ+MACW12475C	350	475	○	Ø 221	[m]	334	-	-	-	303	298	291	281	269	253	235	214	192	170
E12PXE430/7QC+MW14500	370	500	○	Ø 221	[m]	368	-	-	-	332	325	316	305	289	271	249	224	198	170
E12PXE430/7C+MACW12540C	400	540	○	Ø 221	[m]	378	-	-	-	341	335	327	315	300	281	259	235	209	182
E12PXE430/8D+MW14430	315	430	○	Ø 221	[m]	349	-	-	-	311	301	287	269	247	221	193	164	-	-
E12PXE430/9D+MW14460	340	460	○	Ø 221	[m]	393	363	361	358	349	338	323	304	280	251	220	186	-	-
E12PXE430/9D+MACW12475C	350	475	○	Ø 221	[m]	391	-	-	-	345	334	319	300	275	246	215	182	-	-
E12PXE430/11D+MACW12540C	400	540	○	Ø 221	[m]	476	437	434	430	418	403	383	359	329	294	256	216	-	-
NPSH					[m]	-	4,2	4,5	4,9	5,6	6,8	7,8	9,1	11	12	14	16,5	18,5	21,5

■ Without conical valve

□ On request

○ Please contact our sales organisation

For motor performances specification see page "motor features"

Temperature monitoring device for submersed electric motors 6" ÷ 14": see page "Accessories"

■ Sans soupape du clapet.

□ Sur demande

○ Contacter notre service commercial.

Pour caracteristiques techniques moteurs voir page "Caracteristiques des moteurs"

Appareillage de contrôle de la température des moteurs électriques immergés 6" ÷ 14": voir page "Accessories"

■ Senza clapet valvola di ritegno

□ Su richiesta

○ Interpellare la sede o la rete di vendita

Per caratteristiche motori vedere pagina "caratteristiche motori"

Apparecchiatura di controllo temperatura motori elettrici sommersi 6" ÷ 14": vedere pagina accessori

Friction losses
Pertes de charge
Perdite di carico

In the check valves of MIXED-FLOW pumps
Dans les clapets de retenue des électropompes SEMI-AXIALES
Nelle valvole di ritegno delle elettropompe SEMIASSIALI

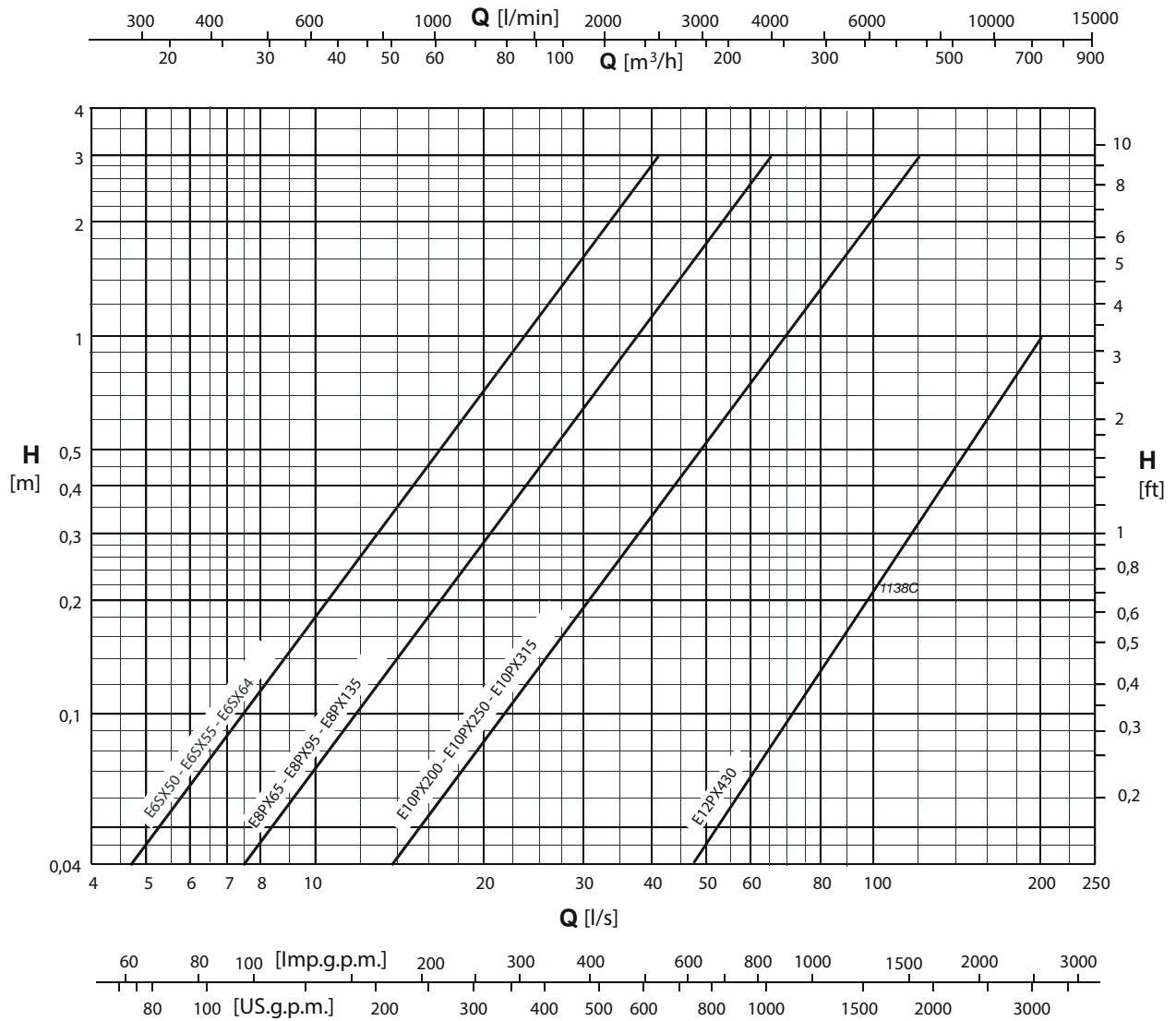

N.B. Friction losses in the check valves of radial pumps are included in the total head.
Les pertes de charge dans les clapets de retenue des électropompes radiales sont comprises dans la HMT.
Le perdite di carico nelle valvole di ritegno delle elettropompe radiali sono già conteggiate nella prevalenza totale.

Friction losses
Pertes de charge
Perdite di carico

In feet every 100 feet of straight pipeline
En mètres pour 100 mètres de tuyauterie droite
In metri ogni 100 metri di tubazione dritta

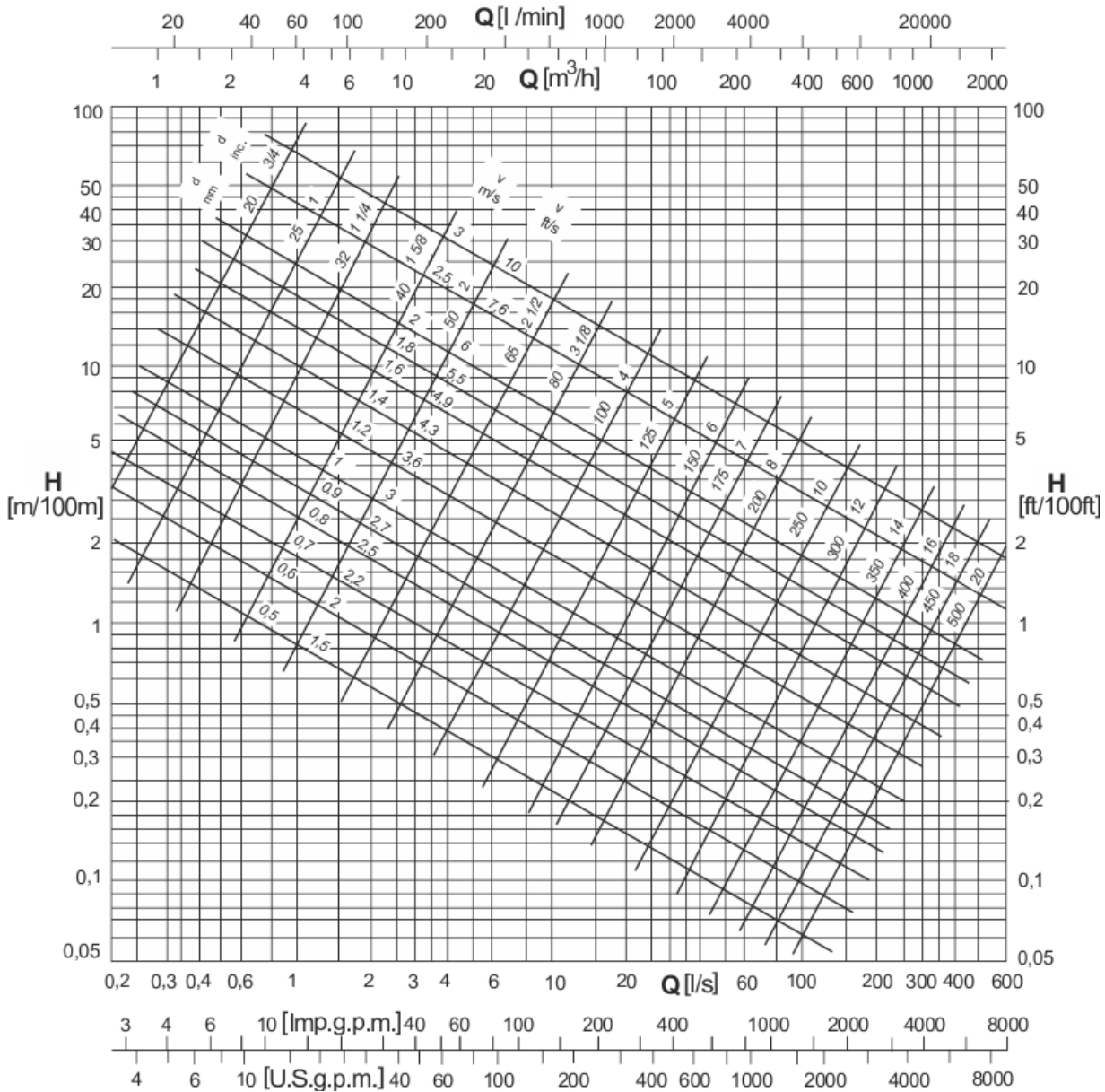

Notes: Above mentioned values are to be intended for internally smooth cast iron pipes.

For an estimated evaluation, friction losses must be multiplied for:

- 0,8 for new rolled steel pipes
- 1,25 for slightly rusted steel pipes
- 0,7 for aluminium pipes
- 0,65 for PVC pipes
- 1,25 for asbestos cement pipes

Q = Capacity
v = Velocity of water
d = Diameter of pipe
h = Friction loss

Notes: Les valeurs doivent s'entendre pour tuyaux en fonte, lisses à l'intérieur.

Pour une évaluation approximative, les pertes de charge doivent être multipliées par:

- 0,8 pour tuyaux laminés nouveaux en acier
- 1,25 pour tuyaux légèrement rouillés en acier
- 0,7 pour tuyaux en aluminium
- 0,65 pour tuyaux en PVC
- 1,25 pour tuyaux en fibro-ciment

Q = Débit
v = Vitesse de l'eau
d = Diamètre du tuyau
h = Perte de charge

Note: I valori sopra indicati s'intendono per tubi lisci in ghisa.

Per una valutazione di massima, le perdite di carico devono essere moltiplicate per:

- 0,8 per tubi di acciaio laminati nuovi
- 1,25 per tubi di acciaio leggermente arrugginiti
- 0,7 per tubi di alluminio
- 0,65 per tubi in PVC
- 1,25 per tubi in fibro-cemento

Q = portata
v = velocità dell'acqua
d = diametro del tubo
h = perdita di carico

Motori trifase a 2 Poli / 50 Hz / Three-phase motors 2 Poles / 50 Hz / Moteurs triphasés à 2 Pôles / 50 Hz																
Motore tipo Motor type Moteur type	Potenza motore Motor power Puiss. moteur		Temperatura max acqua Max water temperature Temperature max eau	Min. velocità di raffreddamento Min. cooling speed	Min. vitesse de refroidissement	Max avviamenti/ora Starts / hour max Max démarrages / heure	Giri al minuto Revolutions per minute Tours minute	Rendimento Efficiency Rendement		Fattore di potenza Power factor Facteur de puissance		Corrente nominale Nominal current Intensité nominale		Avviamento Starting Démarrage		
	[kW]	[HP]	[°C]	[m/s]	[No.]	[n ⁻¹]	η [%]		$\cos \varphi$		I_N [A]		$\frac{Ma}{Mn}$	$\frac{Ia}{In}$		
							3/4	4/4	3/4	4/4	A pieno carico Fully loaded A pleine charge	A vuoto Not loaded A vide		Diretto Direct Direct		Stella- triangolo Star- delta Etoile- triangle
					(1)	400	400	400	400	400	400	400	400	400	400	400
																
MACW65/3A	4	5,5	40	0,5	20	2910	77,5	78,5	0,706	0,77	9,5	5,4	1	4,35	1,45	3,05
MACW67/3A	5,5	7,5	40	0,5	20	2890	79,6	79	0,772	0,815	12,3	5,9	0,9	4	1,35	2,80
MACW610/3A	7,5	10	40	0,5	20	2905	79,2	80,5	0,768	0,81	16,6	7,7	1	4,45	1,50	3,10
MACW612/3A	9,2	12,5	40	0,5	20	2900	78,3	81	0,724	0,79	20,7	10,4	0,9	4,2	1,40	2,95
MACW615/3A	11	15	40	0,5	20	2890	81,5	80,7	0,690	0,775	25,4	15,2	1,4	4,75	1,60	3,30
MACW617/3A	13	17,5	40	0,5	20	2890	81,7	81,0	0,700	0,780	29,7	17,4	1,3	4,75	1,60	3,30
MACW620/3A	15	20	40	0,5	20	2880	82,3	81,5	0,725	0,800	33,2	17,4	1	4,2	1,40	2,95
MACW625/3A	18,5	25	35	0,5	20	2875	83,7	83	0,746	0,8	40,2	21,1	1,5	4,8	1,60	3,35
MACW630/3A	22	30	35	0,5	20	2870	84,2	83	0,751	0,82	46,6	23,2	1,5	4,9	1,65	3,45
MACW635/3A	26	35	35	0,5	20	2880	85,4	84	0,725	0,8	55,8	29,9	1,7	5,25	1,75	3,65
MACW640/3A	30	40	35	0,5	20	2870	85,4	83,5	0,77	0,83	62,5	28,7	1,3	4,6	1,55	3,20
MACW650/3A	37	50	30	0,5	20	2860	85,2	83,5	0,776	0,835	76,6	34,9	1,3	4,55	1,50	3,20

Motori trifase a 2 Poli / 50 Hz / Three-phase motors 2 Poles / 50 Hz / Moteurs triphasés à 2 Pôles / 50 Hz																
Motore tipo Motor type Moteur type	Potenza motore Motor power Puiss. moteur		Temperatura max acqua Max water temperature Température max eau	Min. velocità di raffreddamento Min. cooling speed Min. vitesse de refroidissement	Max avviamenti/ora Starts / hour max Max démarrages / heure	Giri al minuto Revolutions per minute Tours minute	Rendimento Efficiency Rendement		Fattore di potenza Power factor Facteur de puissance		Corrente nominale Nominal current Intensité nominale		Avviamento Starting Démarrage			
	[kW]	[HP]	[°C]	[m/s]	[No.]	[n ⁻¹]	3/4	4/4	3/4	4/4	A pieno carico Fully loaded A pleine charge	A vuoto Not loaded A vide	Diretto Direct		Stella- triangolo Star- delta Etoile- triangle	Statorico Statoriq ue
						(1)	400	400	400	400	400	400	400	400	400	400



MACW65/3B	4	5,5	45	0,5	20	2910	79,7	80	0,701	0,800	9,2	5	1	4,4	1,45	3,10
MACW67/3B	5,5	7,5	45	0,5	20	2910	80,9	81	0,756	0,815	12	5,6	0,9	4,15	1,40	2,90
MACW610/3B	7,5	10	45	0,5	20	2905	82,6	81,5	0,772	0,82	16,2	6,7	1	3,4	1,15	2,40
MACW612/3B	9,2	12,5	45	0,5	20	2900	83,9	82,5	0,787	0,83	19,4	7,4	1	3,4	1,15	2,40
MACW615/3B	11	15	45	0,5	20	2900	84,4	83	0,76	0,82	23,3	9,9	1,4	3,8	1,25	2,65
MACW617/3B	13	17,5	45	0,5	20	2900	84,2	84	0,735	0,805	27,7	13,7	1,3	4,75	1,60	3,30
MACW620/3B	15	20	45	0,5	20	2900	84,8	84	0,761	0,82	31,4	14,4	1,5	4,4	1,45	3,10
MACW625/3B	18,5	25	40	0,5	20	2880	84,4	84	0,743	0,8	39,8	19,5	1,5	4,2	1,40	2,95
MACW630/3B	22	30	40	0,5	20	2895	84,9	84,5	0,703	0,800	48	27	1,7	5,5	1,85	3,85
MACW635/3B	26	35	40	0,5	20	2880	85,7	85	0,759	0,815	54,2	25,1	1,7	4,4	1,45	3,10
MACW640/3B	30	40	40	0,5	20	2885	85,7	85	0,745	0,81	63	30,8	1,3	4,75	1,60	3,30
MACW650/3B	37	50	35	0,5	20	2875	85,5	84,5	0,734	0,805	78,5	40,7	1,6	5,1	1,70	3,55
MACW660/3B	45	60	35	0,5	15	2855	84,3	82,5	0,749	0,815	96,3	48,8	1,5	4,65	1,55	3,25
MACW840	30	40	30	0,2	10	2900	83,3	82,6	0,825	0,860	61,0	20,2	1,8	5,5	1,85	3,85
MACW850	37	50	30	0,2	10	2910	84,5	84,6	0,775	0,825	76,2	32,4	1,8	5,9	1,95	4,15
MACW860	45	60	30	0,2	10	2905	85,2	84,8	0,785	0,830	91,9	37,4	1,9	5,85	1,95	4,10
MACW870	51	70	30	0,2	8	2910	86,5	85,9	0,800	0,845	101,1	40,1	1,9	6	2,00	4,20
MACW880	59	80	30	0,5	8	2915	87,2	86,8	0,790	0,840	116,7	48,5	2	6,2	2,05	4,35
MACW890	66	90	30	0,5	8	2905	87,1	86,6	0,785	0,840	131,2	56,6	2	6,1	2,05	4,25
MACW8100	75	100	30	0,5	8	2895	87,5	86,6	0,815	0,860	145,4	54,4	2	5,9	1,95	4,15
MACW8125	92	125	30	0,5	6	2900	87,8	86,9	0,800	0,850	179,2	73,9	2,1	6,3	2,10	4,40
MACW8150	110	150	30	0,5	6	2895	87,8	86,9	0,805	0,855	213,8	86,8	1,9	6	2,0	4,2
MACW10100/1A	75	100	25	0,5	6	2925	86,6	85,9	0,845	0,865	145,5	41,7	1,4	6,1	2,05	4,25
MACW10125/1A	92	125	25	0,5	6	2925	87,3	87,0	0,835	0,860	177,2	52,6	1,6	6,7	2,25	4,70
MACW10150/1A	110	150	25	0,5	6	2930	88,2	87,8	0,830	0,860	209,7	61,1	1,5	6,3	2,10	4,40
MACW10180/1A	132	180	25	0,5	6	2930	88,4	87,9	0,830	0,860	251,1	81,8	1,6	6,6	-	4,60
MACW10200/1A	150	200	25	0,5	6	2930	88,8	88,4	0,825	0,860	284,3	83,4	1,7	6,7	-	4,70
MACW10220/1A	165	220	25	0,5	6	2930	88,6	88,3	0,810	0,850	317,5	112,3	1,7	6,9	-	4,85
MACW10250/1A	185	250	25	0,5	6	2935	88,6	88,4	0,795	0,840	358,5	140	1,6	6,7	-	4,70
MACW12230/1A	170	230	25	0,5	5	2955	89	89	0,8	0,845	327	96	1,3	5,5	-	3,85
MACW12260/1A	190	260	25	0,5	5	2955	89,5	89,4	0,81	0,850	360	111,2	1,2	5	-	3,50
MACW12300/1C	220	300	25	0,5	5	2940	89,2	89,3	0,865	0,860	413,2	95,0	1,3	4,8	-	3,35
MACW12340/1C	250	340	25	0,5	5	2935	89,2	89,1	0,86	0,86	470,7	105,0	1,3	4,5	-	3,15
MACW12400/1C	300	400	25	0,5	5	2930	88,9	89,0	0,835	0,870	558,2	160,0	1,5	4,6	-	3,20
MACW12475/1C	350	475	25	0,5	5	2940	89,2	89,0	0,820	0,845	670,4	184,0	1,4	4,8	-	3,35
MACW12540/1C	400	540	25	0,5	5	2920	89,0	88,7	0,845	0,865	752,6	205,0	1,4	4,3	-	3,00
MW14300	220	300	25	0,3	3	2955	88,1	88,2	0,850	0,870	414,1	120,0	1,5	6,85	-	4,80
MW14330	240	330	25	0,3	3	2955	88,6	87,8	0,845	0,865	453,4	167,0	1,8	7,5	-	5,25
MW14380	280	380	25	0,3	3	2955	88,5	89,0	0,846	0,868	522,8	161,0	1,6	7	-	4,90
MW14430	315	430	25	0,3	3	2980	89,0	89,2	0,850	0,875	590,0	193,0	1,8	7,2	-	5
MW14460	340	460	25	0,3	3	2955	88,6	88,2	0,850	0,865	642,2	228,0	1,6	6,8	-	4,75
MW14500	370	500	25	0,3	3	2950	88,6	88,9	0,806	0,838	715,7	290,0	1,8	7,5	-	5,25
MW14540	400	540	25	0,3	3	2945	89,0	88,0	0,790	0,815	804,0	206,0	1,8	7,5	-	5,25
MW14600	440	600	25	0,3	3	2950	89,0	88,0	0,825	0,840	858,0	254,0	1,8	7,5	-	5,25

Ma = Starting torque
Mn = Nominal couple
Ia = Starting current
In = Nominal current

Direction of rotation = Left (anti-clockwise) viewed from shaft projection side

(1) = Equally distributed

To supply voltages and admitted variations see the chapter: Motor general notes

Ma = Couple au démarrage
Mn = Couple nominale
Ia = Intensité au démarrage
In = Intensité nominale

Sens de rotation = Gauche (antioraire) vu du côté bout d'arbre

(1) = Uniformement repartis

Pour les tensions d'alimentation et les variations admises voir le chapitre: Remarques générales moteur

Ma = Coppia di avviamento
Mn = Coppia nominale
Ia = Corrente di avviamento
In = Corrente nominale

Senso di rotazione = Sinistro (antiorario) visto lato sporgenza albero

(1) = Equamente ripartiti

Per le tensioni di alimentazione e le variazioni ammesse vedere il capitolo: Note generali motore

Single-phase and three-phase motors 2 Pole / 50 Hz - Overall dimensions and weights
 Moteurs monophasés et triphasés 2 Pôles / 50 Hz - Dimensions d'encombrement et poids
 Motori monofase e trifase a 2 Poli / 50 Hz - Dimensioni di ingombro e pesi

Motor type Moteur type Motore tipo	Coupling flange/Bride d'accouplement Flangia accoppiamento	Motor weight/Poids moteur Peso motore	L	Ø E	S	Axial load Charge axiale Carico assiale	Length A Longueur A Lunghezza A	Cables outlet Sortie des câbles Uscita cavi														
								Cross section [mm²] Section en [mm²] Sezione in [mm²]														
								Starting Démarrage Avviamento														
								Direct Direct Diretto					Star-delta Etoile-triangle Stella-triangolo									
[kg]	[mm]	[N]	[m]	230	230 - 400	400	400 - 700	415	500	230 / 400	400 / 700											
MACW65/3A	NEMA 6"	34,6	570	143	73	30000	3,5	3x(1x4) (C.C.:6)	6x(1x2,5) (C.C.:7)	3x(1x2,5) (C.C.:8)	6x(1x2,5) (C.C.:9)	3x(1x2,5) (C.C.:5)	3x(1x2,5) (C.C.:4)	6x(1x2,5) (C.C.:7)	6x(1x2,5) (C.C.:9)							
MACW67/3A	NEMA 6"	39,6	615	143	73	30000	3,5	3x(1x4) (C.C.:6)	6x(1x2,5) (C.C.:7)	3x(1x2,5) (C.C.:8)	6x(1x2,5) (C.C.:9)	3x(1x2,5) (C.C.:5)	3x(1x2,5) (C.C.:4)	6x(1x2,5) (C.C.:7)	6x(1x2,5) (C.C.:9)							
MACW610/3A	NEMA 6"	44,4	670	143	73	30000	3,5	3x(1x4) (C.C.:6)	6x(1x2,5) (C.C.:7)	3x(1x2,5) (C.C.:8)	6x(1x2,5) (C.C.:9)	3x(1x2,5) (C.C.:5)	3x(1x2,5) (C.C.:4)	6x(1x2,5) (C.C.:7)	6x(1x2,5) (C.C.:9)							
MACW612/3A	NEMA 6"	47,7	700	143	73	30000	3,5	3x(1x4) (C.C.:6)	6x(1x2,5) (C.C.:7)	3x(1x2,5) (C.C.:8)	6x(1x2,5) (C.C.:9)	3x(1x2,5) (C.C.:5)	3x(1x2,5) (C.C.:4)	6x(1x2,5) (C.C.:7)	6x(1x2,5) (C.C.:9)							
MACW615/3A	NEMA 6"	52	715	143	73	30000	3,5	3x(1x4) (C.C.:6)	6x(1x2,5) (C.C.:7)	3x(1x2,5) (C.C.:8)	6x(1x2,5) (C.C.:9)	3x(1x2,5) (C.C.:5)	3x(1x2,5) (C.C.:4)	6x(1x2,5) (C.C.:7)	6x(1x2,5) (C.C.:9)							
MACW617/3A	NEMA 6"	56	750	143	73	30000	3,5	3x(1x6) (C.C.:6)	6x(1x4) (C.C.:7)	3x(1x4) (C.C.:8)	6x(1x4) (C.C.:9)	3x(1x4) (C.C.:5)	3x(1x4) (C.C.:4)	6x(1x4) (C.C.:7)	6x(1x4) (C.C.:9)							
MACW620/3A	NEMA 6"	59,8	790	143	73	30000	3,5	3x(1x6) (C.C.:6)	6x(1x4) (C.C.:7)	3x(1x4) (C.C.:8)	6x(1x4) (C.C.:9)	3x(1x4) (C.C.:5)	3x(1x4) (C.C.:4)	6x(1x4) (C.C.:7)	6x(1x4) (C.C.:9)							
MACW625/3A	NEMA 6"	64,2	830	143	73	30000	3,5	3x(1x6) (C.C.:6)	6x(1x4) (C.C.:7)	3x(1x4) (C.C.:8)	6x(1x4) (C.C.:9)	3x(1x4) (C.C.:5)	3x(1x4) (C.C.:4)	6x(1x4) (C.C.:7)	6x(1x4) (C.C.:9)							
MACW630/3A	NEMA 6"	74,5	920	143	73	30000	3,5	3x(1x10) (C.C.:6)	6x(1x4) (C.C.:7)	3x(1x4) (C.C.:8)	6x(1x4) (C.C.:9)	3x(1x4) (C.C.:5)	3x(1x4) (C.C.:4)	6x(1x4) (C.C.:7)	6x(1x4) (C.C.:9)							
MACW635/3A	NEMA 6"	89,3	1055	143	73	30000	3,5	3x(1x10) (C.C.:6)	6x(1x6) (C.C.:7)	3x(1x6) (C.C.:8)	6x(1x4) (C.C.:9)	3x(1x6) (C.C.:5)	3x(1x6) (C.C.:4)	6x(1x6) (C.C.:7)	6x(1x4) (C.C.:9)							
MACW640/3A	NEMA 6"	101,9	1165	143	73	30000	3,5	3x(1x10) (C.C.:6)	6x(1x6) (C.C.:7)	3x(1x6) (C.C.:8)	6x(1x4) (C.C.:9)	3x(1x6) (C.C.:5)	3x(1x6) (C.C.:4)	6x(1x6) (C.C.:7)	6x(1x4) (C.C.:9)							
MACW650/3A	NEMA 6"	111	1245	143	73	30000	4,5	-	6x(1x10) (C.C.:7)	3x(1x10) (C.C.:8)	6x(1x6) (C.C.:9)	3x(1x10) (C.C.:5)	3x(1x10) (C.C.:4)	6x(1x10) (C.C.:7)	6x(1x6) (C.C.:9)							
MACW65/3B	NEMA 6"	45,6	597	143	73	45000	3,5	3x(1x4) (C.C.:6)	6x(1x2,5) (C.C.:7)	3x(1x2,5) (C.C.:8)	6x(1x2,5) (C.C.:9)	3x(1x2,5) (C.C.:5)	3x(1x2,5) (C.C.:4)	6x(1x2,5) (C.C.:7)	6x(1x2,5) (C.C.:9)							
MACW67/3B	NEMA 6"	51	642	143	73	45000	3,5	3x(1x4) (C.C.:6)	6x(1x2,5) (C.C.:7)	3x(1x2,5) (C.C.:8)	6x(1x2,5) (C.C.:9)	3x(1x2,5) (C.C.:5)	3x(1x2,5) (C.C.:4)	6x(1x2,5) (C.C.:7)	6x(1x2,5) (C.C.:9)							
MACW610/3B	NEMA 6"	56,8	702	143	73	45000	3,5	3x(1x4) (C.C.:6)	6x(1x2,5) (C.C.:7)	3x(1x2,5) (C.C.:8)	6x(1x2,5) (C.C.:9)	3x(1x2,5) (C.C.:5)	3x(1x2,5) (C.C.:4)	6x(1x2,5) (C.C.:7)	6x(1x2,5) (C.C.:9)							
MACW612/3B	NEMA 6"	61	752	143	73	45000	3,5	3x(1x4) (C.C.:6)	6x(1x2,5) (C.C.:7)	3x(1x2,5) (C.C.:8)	6x(1x2,5) (C.C.:9)	3x(1x2,5) (C.C.:5)	3x(1x2,5) (C.C.:4)	6x(1x2,5) (C.C.:7)	6x(1x2,5) (C.C.:9)							
MACW615/3B	NEMA 6"	66	792	143	73	45000	3,5	3x(1x4) (C.C.:6)	6x(1x2,5) (C.C.:7)	3x(1x2,5) (C.C.:8)	6x(1x2,5) (C.C.:9)	3x(1x2,5) (C.C.:5)	3x(1x2,5) (C.C.:4)	6x(1x2,5) (C.C.:7)	6x(1x2,5) (C.C.:9)							
MACW617/3B	NEMA 6"	70,7	832	143	73	45000	3,5	3x(1x6) (C.C.:6)	6x(1x4) (C.C.:7)	3x(1x4) (C.C.:8)	6x(1x4) (C.C.:9)	3x(1x4) (C.C.:5)	3x(1x4) (C.C.:4)	6x(1x4) (C.C.:7)	6x(1x4) (C.C.:9)							
MACW620/3B	NEMA 6"	75,4	877	143	73	45000	3,5	3x(1x6) (C.C.:6)	6x(1x4) (C.C.:7)	3x(1x4) (C.C.:8)	6x(1x4) (C.C.:9)	3x(1x4) (C.C.:5)	3x(1x4) (C.C.:4)	6x(1x4) (C.C.:7)	6x(1x4) (C.C.:9)							
MACW625/3B	NEMA 6"	80,4	922	143	73	45000	3,5	3x(1x6) (C.C.:6)	6x(1x4) (C.C.:7)	3x(1x4) (C.C.:8)	6x(1x4) (C.C.:9)	3x(1x4) (C.C.:5)	3x(1x4) (C.C.:4)	6x(1x4) (C.C.:7)	6x(1x4) (C.C.:9)							
MACW630/3B	NEMA 6"	92,5	1022	143	73	45000	3,5	3x(1x10) (C.C.:6)	6x(1x4) (C.C.:7)	3x(1x4) (C.C.:8)	6x(1x4) (C.C.:9)	3x(1x4) (C.C.:5)	3x(1x4) (C.C.:4)	6x(1x4) (C.C.:7)	6x(1x4) (C.C.:9)							
MACW635/3B	NEMA 6"	104	1132	143	73	45000	3,5	3x(1x10) (C.C.:6)	6x(1x6) (C.C.:7)	3x(1x6) (C.C.:8)	6x(1x4) (C.C.:9)	3x(1x6) (C.C.:5)	3x(1x6) (C.C.:4)	6x(1x6) (C.C.:7)	6x(1x4) (C.C.:9)							
MACW640/3B	NEMA 6"	111	1222	143	73	45000	3,5	3x(1x10) (C.C.:6)	6x(1x6) (C.C.:7)	3x(1x6) (C.C.:8)	6x(1x4) (C.C.:9)	3x(1x6) (C.C.:5)	3x(1x6) (C.C.:4)	6x(1x6) (C.C.:7)	6x(1x4) (C.C.:9)							
MACW650/3B	NEMA 6"	119	1282	143	73	45000	4,5	-	6x(1x10) (C.C.:7)	3x(1x10) (C.C.:8)	6x(1x6) (C.C.:9)	3x(1x10) (C.C.:5)	3x(1x10) (C.C.:4)	6x(1x10) (C.C.:7)	6x(1x6) (C.C.:9)							
MACW660/3B	NEMA 6"	123,3	1322	143	73	45000	4,5	-	6x(1x10) (C.C.:7)	3x(1x10) (C.C.:8)	6x(1x6) (C.C.:9)	3x(1x10) (C.C.:5)	3x(1x10) (C.C.:4)	6x(1x10) (C.C.:7)	6x(1x6) (C.C.:9)							

Single-phase and three-phase motors 2 Pole / 50 Hz - Overall dimensions and weights
 Moteurs monophasés et triphasés 2 Pôles / 50 Hz - Dimensions d'encombrement et poids
 Motori monofase e trifase a 2 Poli / 50 Hz - Dimensioni di ingombro e pesi

	Motor type Moteur type Motore tipo	Coupling flange Bride d'accouplement Flangia accoppiamento	Motor weight Poids moteur Peso motore	L	Ø E	S	Axial load Charge axiale Carico assiale	Length A Longueur A	Cables outlet Sortie des câbles Uscita cavi									
									Cross section [mm ²] Section en [mm ²] Sezione in [mm ²]							Starting Démarrage Avviamento		
									Direct Direct Diretto						Star-delta Etoile-triangle Stella-triangolo			
									230	230 - 400	400	400 - 700	415	500	230 / 400	400 / 700		
	MACW840	NEMA 8"	143	1060	191	101,5	50000	4	3x(1x16) (C.C.:6)	6x(1x16) (C.C.:7)	3x(1x16) (C.C.:8)	6x(1x16) (C.C.:9)	3x(1x16) (C.C.:5)	3x(1x16) (C.C.:4)	6x(1x16) (C.C.:7)	6x(1x16) (C.C.:9)		
	MACW850	NEMA 8"	155	1115	191	101,5	50000	4	3x(1x16) (C.C.:6)	6x(1x16) (C.C.:7)	3x(1x16) (C.C.:8)	6x(1x16) (C.C.:9)	3x(1x16) (C.C.:5)	3x(1x16) (C.C.:4)	6x(1x16) (C.C.:7)	6x(1x16) (C.C.:9)		
	MACW860	NEMA 8"	172	1195	191	101,5	50000	4	3x(1x16) (C.C.:6)	6x(1x16) (C.C.:7)	3x(1x16) (C.C.:8)	6x(1x16) (C.C.:9)	3x(1x16) (C.C.:5)	3x(1x16) (C.C.:4)	6x(1x16) (C.C.:7)	6x(1x16) (C.C.:9)		
	MACW870	NEMA 8"	192	1290	191	101,5	50000	4	3x(1x25) (C.C.:6)	6x(1x16) (C.C.:7)	3x(1x25) (C.C.:8)	6x(1x16) (C.C.:9)	3x(1x25) (C.C.:5)	3x(1x25) (C.C.:4)	6x(1x16) (C.C.:7)	6x(1x16) (C.C.:9)		
	MACW880	NEMA 8"	210	1395	191	101,5	50000	4	3x(1x25) (C.C.:6)	6x(1x16) (C.C.:7)	3x(1x25) (C.C.:8)	6x(1x16) (C.C.:9)	3x(1x25) (C.C.:5)	3x(1x25) (C.C.:4)	6x(1x16) (C.C.:7)	6x(1x16) (C.C.:9)		
	MACW890	NEMA 8"	219	1430	191	101,5	50000	4	3x(1x35) (C.C.:6)	6x(1x16) (C.C.:7)	3x(1x25) (C.C.:8)	6x(1x16) (C.C.:9)	3x(1x25) (C.C.:5)	3x(1x25) (C.C.:4)	6x(1x16) (C.C.:7)	6x(1x16) (C.C.:9)		
	MACW8100	NEMA 8"	235	1500	191	101,5	50000	4	3x(1x35) (C.C.:6)	6x(1x16) (C.C.:7)	3x(1x25) (C.C.:8)	6x(1x16) (C.C.:9)	3x(1x25) (C.C.:5)	3x(1x25) (C.C.:4)	6x(1x16) (C.C.:7)	6x(1x16) (C.C.:9)		
	MACW8125	NEMA 8"	265	1685	191	101,5	50000	4	-	-	3x(1x25) (C.C.:8)	6x(1x16) (C.C.:9)	3x(1x25) (C.C.:5)	3x(1x25) (C.C.:4)	-	6x(1x16) (C.C.:9)		
	MACW8150	NEMA 8"	283	1760	191	101,5	50000	4	-	-	3x(1x35) (C.C.:8)	6x(1x16) (C.C.:9)	3x(1x35) (C.C.:5)	3x(1x35) (C.C.:4)	-	6x(1x16) (C.C.:9)		
	MACW10100/1A	NEMA 8"	300	1406	242	101,5	70000	4	-	-	3x(1x25) (C.C.:8)	6x(1x16) (C.C.:9)	3x(1x25) (C.C.:5)	3x(1x25) (C.C.:4)	-	6x(1x16) (C.C.:9)		
	MACW10125/1A	NEMA 8"	338	1536	242	101,5	70000	4	-	-	3x(1x25) (C.C.:8)	6x(1x16) (C.C.:9)	3x(1x25) (C.C.:5)	3x(1x25) (C.C.:4)	-	6x(1x16) (C.C.:9)		
	MACW10150/1A	NEMA 8"	373	1641	242	101,5	70000	4	-	-	3x(1x50) (C.C.:8)	6x(1x25) (C.C.:9)	3x(1x50) (C.C.:5)	3x(1x50) (C.C.:4)	-	6x(1x25) (C.C.:9)		
	MACW10180/1A	NEMA 8"	408	1766	242	101,5	70000	4	-	-	3x(1x50) (C.C.:8)	6x(1x25) (C.C.:9)	3x(1x50) (C.C.:5)	3x(1x50) (C.C.:4)	-	-		
	MACW10200/1A	NEMA 8"	436	1866	242	101,5	70000	4	-	-	3x(1x50) (C.C.:8)	6x(1x25) (C.C.:9)	3x(1x50) (C.C.:5)	3x(1x50) (C.C.:4)	-	-		
	MACW10220/1A	NEMA 8"	466	2026	242	101,5	70000	4	-	-	3x(1x70) (C.C.:8)	6x(1x35) (C.C.:9)	3x(1x70) (C.C.:5)	3x(1x70) (C.C.:4)	-	-		
	MACW10250/1A	NEMA 8"	499	2126	242	101,5	70000	4	-	-	3x(1x70) (C.C.:8)	6x(1x35) (C.C.:9)	3x(1x70) (C.C.:5)	3x(1x70) (C.C.:4)	-	-		

Overall dimensions and weights
Dimensions d'encombrement et poids
Dimensioni di ingombro e pesi

	Motor type Moteur type Motore tipo	Coupling flange Bride d'accouplement Flangia accoppiamento	Motor weight Poids moteur Peso motore	L	Ø E	S	Axial load Charge axiale Carico assiale	Cables outlet / Sortie des câbles / Uscita cavi								
								Length A Longueur A Lunghezza A	Cross section [mm ²] Section en [mm ²] Sezione in [mm ²]				Starting Démarrage Avviamento			
									Direct Direct Diretto				Star-delta Etoile-triangle Stella-triangolo			
									230	230 - 400	400	400 - 700	415	500	230 / 400	400 / 700
	MACW12230/1A	12"	691	1958	290	76	80000	5	-	-	3x(1x95) (C.C.:8)	6x(1x70) (C.C.:9)	3x(1x95) (C.C.:5)	3x(1x95) (C.C.:4)	-	-
	MACW12260/1A	12"	759	2108	290	76	80000	5	-	-	3x(1x95) (C.C.:8)	6x(1x70) (C.C.:9)	3x(1x95) (C.C.:5)	3x(1x95) (C.C.:4)	-	-
	MACW12300/1C	12"	691	1958	290	76	80000	5	-	-	6x(1x70) (C.C.:8)	6x(1x70) (C.C.:9)	6x(1x70) (C.C.:5)	6x(1x70) (C.C.:4)	-	-
	MACW12340/1C	12"	759	2108	290	76	80000	5	-	-	6x(1x70) (C.C.:8)	6x(1x70) (C.C.:9)	6x(1x70) (C.C.:5)	6x(1x70) (C.C.:4)	-	-
	MACW12400/1C	12"	812	2258	290	76	80000	5	-	-	6x(1x70) (C.C.:8)	-	6x(1x70) (C.C.:5)	6x(1x70) (C.C.:4)	-	-
	MACW12475/1C	12"	837	2308	290	76	80000	5	-	-	6x(1x70) (C.C.:8)	-	6x(1x70) (C.C.:5)	6x(1x70) (C.C.:4)	-	-
	MACW12540/1C	12"	858	2358	290	76	80000	5	-	-	6x(1x70) (C.C.:8)	-	6x(1x70) (C.C.:5)	6x(1x70) (C.C.:4)	-	-
	MW14300	12"	812	1927	337	76	80000	5	-	-	6x(1x70) (C.C.:8)	-	6x(1x70) (C.C.:5)	6x(1x70) (C.C.:4)	-	-
	MW14330	12"	842	1982	337	76	80000	5	-	-	6x(1x70) (C.C.:8)	-	6x(1x70) (C.C.:5)	6x(1x70) (C.C.:4)	-	-
	MW14380	12"	881	2042	337	76	80000	5	-	-	6x(1x95) (C.C.:8)	-	6x(1x95) (C.C.:5)	6x(1x95) (C.C.:4)	-	-
	MW14430	12"	975	2192	337	76	80000	5	-	-	6x(1x95) (C.C.:8)	-	6x(1x95) (C.C.:5)	6x(1x95) (C.C.:4)	-	-
	MW14460	12"	1036	2292	337	76	80000	5	-	-	6x(1x95) (C.C.:8)	-	6x(1x95) (C.C.:5)	6x(1x95) (C.C.:4)	-	-
	MW14500	12"	1118	2412	337	76	80000	5	-	-	6x(1x95) (C.C.:8)	-	6x(1x95) (C.C.:5)	6x(1x95) (C.C.:4)	-	-
	MW14540	12"	1153	2462	337	76	80000	5	-	-	6x(1x95) (C.C.:8)	-	6x(1x95) (C.C.:5)	6x(1x95) (C.C.:4)	-	-
	MW14600	12"	1196	2512	337	76	80000	5	-	-	6x(1x95) (C.C.:8)	-	6x(1x95) (C.C.:5)	6x(1x95) (C.C.:4)	-	-
Section / Section / Sezione		F														
[mm ²]		[mm]														
	1 x 2.5	6,4														
	1 x 4	7,0														
	1 x 6	7,9														
	1 x 10	9,2														
	1 x 16	10,6														
	1 x 25	12,5														
	1 x 35	13,7														
	1 x 50	16,4														
	1 x 70	18,6														
1 x 95	21,7															

C.C = Motor manufacturing code

C.C = Code construction moteur

C.C = Codice costruttivo motore

Dynamic momentum of the wet end
Moment dynamique partie hydraulique
Momento dinamico parte idraulica

Standard construction <i>Exécution standard</i> Esecuzione standard		
Electric pump type <i>Electropompe type</i> Elettropompa tipo	J Wet <i>J Mouillé</i> J Bagnato	
	Single stage <i>Mono étagée</i> Monostadio	For each additional stage <i>Pour chaque étage en plus</i> Per ogni stadio in più
	J=1/4 PD ² [kgm²]	
E6RX30 (x 6")	0,000910	0,000730
E6RX37 (x 6")	0,000806	0,000624
E6RX47 (x 6")	0,000949	0,000767
E6SX50 (x 6")	0,00248	0,00187
E6SX55 (x 6")	0,00225	0,00164
E6SX64 (x 6")	0,00204	0,00143
E8PX65 (x 6" - 8")	0,004844	0,004384
E8PX95 (x 6" - 8")	0,006019	0,004976
E8PX135 (x 6" - 8")	0,005448	0,004980
E10PX200 (x 6")	0,01406	0,01394
E10PX200 (x 8" - 10")	0,0141	0,01393
E10PX200 (x 12" - 14")	0,01728	0,01405
E10PX250 (x 6")	0,01705	0,01693
E10PX250 (x 8" - 10")	0,01706	0,01689
E10PX250 (x 12" - 14")	0,02027	0,01704
E10PX315 (x 6")	0,02134	0,02122
E10PX315 (x 8" - 10")	0,02109	0,02092
E10PX315 (x 12" - 14")	0,02442	0,02119
E12PX430 (x 8" - 10")	0,04342	0,04093
E12PX430 (x 12" - 14")	0,04455	0,04093

Dynamic momentum of the motor
Moment dynamique moteur
Momento dinamico motore

Dynamic momentum of the motor <i>Moment dynamique moteur</i> Momento dinamico motore	
Motor type <i>Moteur type</i> Motore tipo	J=1/4 PD ² [kgm ²]
	
MACW65/3A	0,0029
MACW67/3A	0,0040
MACW610/3A	0,0054
MACW612/3A	0,0065
MACW615/3A	0,0068
MACW617/3A	0,0077
MACW620/3A	0,0086
MACW625/3A	0,0096
MACW630/3A	0,0120
MACW635/3A	0,0150
MACW640/3A	0,0180
MACW650/3A	0,0200

Dynamic momentum of the motor <i>Moment dynamique moteur</i> Momento dinamico motore	
Motor type <i>Moteur type</i> Motore tipo	J=1/4 PD ² [kgm ²]
	
MACW65/3B	0,0042
MACW67/3B	0,0053
MACW610/3B	0,0065
MACW612/3B	0,0077
MACW615/3B	0,0086
MACW617/3B	0,0096
MACW620/3B	0,0110
MACW625/3B	0,0120
MACW630/3B	0,0141
MACW635/3B	0,0163
MACW640/3B	0,0183
MACW650/3B	0,0195
MACW660/3B	0,0202

MACW840	0,0207
MACW850	0,0235
MACW860	0,0277
MACW870	0,0326
MACW880	0,0380
MACW890	0,0398
MACW8100	0,0434
MACW8125	0,0530
MACW8150	0,057
MACW10100/1A	0,0994
MACW10125/1A	0,1207
MACW10150/1A	0,1375
MACW10180/1A	0,1569
MACW10200/1A	0,1700
MACW10220/1A	0,1880
MACW10250/1A	0,2010
MACW12230/1A	0,339
MACW12260/1A	0,382
MACW12300/1C	0,339
MACW12340/1C	0,382
MACW12400/1C	0,41
MACW12475/1C	0,429
MACW12540/1C	0,442
MW14300	0,486
MW14330	0,51
MW14380	0,546
MW14430	0,631
MW14460	0,69
MW14500	0,76
MW14540	0,79
MW14600	0,82

Feeding cables
Câbles d'alimentation
Cavi di alimentazione

Calculation of cross-section
Calcul de la section
Calcolo della sezione

The choice of the feeding cable is made considering:

1. acceptable voltage drop
2. power loss in the cable
3. maximum current admitted by the cable.

Le choix du câble d'alimentation s'effectue sur la base:

1. de la chute de tension admissible
2. de la perte de puissance dans la longueur considérée
3. de l'intensité maximale admissible dans le câble.

La scelta del cavo di alimentazione si effettua sulla base:

1. della caduta di tensione ammissibile
2. della potenza dissipata lungo il cavo
3. della corrente massima ammissibile nel cavo.

1.1. Voltage drop ΔU [%] in three-wire cables (resistance only)
Chute de tension ΔU [%] pour câbles tripolaires (résistance seulement)
Caduta di tensione ΔU [%] per cavi tripolari (sola resistenza)

1.1.1. 3-phase motor with - *Moteur triphasé avec* - **Motore trifase con** :
Starting: direct, by statoric impedences, by autotransformer
Démarrage: direct, à impédances statoriques, avec auto-transformateur
Avviamento: diretto, a impedenze statoriche, con autotrasformatore

1 three-wire cable 3 x s
1 câble trois fils 3 x s
1 cavo tripolare 3 x s

$$\Delta U = \frac{I \cdot L \cdot \cos \varphi}{s \cdot 32,3} \times \frac{100}{U} : s = \frac{I \cdot L \cdot \cos \varphi}{\Delta U \cdot 32,3} \times \frac{100}{U}$$

1.1.2. 3-phase motor with - *Moteur triphasé avec* - **Motore trifase con** :
Starting: star-delta
Démarrage: étoile-triangle
Avviamento: stella-triangolo

2 three-wire cable 3 x s
2 câbles trois fils 3 x s
2 cavi tripolari 3 x s

$$\Delta U = \frac{I \cdot L \cdot \cos \varphi}{s \cdot 48,5} \times \frac{100}{U} : s = \frac{I \cdot L \cdot \cos \varphi}{\Delta U \cdot 48,5} \times \frac{100}{U}$$

1.1.3. Single-phase motor
Moteur monophasé
Motore monofase

1 three-wire cable 3 x s
1 câble trois fils 3 x s
1 cavo tripolare 3 x s

$$\Delta U = \frac{I \cdot L \cdot \cos \varphi}{s \cdot 28} \times \frac{100}{U} : s = \frac{I \cdot L \cdot \cos \varphi}{\Delta U \cdot 28} \times \frac{100}{U}$$

1.2. Voltage drop ΔU [%] in single-wire cables (resistance and reactance)
Chute de tension ΔU [%] pour câbles unipolaires (résistance et réactance)
Caduta di tensione ΔU [%] per cavi unipolari (resistenza e reattanza)

$$\Delta U = 1,73 \cdot I \cdot L \cdot (R \cdot \cos \varphi + X \cdot \sin \varphi) \cdot \frac{100}{U}$$

- 1.2.1. The voltage drop changes according to the resistance and the reactance induced by single-wires each other according to:
- the cables cross section
 - their respective position (single, paired, side by side)
 - their angular position (at 120° at 180°)

La chute de tension varie en fonction de la résistance et de la réactance d'induction causée par les conducteurs entre eux et en fonction de:

- la section des câbles
- la position entre eux (single, jumelés côte à côte)
- leur position angulaire (à 120° à 180°)

La caduta di tensione varia in funzione della resistenza e della reattanza induttiva esercitata reciprocamente dai singoli conduttori in funzione:

- della dimensione dei cavi
- della loro posizione reciproca (singoli, abbinati, affiancati)
- della loro disposizione angolare (a 120° a 180°)

1.3. For different supply voltages:

Pour tensions d'alimentation différentes:
Per tensioni di alimentazione diverse:

$$L_N = L \cdot \frac{U_N}{230} : L_N = L \cdot \frac{U_N}{400}$$

1.4. For different power factors:

Pour cosφ différents:
Per cosφ diversi:

$$L_N = L \cdot \frac{0,8}{\cos \varphi}$$

2.1 Power loss P_v along the feeding cables
Perte de puissance P_v le long des câbles d'alimentation
Perdita di potenza P_v lungo i cavi di alimentazione

$$P_v = I^2 \cdot \frac{L}{s \cdot 18,7} \text{ [W]}$$

I = Motor nominal current [A]
= *Intensité nominale du moteur [A]*
= **Assorbimento nominale del motore [A]**

R = Cable resistance [Ω /m]
= *Résistance et du câble [Ω /m]*
= **Resistenza del cavo [Ω /m]**

U_N = New voltage [V]
= *Nouvelle tension [V]*
= **Nuova tensione [V]**

L = Cable length [m]
= *Longueur du câble [m]*
= **Lunghezza del cavo [m]**

X = Inductive reactance [Ω /m]
= *Réactance d'induction [Ω /m]*
= **Reattanza induttiva [Ω /m]**

ΔU = Voltage drop [%]
= *Chute de tension [%]*
= **Caduta di tensione [%]**

L_N = New cable length [m]
= *Nouvelle longueur du câble [m]*
= **Nuova lunghezza cavo [m]**

U = Nominal voltage [V]
= *Tension nominale [V]*
= **Tensione nominale [V]**

s = Copper wire cross-section [mm^2]
= *Section du conducteur en cuivre [mm^2]*
= **Sezione del conduttore in rame [mm^2]**

cos φ = Full-load power factor (see table motors operating data)
= *Facteur de puissance à pleine charge (voir tableau caractéristiques moteurs)*
= **Fattore di potenza a pieno carico (vedi tabella caratteristiche motori)**

Cavi tripolari isolati in EPDM/EPR* 6" Tree-wire cables EPDM/EPR* 6" insulated Câbles tripolaires isolés en EPDM/EPR* 6"															
Sezione del cavo 3 x s Cable cross-section 3 x s Section du câble 3 x s	[mm ²]	1,5	2,5	4	6	10	16	25	35	50	70	95	120	150	185
I _{max} ammissibile I _{max} allowable I _{max} admissible	[A]	23	32	42	54	75	100	127	158	192	246	298	346	399	456
Temperatura max di esercizio Max. operating temperature Température maximum de service	[°C]	90	90	90	90	90	90	90	90	90	90	90	90	90	90

Per temperature diverse applicare il coefficiente moltiplicativo K: For different environmental temperatures apply the multiplication coefficient K: Pour des températures ambiantes différentes appliquer le coefficient multiplicatif K:											
Temperatura ambiente Ambient temperature Température ambiante	[°C]	10	15	20	25	30	35	40	45	50	
In aria libera In the open air A l'air libre	K	1,15	1,12	1,08	1,04	1	0,96	0,91	0,87	0,82	

If two 3-core cables, multiply the max. permitted current detailed in the chart by the coefficient:
2 with direct or stator starting (cables in parallel)
1,73 with star-delta starting

En utilisant deux câbles tripolaires, multiplier le courant maximum admissible du tableau par le coefficient:
2 pour démarrage direct ou par stator (câbles en parallèle)
1,73 pour démarrage étoile-triangle

N.B. Impiegando due cavi, moltiplicare la corrente massima ammissibile di tabella per il coefficiente:
2 con avviamento diretto o statorico (cavi in parallelo)
1,73 con avviamento stella-triangolo

* Cables in EPDM/EPR are certified for contact with drinking water in accordance with the following regulations: WRAS (Water Regulations Advisory Scheme) according to BS 6920; ACS (Attestation de Conformité Sanitaire) according to DGS/VS4 99/217 and DGS/VS4 2000/232; Ministerial Decree D.M. 174/04.

* Les câbles en EPDM/EPR sont certifiés au contact direct avec l'eau potable, conformément aux normes: WRAS (Water Regulations Advisory Scheme) suivant la BS 6920; ACS (Attestation de Conformité Sanitaire) suivant les circulaires DGS/VS4 99/217 et DGS/VS4 2000/232; D.M. 174/04.

* I cavi in EPDM/EPR sono certificati al contatto con l'acqua potabile, ai sensi delle normative: WRAS (Water Regulations Advisory Scheme) secondo la BS 6920; ACS (Attestation de Conformité Sanitaire) secondo le DGS/VS4 99/217 e DGS/VS4 2000/232; D.M. 174/04.

Cavi tripolari isolati in PVC 6" Tree-wire cables PVC 6" insulated Câbles tripolaires isolés en PVC 6"															
Sezione del cavo 3 x s Cable cross-section 3 x s Section du câble 3 x s	[mm ²]	1,5	2,5	4	6	10	16	25	35	50	70	95	120	150	185
I _{max} ammissibile I _{max} allowable I _{max} admissible	[A]	18,5	25	34	43	60	80	101	126	153	196	238	276	319	364
Temperatura max di esercizio Max. operating temperature Température maximum de service	[°C]	70	70	70	70	70	70	70	70	70	70	70	70	70	70
Per temperature diverse applicare il coefficiente moltiplicativo K: For different environmental temperatures apply the multiplication coefficient K: Pour des températures ambiantes différentes appliquer le coefficient multiplicatif K:															
Temperatura ambiente Ambient temperature Température ambiante	[°C]	10	15	20	25	30	35	40	45	50					
In aria libera In the open air A l'air libre	K	1,22	1,17	1,12	1,06	1	0,94	0,87	0,79	0,71					

If two 3-core cables, multiply the max. permitted current detailed in the chart by the coefficient:
2 with direct or stator starting (cables in parallel)
1,73 with star-delta starting

En utilisant deux câbles tripolaires, multiplier le courant maximum admissible du tableau par le coefficient:
2 pour démarrage direct ou par stator (câbles en parallèle)
1,73 pour démarrage étoile-triangle

**N.B. Impiegando due cavi, moltiplicare la corrente massima ammissibile di tabella per il coefficiente:
2 con avviamento diretto o statorico (cavi in parallelo)
1,73 con avviamento stella-triangolo**

Cavi unipolari isolati in EPDM/EPR* 6" Single-core cables isolated with EPDM/EPR* 6" Câbles unipolaires isolés en EPDM/EPR* 6"														
Sezione del cavo 1 x s Cable cross-section 1 x s Section du câble 1 x s	[mm ²]	2,5	4	6	10	16	25	35	50	70	95	120	150	185
I _{max} ammissibile I _{max} allowable I _{max} admissible	[A]	43	58	75	103	138	182	226	275	353	430	500	577	661
Temperatura max di esercizio Max. operating temperature Température maximum de service	[°C]	90	90	90	90	90	90	90	90	90	90	90	90	90
Per temperature diverse applicare il coefficiente moltiplicativo K: For different environmental temperatures apply the multiplication coefficient K: Pour des températures ambiantes différentes appliquer le coefficient multiplicatif K:														
Temperatura ambiente Ambient temperature Température ambiante	[°C]	10	15	20	25	30	35	40	45	50				
In aria libera In the open air A l'air libre	K	1,15	1,12	1,08	1,04	1	0,96	0,91	0,87	0,82				

If two 3-core cables, multiply the max. permitted current detailed in the chart by the coefficient:
2 with direct or stator starting (cables in parallel)
1,73 with star-delta starting

En utilisant deux câbles tripolaires, multiplier le courant maximum admissible du tableau par le coefficient:
2 pour démarrage direct ou par stator (câbles en parallèle)
1,73 pour démarrage étoile-triangle

N.B. Impiegando due cavi, moltiplicare la corrente massima ammissibile di tabella per il coefficiente:
2 con avviamento diretto o statorico (cavi in parallelo)
1,73 con avviamento stella-triangolo

* Cables in EPDM/EPR are certified for contact with drinking water in accordance with the following regulations: WRAS (Water Regulations Advisory Scheme) according to BS 6920; ACS (Attestation de Conformité Sanitaire) according to DGS/VS4 99/217 and DGS/VS4 2000/232; Ministerial Decree D.M. 174/04.

* Les câbles en EPDM/EPR sont certifiés au contact direct avec l'eau potable, conformément aux normes: WRAS (Water Regulations Advisory Scheme) suivant la BS 6920; ACS (Attestation de Conformité Sanitaire) suivant les circulaires DGS/VS4 99/217 et DGS/VS4 2000/232; D.M. 174/04.

* I cavi in EPDM/EPR sono certificati al contatto con l'acqua potabile, ai sensi delle normative: WRAS (Water Regulations Advisory Scheme) secondo la BS 6920; ACS (Attestation de Conformité Sanitaire) secondo le DGS/VS4 99/217 e DGS/VS4 2000/232; D.M. 174/04.

Cavi unipolari isolati in PVC 6" Single-core cables isolated with PVC 6" Câbles unipolaires isolés en PVC 6"														
Sezione del cavo 1 x s Cable cross-section 1 x s Section du câble 1 x s	[mm ²]	2,5	4	6	10	16	25	35	50	70	95	120	150	185
I _{max} ammissibile I _{max} allowable I _{max} admissible	[A]	26	35	46	63	85	114	143	174	225	275	321	372	427
Temperatura max di esercizio Max. operating temperature Température maximum de service	[°C]	70	70	70	70	70	70	70	70	70	70	70	70	70
Per temperature diverse applicare il coefficiente moltiplicativo K: For different environmental temperatures apply the multiplication coefficient K: Pour des températures ambiantes différentes appliquer le coefficient multiplicatif K:														
Temperatura ambiente Ambient temperature Température ambiante	[°C]	10	15	20	25	30	35	40	45	50				
In aria libera In the open air A l'air libre	K	1,22	1,17	1,12	1,06	1	0,94	0,87	0,79	0,71				

If two 3-core cables, multiply the max. permitted current detailed in the chart by the coefficient:
2 with direct or stator starting (cables in parallel)
1,73 with star-delta starting

*En utilisant deux câbles tripolaires, multiplier le courant maximum admissible du tableau par le coefficient:
2 pour démarrage direct ou par stator (câbles en parallèle)
1,73 pour démarrage étoilille-triangle*

**N.B. Impiegando due cavi, moltiplicare la corrente massima ammissibile di tabella per il coefficiente:
2 con avviamento diretto o statorico (cavi in parallelo)
1,73 con avviamento stella-triangolo**

Max admitted length
Longueur maxi admise
Lunghezze massime ammissibili

Max length [m] - EPDM/EPR or PVC three-pole power cables
Longueur maxi admise [m] - EPDM/EPR ou PVC three-pole power cables
Lunghezza MAX [m] - Cavo di alimentazione Tripolare EPDM/EPR o PVC
Direct or statoric starting - 3 cables Motor exit- 1 Cable with section (s) 3 x ...
Demarrage direct ou statorique - Sortie moteur 3 câbles - 1 Câble, section (s) 3 x ...
Avviamento diretto o statorico - Motore con uscita 3 cavi - 1 cavo di sezione (s) 3 x ...

I [A]	S [mm ²]														
	1,5	2,5	4	6	10	16	25	35	50	70	95	120	150	185	
2,5	249	413													
5	124	206	331	493											
7,5	83	138	221	329	560										
10	62	103	165	247	420										
15	41	69	110	164	280	434									
20	31	52	83	123	210	326	491								
25		41	66	99	168	261	393	535							
30		34	55	82	140	217	327	446							
40			41	62	105	163	246	334	462						
50				49	84	130	196	267	370	498					
60					70	109	164	223	308	415	516				
70					60	93	140	191	264	356	442	534			
80						81	123	167	231	311	387	468	546		
90						72	109	149	205	277	344	416	486	554	
100						65	98	134	185	249	309	374	437	498	
120							82	111	154	208	258	312	364	415	
140								96	132	178	221	267	312	356	
160									116	156	193	234	273	311	
180									103	138	172	208	243	277	
200										125	155	187	219	249	
220										113	141	170	199	226	
240										104	129	156	182	208	
260											119	144	168	192	
280											110	134	156	178	
300												125	146	166	
320													117	137	156

* The EPDM cables are fit for contact with drinking water, certified by WRAS (Water Regulations Advisory Scheme) in compliance with standard BS 6920.

Make sure that the current considered is effectively that absorbed by the motor in the real operating conditions.

The lengths given in boldface type refer solely to cables in EPDM/EPR

The cable lengths refer to 30°C ambient temperature; installation in air; 400[V] 50[Hz] power supply; cosφ = 0.8 and 3% permissible voltage drop.

Check the selection parameters carefully if the conditions are different (see "Calculation of cross-section" and "Maximum permitted current")

Make sure that the section of the riser cable is the same as the section of the motor output cable, or larger.

If the conditions are different, please contact our sales organization.

* Les câbles en EPDM sont indiqués pour le contact avec l'eau potable, certifiés par le WRAS (Water Regulations Advisory Scheme) conformément à la réglementation BS 6920.

Vérifier que le courant considéré soit effectivement celui absorbé par le moteur dans les conditions réelles de service.

Les longueurs marquées en caractères gras se réfèrent aux câbles en EPDM/EPR seulement

Les longueurs des câbles se réfèrent à une température ambiante de 30°C; pose à l'air libre; alimentation 400[V] 50[Hz]; cosφ = 0,8 et chute de tension admissible = 3%. En cas de conditions différentes, vérifier soigneusement les paramètres de sélection (voir "Calcul de la section" et "Courant maximum admissible").

Vérifier que la section sélectionnée pour le câble de remontée soit supérieure ou égale à la section du câble de sortie moteur.

En cas de conditions différentes, contacter notre service commercial

* I cavi in EPDM sono idonei al contatto con l'acqua potabile, certificati dal WRAS (Water Regulations Advisory Scheme) secondo la normativa BS 6920

Assicurarsi che la corrente considerata sia effettivamente quella assorbita dal motore nelle condizioni reali d'esercizio.

Le lunghezze contrassegnate in grassetto sono riferite solo ai cavi in EPDM/EPR.

Le lunghezze dei cavi sono riferite ad una temperatura ambiente di 30°C; installazione in aria; alimentazione 400[V] 50[Hz]; cosφ = 0,8 e caduta di tensione ammessa = 3%.

Per condizioni diverse, verificare accuratamente i parametri di selezione (vedi "Calcolo della sezione" e "Corrente massima ammissibile").

Assicurarsi che la sezione selezionata per il cavo di risalita sia maggiore o uguale alla sezione del cavo d'uscita motore.

Per condizioni diverse, interpellare la sede o la rete di vendita.

Max admitted length
Longueur maxi admise
 Lunghezze massime ammissibili

Max length [m] - EPDM/EPR or PVC Single-pole power cables - Longuer maxi admise [m] - EPDM/EPR ou PVC Unipolaires power cables-
Lunghezza MAX [m] - Cavi di alimentazione unipolari EPDM/EPR o PVC
 Direct or statoric starting - 3 cables Motor exit / *Demarrage direct ou statorique- Sortie moteur 3 câbles* / **Avviamento diretto o statorico- Motore con uscita 3 cavi**
 3 Cables wit section (s) 1 x ... / *3 Câble, section (s) 1 x ...* / **3 cavi di sezione (s) 1 x ...**
 6 Cable cross-section (s) 1 x ... / *6 Câble de section (s) 1 x ...* / **6 cavi di sezione (s) 1 x ...**

[A]	DN _{max}	S [mm ²]												
		2.5	4	6	10	16	25	35	50	70	95	120	150	185
10	4"	102	162	239	400									
	6"	101	161	237	395	597								
	8"-9"-10"	101	161	237	394	594								
	12"	101	160	236	391	588								
15	4"	68	108	159	267	405	595							
	6"	68	107	158	264	398	580							
	8"-9"-10"	68	107	158	263	396	576							
	12"	67	107	157	261	392	567							
20	4"	51	81	120	200	304	446	595						
	6"	51	81	119	198	298	435	575						
	8"-9"-10"	51	80	119	197	297	432	570						
	12"	51	80	118	196	294	425	558						
25	4"	41	65	96	160	243	357	476						
	6"	41	64	95	158	239	345	460						
	8"-9"-10"	41	64	95	158	238	346	456						
	12"	40	64	94	157	235	340	447	585					
30	4"	34	54	80	133	202	297	397	530					
	6"	34	54	79	132	199	290	384	507					
	8"-9"-10"	34	54	79	131	198	288	380	502					
	12"	34	53	79	130	196	284	372	488					
40	4"	25	40	60	100	152	223	297	398	518				
	6"	25	40	59	99	149	218	288	380	489	589			
	8"-9"-10"	25	40	59	99	149	216	285	376	482	579			
	12"	25	40	59	98	147	213	279	368	465	554			
50	4"	32	48	80	121	178	238	318	414	505	597			
	6"	32	47	79	119	174	230	304	391	471	550			
	8"-9"-10"	32	47	79	119	173	228	301	386	463	539			
	12"	32	47	78	118	170	223	293	372	443	513	578		
60	4"	40	67	101	149	198	265	345	421	497	573			
	6"	40	66	99	145	192	254	326	393	458	522	582		
	8"-9"-10"	40	66	99	144	190	251	321	386	449	510	567		
	12"	39	65	98	142	186	244	310	370	427	482	533		
70	4"	34	57	87	127	170	227	296	361	426	491	554		
	6"	34	56	85	124	164	217	280	337	393	447	499		
	8"-9"-10"	34	56	85	124	163	215	275	331	385	437	486		
	12"	34	56	84	122	160	209	266	317	366	413	457		
80	4"	50	78	112	149	199	259	316	373	430	485			
	6"	49	75	109	144	190	245	295	344	391	437			
	8"-9"-10"	49	74	108	143	188	241	289	337	382	426			
	12"	49	73	106	140	183	233	277	320	361	400			
90	4"	44	67	99	132	177	230	281	332	382	431			
	6"	44	66	97	128	169	217	262	306	348	388			
	8"-9"-10"	44	66	96	127	167	214	257	299	340	378			
	12"	43	65	95	124	163	207	246	285	321	355			
100	4"	40	61	89	119	159	207	253	298	344	388			
	6"	40	60	87	115	152	196	236	275	313	349			
	8"-9"-10"	39	59	86	114	150	193	232	270	306	340			
	12"	39	59	85	112	146	186	222	256	289	320			
120	4"	51	74	99	133	173	210	249	286	323				
	6"	50	73	96	127	163	196	229	261	291				
	8"-9"-10"	50	72	95	125	161	193	225	255	284				
	12"	49	71	93	122	155	185	214	241	266				
140	4"	64	85	114	148	180	213	246	277					
	6"	62	82	109	140	168	196	224	250					
	8"-9"-10"	62	81	107	138	165	193	219	243					
	12"	61	80	104	133	158	183	207	228					
160	4"	56	74	99	129	158	187	215	242					
	6"	54	72	95	122	147	172	196	218					
	8"-9"-10"	54	71	94	121	145	168	191	213					
	12"	53	70	91	116	139	160	181	200					
180	4"	50	66	89	115	140	166	191	216					
	6"	48	64	85	109	131	153	174	194					
	8"-9"-10"	48	63	84	107	129	150	170	189					
	12"	47	62	81	103	123	142	161	178					
200	4"	58	80	104	126	148	172	194						
	6"	58	76	98	118	138	157	175						
	8"-9"-10"	57	75	96	116	135	153	170						
	12"	56	73	93	111	128	145	160						
220	4"	54	72	94	115	136	156	176						
	6"	52	69	89	107	125	142	159						
	8"-9"-10"	52	68	88	105	123	139	155						
	12"	51	66	85	101	117	131	145						
240	4"	66	86	105	124	143	162							
	6"	63	82	98	115	130	146							
	8"-9"-10"	63	80	96	112	127	142							
	12"	61	78	92	107	120	133							
260	4"	81	80	97	115	132	149							
	6"	59	75	91	106	120	134							
	8"-9"-10"	58	74	89	104	116	131							
	12"	56	72	85	99	111	123							
280	4"	74	90	107	123	139								
	6"	70	84	98	112	125								
	8"-9"-10"	69	83	96	109	122								
	12"	66	79	92	103	114								
300	4"	89	84	99	115	129								
	6"	85	79	92	104	116								
	8"-9"-10"	84	77	90	102	113								
	12"	82	74	85	96	107								
320	4"	65	79	93	107	121								
	6"	61	74	86	98	109								
	8"-9"-10"	60	72	84	96	106								
	12"	58	69	80	90	100								

Make sure that the current considered is effectively that absorbed by the motor in the real operating conditions.
 The lengths given in boldface type refer solely to cables in EPDM/EPR

The cable lengths refer to 30°C ambient temperature; installation in air; 400V [50Hz] power supply; cosφ = 0.8 and 3% permissible voltage drop. Check the selection parameters carefully if the conditions are different (see "Calculation of cross-section" and "Maximum permitted current")

Make sure that the section of the riser cable is the same as the section of the motor output cable, or larger.
 If the conditions are different, please contact our sales organization.

* The EPDM cables are fit for contact with drinking water, certified by WRAS (Water Regulations Advisory Scheme) in compliance with standard BS 6920.

Vérifier que le courant considéré soit effectivement celui absorbé par le moteur dans les conditions réelles de service.
 Les longueurs marquées en caractères gras se réfèrent aux câbles en EPDM/EPR seulement

Les longueurs des câbles se réfèrent à une température ambiante de 30°C; pose à l'air libre, alimentation 400V [50Hz]; cosφ = 0.8 et chute de tension admissible = 3%. En cas de conditions différentes, vérifier soigneusement les paramètres de sélection (voir "Calcul de la section" et "Courant maximum admissible")

Vérifier que la section sélectionnée pour le câble de remontée soit supérieure ou égale à la section du câble de sortie moteur.
 En cas de conditions différentes, contacter notre service commercial

* Les câbles en EPDM sont indiqués pour le contact avec l'eau potable, certifiés par le WRAS (Water Regulations Advisory Scheme) conformément à la réglementation BS 6920.

Assicurarsi che la corrente considerata sia effettivamente quella assorbita dal motore nelle condizioni reali d'esercizio.
 Le lunghezze contrassegnate in grassetto sono riferite solo ai cavi in EPDM/EPR.

Le lunghezze dei cavi sono riferite ad una temperatura ambiente di 30°C; installazione in aria; alimentazione 400V [50Hz]; cosφ = 0.8 e caduta di tensione ammissibile = 3%. Per condizioni diverse, verificare accuratamente i parametri di selezione (vedi "Calcolo della sezione" e "Corrente massima ammissibile")

Assicurarsi che la sezione selezionata per il cavo di risalita sia maggiore o uguale alla sezione del cavo d'uscita motore.
 Per condizioni diverse, interpellare la sede o la rete di vendita.

* I cavi in EPDM sono idonei al contatto con l'acqua potabile, certificati dal WRAS (Water Regulations Advisory Scheme) secondo la normativa BS 6920

Max admitted length
Longueur maxi admise
Lunghezze massime ammissibili

Max length [m] - EPDM/EPR or PVC three-pole power cables - Longueur maxi admise [m] - EPDM/EPR ou PVC three-pole power cables
Lunghezza MAX [m] - Cavo di alimentazione Tripolare EPDM/EPR o PVC

Star-delta starting - 6 cables Motor exit / Démarrage étoile-triangle - Sortie moteur 6 câbles / Avviamento stella-triangolo - Motore con uscita 6 cavi
2 Cables wit section 3 x ... / 2 Câble, section (s) 3 x ... / 2 cavi di sezione (s) 3 x ...

I [A]	S [mm ²]													
	1,5	2,5	4	6	10	16	25	35	50	70	95	120	150	185
10	93	155	248	370										
15	62	103	165	247	420									
20	47	77	124	185	315	488								
25	37	62	99	148	252	391	589							
30	31	52	83	123	210	326	491							
40		39	62	92	158	244	368	502						
50		31	50	74	126	195	295	401	554					
60			41	62	105	163	246	334	462					
70			35	53	90	140	210	287	396	534				
80				46	79	122	184	251	347	467	580			
90				41	70	109	164	223	308	415	516			
100					63	98	147	201	277	374	464	561		
120					53	81	123	167	231	311	387	468	546	
140						70	105	143	198	267	331	401	468	534
160						61	92	125	173	233	290	351	410	467
180							82	111	154	208	258	312	364	415
200							74	100	139	187	232	281	328	374
220								91	126	170	211	255	298	340
240								84	116	156	193	234	273	311
260								77	107	144	178	216	252	287
280									99	133	166	200	234	267
300									92	125	155	187	219	249
320									87	117	145	175	205	234

Make sure that the current considered is effectively that absorbed by the motor in the real operating conditions.

The lengths given in boldface type refer solely to cables in EPDM/EPR

The cable lengths refer to 30°C ambient temperature; installation in air; 400[V] 50[Hz] power supply; $\cos\phi = 0.8$ and 3% permissible voltage drop. Check the selection parameters carefully if the conditions are different (see "Calculation of cross-section" and "Maximum permitted current")

Make sure that the section of the riser cable is the same as the section of the motor output cable, or larger.

If the conditions are different, please contact our sales organization.

* The EPDM cables are fit for contact with drinking water, certified by WRAS (Water Regulations Advisory Scheme) in compliance with standard BS 6920.

Vérifier que le courant considéré soit effectivement celui absorbé par le moteur dans les conditions réelles de service.

Les longueurs marquées en caractères gras se réfèrent aux câbles en EPDM/EPR seulement.

Les longueurs des câbles se réfèrent à une température ambiante de 30°C; pose à l'air libre; alimentation 400[V] 50[Hz]; $\cos\phi = 0.8$ et chute de tension admissible = 3%. En cas de conditions différentes, vérifier soigneusement les paramètres de sélection (voir "Calcul de la section" et "Courant maximum admissible").

Vérifier que la section sélectionnée pour le câble de remontée soit supérieure ou égale à la section du câble de sortie moteur.

En cas de conditions différentes, contacter notre service commercial

* Les câbles en EPDM sont indiqués pour le contact avec l'eau potable, certifiés par le WRAS (Water Regulations Advisory Scheme) conformément à la réglementation BS 6920.

Assicurarsi che la corrente considerata sia effettivamente quella assorbita dal motore nelle condizioni reali d'esercizio.

Le lunghezze contrassegnate in grassetto sono riferite solo ai cavi in EPDM/EPR.

Le lunghezze dei cavi sono riferite ad una temperatura ambiente di 30°C; installazione in aria; alimentazione 400[V] 50[Hz]; $\cos\phi = 0.8$ e caduta di tensione ammessa = 3%. Per condizioni diverse, verificare accuratamente i parametri di selezione (vedi "Calcolo della sezione" e "Corrente massima ammissibile").

Assicurarsi che la sezione selezionata per il cavo di risalita sia maggiore o uguale alla sezione del cavo d'uscita motore.

Per condizioni diverse, interpellare la sede o la rete di vendita.

* I cavi in EPDM sono idonei al contatto con l'acqua potabile, certificati dal WRAS (Water Regulations Advisory Scheme) secondo la normativa BS 6920

Max admitted length
 Longueur maxi admise
 Lunghezze massime ammissibili

Max length [m] - EPDM/EPR or PVC Single-pole power cables - Longueur maxi admise [m] - EPDM/EPR ou PVC Unipolaires power cables -
Lunghezza MAX [m] - Cavi di alimentazione unipolari EPDM/EPR o PVC
 Star-delta starting - 6 cables Motor exit / Démarrage étoile-triangle - Sortie moteur 6 câbles / Avviamento stella-triangolo - Motore con uscita 6 cavi
 6 Cables wit section (s) 1 x ... / 6 Câble, section (s) 1 x ... / 6 cavi di sezione (s) 1 x ...

I [A]	DNpompa	S [mm ²]															
		2,5	4	6	10	16	25	35	50	70	95	120	150	185			
10	4"	153	243	359	600												
	6"	152	242	356	593												
	8"-9"-10"	152	241	356	591												
	12"	152	241	354	587												
15	4"	102	162	239	400												
	6"	101	161	237	395	697											
	8"-9"-10"	101	161	237	394	694											
	12"	101	160	236	391	688											
20	4"	76	121	179	300	455											
	6"	76	121	179	297	448											
	8"-9"-10"	76	121	178	296	446											
	12"	76	120	177	293	441											
25	4"	61	97	143	240	384	535										
	6"	61	97	142	237	358	532										
	8"-9"-10"	61	97	142	237	357	519										
	12"	61	96	142	235	353	510										
30	4"	51	81	120	200	304	446	595									
	6"	51	81	119	198	298	435	575									
	8"-9"-10"	51	80	119	197	297	432	570									
	12"	51	80	118	196	294	425	558									
40	4"	38	61	90	150	228	335	446	597								
	6"	38	60	89	148	224	328	432	571								
	8"-9"-10"	38	60	89	148	223	324	428	564								
	12"	38	60	88	147	220	319	419	549								
50	4"	31	49	72	120	182	268	357	477								
	6"	30	48	71	119	179	261	345	457	587							
	8"-9"-10"	30	48	71	118	178	259	342	451	579							
	12"	30	48	71	117	176	255	335	439	558							
60	4"	25	40	60	100	152	223	297	398	518							
	6"	25	40	59	99	149	218	288	380	489	589						
	8"-9"-10"	25	40	59	99	149	216	285	378	482	579						
	12"	25	40	59	98	147	213	279	368	465	554						
70	4"	22	35	51	86	130	191	255	341	444	541						
	6"	22	35	51	85	128	187	247	328	419	505	589					
	8"-9"-10"	22	34	51	84	127	185	244	322	413	496	578					
	12"	22	34	51	84	126	182	239	313	399	475	549					
80	4"	30	45	75	114	167	223	295	389	473	560						
	6"	30	45	74	112	163	216	285	367	442	516	587					
	8"-9"-10"	30	44	74	111	162	214	282	362	434	505	574					
	12"	30	44	73	110	160	209	274	349	416	481	542	600				
90	4"	27	40	67	101	149	198	265	345	421	497	573					
	6"	27	40	66	99	145	192	254	328	393	458	522	582				
	8"-9"-10"	27	40	66	99	144	190	251	321	386	449	510	567				
	12"	27	39	65	98	142	186	244	310	370	427	482	533				
100	4"	24	36	60	91	134	178	239	311	379	448	516	582				
	6"	24	36	59	90	131	173	228	294	353	413	470	524				
	8"-9"-10"	24	36	59	89	130	171	226	289	347	404	459	511				
	12"	24	35	59	88	128	167	219	279	333	385	434	480				
120	4"	30	50	76	112	149	199	259	316	373	430	485					
	6"	30	49	75	109	144	190	245	295	344	391	437					
	8"-9"-10"	30	49	74	108	143	188	241	289	337	382	426					
	12"	29	49	73	106	140	183	233	277	320	361	400					
140	4"	43	65	96	127	170	222	271	320	368	416						
	6"	42	64	93	123	163	210	252	295	336	374						
	8"-9"-10"	42	64	93	122	161	207	248	289	328	365						
	12"	42	63	91	120	157	199	238	275	310	343						
160	4"	37	57	84	112	149	194	237	280	322	364						
	6"	37	56	82	108	143	183	221	258	294	328						
	8"-9"-10"	37	56	81	107	141	181	217	253	287	319						
	12"	37	55	80	105	137	174	208	240	271	300						
180	4"	51	74	99	133	173	210	249	286	323							
	6"	50	73	96	127	163	196	229	261	291							
	8"-9"-10"	50	72	95	125	161	193	225	255	284							
	12"	49	71	93	122	155	185	214	241	266							
200	4"	46	67	89	119	155	189	224	258	291							
	6"	45	66	86	114	147	177	206	235	262							
	8"-9"-10"	45	65	86	113	145	174	202	229	255							
	12"	44	64	84	110	140	166	192	217	240							
220	4"	41	61	81	108	141	172	203	234	265							
	6"	41	60	78	104	133	161	188	214	238							
	8"-9"-10"	41	60	76	103	131	158	184	209	232							
	12"	40	58	76	100	127	151	175	197	218							
240	4"	56	74	99	129	158	187	215	242								
	6"	54	72	95	122	147	172	196	218								
	8"-9"-10"	54	71	94	121	145	168	191	213								
	12"	53	70	91	116	139	160	181	200								
260	4"	51	69	92	120	146	172	198	224								
	6"	50	66	88	113	136	159	181	202								
	8"-9"-10"	50	66	87	111	134	155	177	196								
	12"	49	64	84	107	128	148	167	184								
280	4"	46	64	85	111	135	160	184	208								
	6"	47	62	82	105	126	147	168	187								
	8"-9"-10"	46	61	81	103	124	144	164	182								
	12"	46	60	78	100	119	137	155	171								
300	4"	45	63	80	104	126	149	172	194								
	6"	44	62	76	98	118	138	157	175								
	8"-9"-10"	43	61	75	96	116	135	153	170								
	12"	43	60	73	93	111	128	145	160								
320	4"	58	75	97	118	140	161	182									
	6"	54	71	92	110	129	147	164									
	8"-9"-10"	53	71	90	109	128	143	160									
	12"	52	69	87	104	120	136	150									

Make sure that the current considered is effectively that absorbed by the motor in the real operating conditions.

The lengths given in boldface type refer solely to cables in EPDM/EPR

The cable lengths refer to 30°C ambient temperature; installation in air; 400[V] 50[Hz] power supply; cosφ = 0,8 and 3% permissible voltage drop. Check the selection parameters carefully if the conditions are different (see "Calculation of cross-section" and "Maximum permitted current")

Make sure that the section of the riser cable is the same as the section of the motor output cable, or larger.

If the conditions are different, please contact our sales organization.

* The EPDM cables are fit for contact with drinking water, certified by WRAS (Water Regulations Advisory Scheme) in compliance with standard BS 6920.

Vérifier que le courant considéré soit effectivement celui absorbé par le moteur dans les conditions réelles de service.

Les longueurs marquées en caractères gras se réfèrent aux câbles en EPDM/EPR seulement

Les longueurs des câbles se réfèrent à une température ambiante de 30°C ; pose à l'air libre, alimentation 400[V] 50[Hz] ; cosφ = 0,8 et chute de tension admissible = 3%. En cas de conditions différentes, vérifier soigneusement les paramètres de sélection (voir "Calcul de la section" et "Courant maximum admissible").

Vérifier que la section sélectionnée pour le câble de remontée soit supérieure ou égale à la section du câble de sortie moteur.

En cas de conditions différentes, contacter notre service commercial

* Les câbles en EPDM sont indiqués pour le contact avec l'eau potable, certifiés par le WRAS (Water Regulations Advisory Scheme) conformément à la réglementation BS 6920.

Assicurarsi che la corrente considerata sia effettivamente quella assorbita dal motore nelle condizioni reali d'esercizio.

Le lunghezze contrassegnate in grassetto sono riferite solo ai cavi in EPDM/EPR.

Le lunghezze dei cavi sono riferite ad una temperatura ambiente di 30°C; installazione in aria; alimentazione 400[V] 50[Hz]; cosφ = 0,8 e caduta di tensione ammissibile = 3%. Per condizioni diverse, verificare accuratamente i parametri di selezione (vedi "Calcolo della sezione" e "Corrente massima ammissibile").

Assicurarsi che la sezione selezionata per il cavo di risalita sia maggiore o uguale alla sezione del cavo d'uscita motore.

Per condizioni diverse, interpellare la sede o la rete di vendita.

* I cavi in EPDM sono idonei al contatto con l'acqua potabile, certificati dal WRAS (Water Regulations Advisory Scheme) secondo la normativa BS 6920

Generator power
Puissance du générateur
Potenza del generatore

When an electric generator has to be used to supply the motor, it should be carefully selected. A chart is provided giving the minimum rating in kW and kVA of the generators used to supply the motors.

Dans le cas d'utilisation d'un générateur électrique pour alimenter le moteur, le choix doit être avisé. Nous fournissons un tableau indicatif des puissances minimum en kW et en kVA des générateurs pour l'alimentation des moteurs électriques

Quando si deve utilizzare un generatore elettrico per l'alimentazione del motore, è necessaria un'oculata scelta. Forniamo una tabella indicativa delle potenze minime in kW ed in kVA dei generatori per l'alimentazione dei motori elettrici.

Electric motor power Puissance moteur électrique Potenza motore elettrico		Generator power Puissance du générateur Potenza del generatore	
		Direct starting Démarrage direct Avviamento diretto	
[kW]	[HP]	[kW]	[kVA]
2.2	3	6	7.5
3	4	8	10
4	5.5	10	12.5
5.5	7.5	12.5	15.6
7.5	10	15	18.8
9.2	12.5	18.8	23.5
11	15	22.5	28
13	17.5	26.4	33
15	20	30	38
18.5	25	40	50
22	30	45	57
26	35	52	65
30	40	60	75
37	50	75	94
45	60	90	112
51	70	105	131
59	80	120	150
66	90	135	170
75	100	150	190
92	125	185	230
110	150	210	260

Electric motor power Puissance moteur électrique Potenza motore elettrico		Generator power Puissance du générateur Potenza del generatore	
		Star-delta starting Démarrage étoile-triangle Avviamento stella-triangolo	
[kW]	[HP]	[kW]	[kVA]
-	-	-	-
3	4	6	7.5
4	5.5	8	10
5.5	7.5	10.8	13.5
7.5	10	14	17.5
9.2	12.5	17.2	21.5
11	15	20.5	25.5
13	17.5	23.6	29.5
15	20	27	34
18.5	25	33	42
22	30	40	50
26	35	45	57
30	40	52	65
37	50	65	81
45	60	77	97
51	70	90	112
59	80	102	128
66	90	115	144
75	100	128	160
92	125	158	198
110	150	190	237

Common electric formulae
Formules d'usage commun
Formule di uso comune

VALUES VALEURS GRANDEZZA		ALTERNATING CURRENT COURANT ALTERNATIF CORRENTE ALTERNATA	
		SINGLE-PHASE MONOPHASE MONOFASE	THREE-PHASE TRIPHASE TRIFASE
Absorbed power (active) <i>Puissance absorbée (active)</i> Potenza assorbita (attiva)	[kW]	$P_a = \frac{U \cdot I \cdot \cos \varphi}{1000}$	$P_a = \frac{1,73 \cdot U \cdot I \cdot \cos \varphi}{1000}$
Yield power <i>Puissance utile</i> Potenza resa	[kW]	$P_r = \frac{U \cdot I \cdot \cos \varphi \cdot \eta_M}{1000}$	$P_r = \frac{1,73 \cdot U \cdot I \cdot \cos \varphi \cdot \eta_M}{1000}$
Absorbed current <i>Courant absorbé</i> Corrente assorbita	[A]	$I = \frac{P_r \cdot 1000}{U \cdot \cos \varphi \cdot \eta_M}$	$I = \frac{P_r \cdot 1000}{1,73 \cdot U \cdot \cos \varphi \cdot \eta_M}$
Power factor (cos φ) <i>Facteurs de puissance (cos φ)</i> Fattore di potenza (cos φ)	[0,.....]	$\cos \varphi = \frac{P_a \cdot 1000}{U \cdot I}$	$\cos \varphi = \frac{P_a \cdot 1000}{1,73 \cdot U \cdot I}$
Nominal torque <i>Couple nominal</i> Coppia nominale	[Nm]	$M_N = \frac{P_r \cdot 1000}{0,105 \cdot n}$	
Motor efficiency <i>Rendement du moteur</i> Rendimento motore	[%]	$\eta_M = \frac{P_r}{P_a} \cdot 100$	
Synchronous speed <i>Vitesse de synchronisme</i> Velocità sincrona	[n ⁻¹]	$n_s = \frac{f \cdot 120}{\text{No. Poli / Poles / Pôles}}$	
Sliding <i>Glissement</i> Scorrimento	[%]	$S = \frac{n_s - n}{n_s} \cdot 100$	

Electrical tolerances
Tolérances électriques
Tolleranze elettriche

Tolerances on the guaranteed values of the electrical characteristics of asynchronous motors as per CEI norms in accordance with IEC norms.

Tolérances sur les valeurs garanties des caractéristiques électriques des moteurs asynchrones selon les Normes CEI en accord avec les Normes IEC.

Tolleranze sui valori garantiti delle caratteristiche elettriche dei motori asincroni, secondo Norme CEI in accordo con le Norme IEC.

VALUE VALEURS GRANDEZZA		TOLERANCE TOLERANCE TOLLERANZA
Real efficiency <i>Rendement réel</i> Rendimento effettivo	[η]	$-0,15 \cdot (1 - \eta_G) [\%]$
Power factor <i>Facteur de puissance</i> Fattore di potenza	[cos φ]	$-\frac{1}{6} \cdot (1 - \cos \varphi) \left[\begin{array}{l} \text{min: } 0,02 \\ \text{max: } 0,07 \end{array} \right]$
Sliding <i>Glissement</i> Scorrimento	[S]	± 20%

VALUE VALEURS GRANDEZZA		TOLERANCE TOLERANCE TOLLERANZA
Maximum torque <i>Couple maximal</i> Coppia massima	[M _M]	- 10% (min 1,6 M _N) [Nm]
Starting torque <i>Couple de démarrage</i> Coppia di spunto	[M _s]	+ 25% - 15%
Starting current <i>Intensité de démarrage</i> Corrente di spunto	[I _s]	+ 20% [A]

Reactive power compensation
Compensation de la puissance réactive
Compensazione della potenza reattiva

Asynchronous motors absorb, from the main, "apparent" electrical power which is partly "active" power, and partly "reactive" power; the latter is used for motor magnetization and cannot be technically eliminated.

The ratio of "active power" to "apparent power" forms the "power factor" or $\cos \varphi$.

The absorbed reactive power on the line can be reduced, according with the current rules, modifying the phase displacement between absorbed current and supply tension.

Everything must be realised using an appropriate power capacitors battery.

Les moteurs asynchrones absorbent sur le réseau une puissance électrique "apparente" constituée en partie d'une puissance "active" et en partie d'une puissance "réactive".

Cette dernière sert à la magnétisation du moteur et ne peut pas être techniquement supprimée.

Le rapport entre "puissance active" et "puissance apparente" constitue le "facteur de puissance" ou $\cos \varphi$.

La puissance réactive absorbée sur la ligne peut être réduite, selon les normes en vigueur, en modifiant le déphasage entre courant absorbé et tension d'alimentation.

Ceci devra être réalisé en utilisant une adéquate batterie des condensateurs de puissance.

I motori asincroni assorbono dalla rete potenza elettrica "apparente" costituita in parte da potenza "attiva" ed in parte da potenza "reattiva"; quest'ultima serve alla magnetizzazione del motore e non può essere tecnicamente soppressa.

Il rapporto fra "potenza attiva" e "potenza apparente" costituisce il "fattore di potenza", o $\cos \varphi$.

La potenza reattiva assorbita sulla linea può essere ridotta, in base alle norme vigenti, modificando lo sfasamento tra corrente assorbita e la tensione di alimentazione. Ciò dovrà essere realizzato utilizzando opportuna batteria di condensatori di potenza.

Nomogram for determining P_c power [kVAR] of phase-shift capacitors
Nomogramme pour la détermination de la puissance P_c [kVAR] des condensateurs de rattrapage.
Nomogramma per la determinazione della potenza P_c [kVAR] dei condensatori di rifasamento.

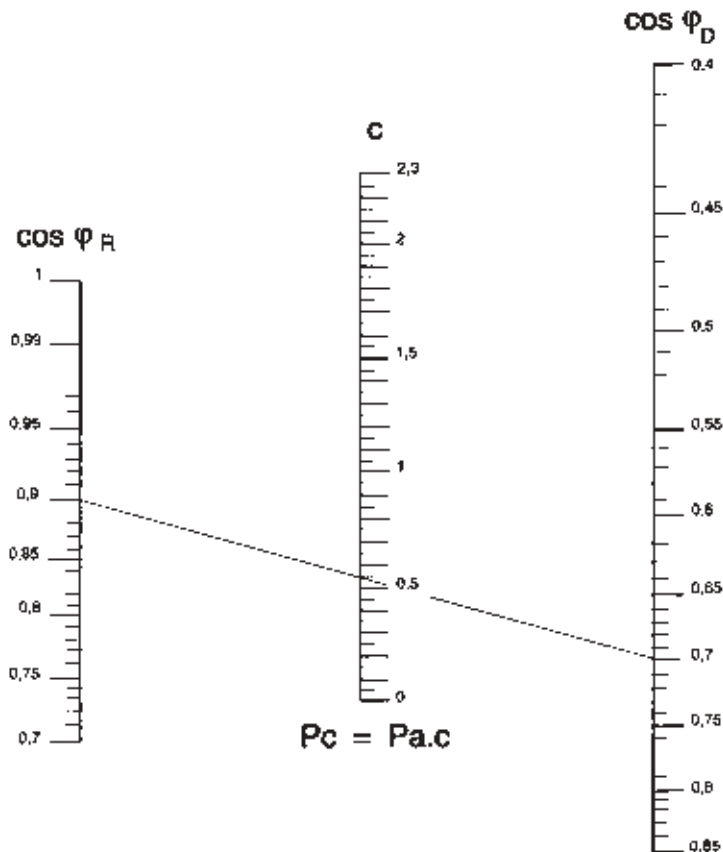

Example:
Electrical input (active) P_a motor = 20 kW
Available power factor $\cos \varphi_D = 0,7$
Required power factor $\cos \varphi_R = 0,9$
Multiplying factor (from nomogram) $c = 0,54$
Phase-shift capacitor power P_c
 $P_c = P_a \times c = 20 \times 0,54 = 10,8$ kVAR

Exemples:
Puissance absorbée (active) du moteur $P_a = 20$ kW
Factor de puissance disponible $\cos \varphi_D = 0,7$
Factor de puissance recherchée $\cos \varphi_R = 0,9$
Facteur multiplicatif (du nomogramme) $c = 0,54$
Puissance des condensateurs P_c
 $P_c = P_a \times c = 20 \times 0,54 = 10,8$ kVAR

Esempio:
Potenza attiva motore $P_a = 20$ kW
Fattore di potenza disponibile $\cos \varphi_D = 0,7$
Fattore di potenza richiesto $\cos \varphi_R = 0,9$
Fattore moltiplicativo da nomogramma $c = 0,54$
Potenza del condensatore di rifasamento P_c
 $P_c = P_a \times c = 20 \times 0,54 = 10,8$ kVAR

DCL Low level safety device
DCL Dispositif pour défaut d'eau et contrôle niveau
DCL Dispositivo contro la marcia a secco e controllo del livello

The conductivity electronic device DCL, is used for monitoring the levels of conductive liquids in wells, tanks or reservoirs.

In the case of minimum and maximum level control (prevention of dry running and automatic reset of the electric pump), the relay is at rest until the liquid reaches the upper level.

At this point the relay starts working thereby exciting the remote control switch coil (causing the electric pump to start and keeps this state until the liquid drows down below the minimum level.

During minimum level checking (prevention of dry running) relay remains constantly excited if pumped liquids is available.

Relay is not excited when there is no liquid or voltage lacks.

If so, relay must be manually reset.

Le dispositif électroniques à conductivité DCL, sert à relever ou à contrôler les niveau du liquide conducteur dans les puits, les baches ou les réservoirs.

En cas de contrôle du niveau minimum ou maximum (protection contre la marche à sec et remise en marche automatique de l'électropompe), le relais se maintient en situation de repos tant que le liquide n'a pas atteint le niveau supérieur.

A ce point, le relais excite la bobine du télérupteur (qui provoque le démarrage de l'électropompe) et la maintient jusqu'à ce que le liquide descend sous le niveau minimum.

Quand on va vérifier le niveau minimum (protection contre la marche à sec) le relais reste toujours excité en presence du liquide pompé. Il n'est pas excité en absence du liquide ou quand la tension manque. Dans cette occasion le relais doit être réarmé manuellement.

I dispositivo elettronico a conduttività DCL, serve a rilevare o controllare i livelli dei liquidi conduttivi in pozzi, vasche o serbatoi.

Nel caso di controllo di minimo e massimo livello (protezione contro la marcia a secco e riavviamento automatico della elettropompa), il relè si mantiene in stato di riposo fintanto che il liquido non ha raggiunto il livello superiore.

A questo punto, il relè entra in conduzione eccitando la bobina del teleruttore (che provoca, tramite l'apparecchiatura elettrica, l'avviamento dell'elettropompa) e mantiene tale stato finchè il liquido non scende sotto in livello minimo.

Nel caso di semplice controllo di minimo livello (protezione contro la marcia a secco), il relè rimane costantemente eccitato in presenza del liquido diseccitandosi in assenza di questo o per mancanza di tensione e deve essere riarmato manualmente.

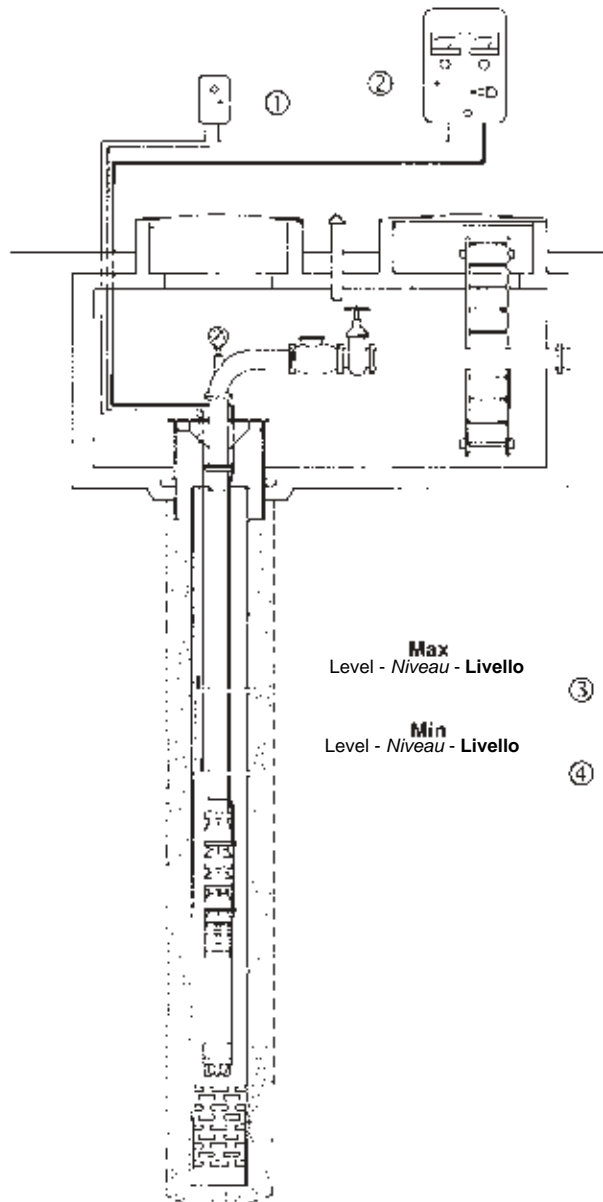

- 1) Low level safety device
- 2) Electric equipment
- 3) Maximum level electric probe
- 4) Minimum level electric probe

- 1) Dispositif complet pour défaut d'eau
- 2) Appareillage électrique
- 3) Sondes électriques au max. de niveau
- 4) Sondes électriques au min. de niveau

- 1) Dispositivo contro la marcia a secco
- 2) Apparecchiatura elettrica
- 3) Sonda elettrica max. livello
- 4) Sonda elettrica min. livello

T-412 Temperature monitoring device for submersed electric motors
 T-412 Appareillage de contrôle de la température des moteurs électriques immergés
 T-412 Apparechiatura di controllo temperatura motori elettrici sommersi

T412 monitors the temperature inside the electric motor.

Connected to the PT100 probe (housed in the electric motor), it is able to read operating temperatures from 0-200°C.
 T412 is supplied without a setting.

How to make the setting:

- Start the electric pump and set it to the operating point with the highest power input. The internal temperature will rise progressively and will be monitored by the probe. When it has reached full rate (this may take up to 2 hours, depending on the motor), the temperature reading will stabilize.
- Once the temperature has become stable, select a value equal to the temperature reading +3°C for the first alarm setting. The alarm must record the excess temperature so as to produce documentation upon the first inspection;
- The setting for the second alarm, which must stop the motor, must equal the temperature reading +6°C; the excess temperature recording can be automatic, but must occur with a delay of at least 15 minutes from the stopping action or when the internal temperature of the motor is 20°C less than the alarm temperature setting;
ACTIVATION OF THE 2nd ALARM, WHICH STOPS THE MOTOR, WILL OCCUR WHEN:
 - There is an overload
 - There is a poor cooling action
 - There are too frequent starts

With the motor rotor wound in:

- In PVC, the maximum temperature setting of the second alarm must be 58°C
- In PE2+PA, the maximum temperature setting of the second alarm must be 75°C.
 This device can also be used for monitoring the temperature of bearings, lubricants, in surface electric motors and machinery in general.
 The device complies with electromagnetic compatibility standards CEI EN-50081-2 and 50082-2.
 Dimensions: 48*96 mm DIN 43700
 depth:130 mm.

L'appareillage T412 sert à contrôler la température interne du moteur électrique.

Branché à la sonde PT100 (logée à l'intérieur du moteur électrique) il permet la lecture de la température de fonctionnement entre 0-200°C.
 L'appareillage T412 est fourni sans réglage.

Mode de réglage :

- Mettre l'électropompe en marche et se placer dans le point de travail où la puissance absorbée est la plus élevée, la température interne augmentera progressivement et sera relevée par la sonde. Au régime établi (deux heures peuvent s'écouler, suivant le type de moteur) la température lue se stabilisera.
- Quand la température est stable, régler la première alarme à une valeur égale à la température lue +3°C, l'alarme doit enregistrer le dépassement pour en faire l'acquisition au premier contrôle;
- La deuxième alarme, qui doit commander l'arrêt du moteur, devra être étalonnée à une valeur égale à la température lue +6°C; le redémarrage, avec enregistrement du dépassement, peut être automatique mais doit avoir lieu avec un retard, par rapport à l'arrêt, d'au moins 15 minutes ou à une température interne du moteur inférieure de 20°C par rapport à la température de réglage de l'alarme.
L'INTERVENTION DE LA 2e ALARME, AVEC ARRÊT DU MOTEUR, SE PRODUIT:
 - En cas de surcharge ;
 - En cas de refroidissement insuffisant;
 - En cas de démarrages trop fréquents.

Avec moteur à rotor bobiné:

- In PVC, la température maximum de réglage de la deuxième alarme est de 58°C.
- In PE2+PA, la température maximum de réglage de la deuxième alarme est de 75°C.
 Ce dispositif pourra aussi être utilisé pour contrôler les températures des roulements, des lubrifiants, dans les moteurs électriques de surface et dans les machines en général.
 L'appareillage est conforme aux normes de compatibilité électromagnétique CEI EN-50081-2 et 50082-2.
 Dimensions: 48*96 mm DIN 43700
 profondeur: 130 mm.

L'apparechiatura T412, serve a monitorare la temperatura interna del motore elettrico.

Collegata alla sonda PT100 (alloggiata all'interno del motore elettrico) permette la lettura della temperatura di funzionamento tra 0-200°C .
 L'apparechiatura T412 viene fornita senza il settaggio.

Modalità per il settaggio:

- Avviare l'elettropompa e posizionarsi nel punto di lavoro a maggiore potenza assorbita, la temperatura nel suo interno crescerà progressivamente e verrà monitorata dalla sonda. A regime (a seconda del motore possono trascorrere fino a 2 ore) la temperatura letta si stabilizzerà.
- A lettura stabile della temperatura tarare il primo allarme ad un valore pari alla temperatura letta +3°C, l'allarme deve registrare il superamento per averne documentazione alla prima ispezione;
- Il secondo allarme, che deve comandare l'arresto del motore, dovrà essere tarato ad un valore pari alla temperatura letta +6°C; il riavviamento, con registrazione del superamento, può essere automatico ma deve avvenire con un ritardo dall'arresto di almeno 15 minuti o a una temperatura interna del motore inferiore di 20°C rispetto alla temperatura settata di allarme;
L'INTERVENTO DEL 2° ALLARME, CON ARRESTO DEL MOTORE, AVVIENE QUANDO :
 - C'è un sovraccarico
 - C'è uno scarso raffreddamento
 - Ci sono frequenti avviamenti

Con il motore avvolto :

- In PVC la massima temperatura di settaggio del secondo allarme potrà essere di 58°C
- In PE2+PA la massima temperatura di settaggio del secondo allarme potrà essere di 75°C.
 Tale dispositivo potrà essere utilizzato anche per monitorare le temperature dei cuscinetti, dei lubrificanti, nei motori elettrici di superficie e nelle macchine operatrici in generale.
 L'apparechiatura rispetta le norme di compatibilità elettromagnetica CEI EN-50081-2 e 50082-2.
 Dimensioni : 48*96 mm DIN 43700
 profondità: 130 mm.

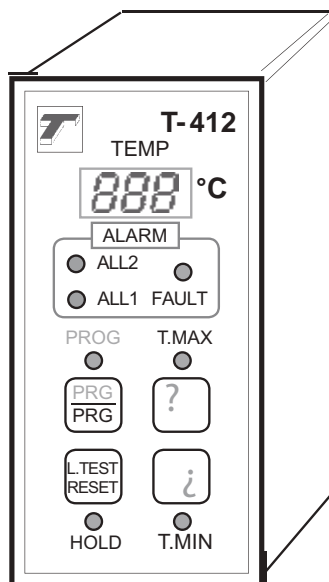

T-412

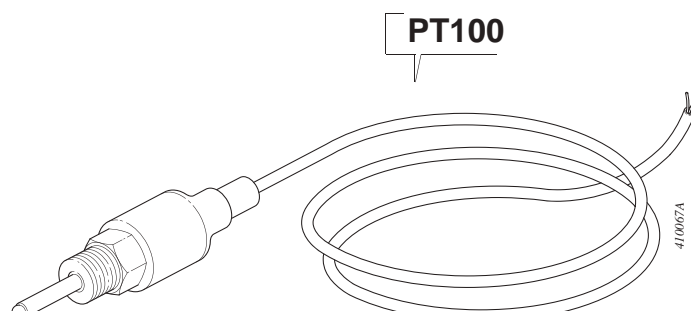

MEI = 0.4 for Multistage Submersible 2900rpm

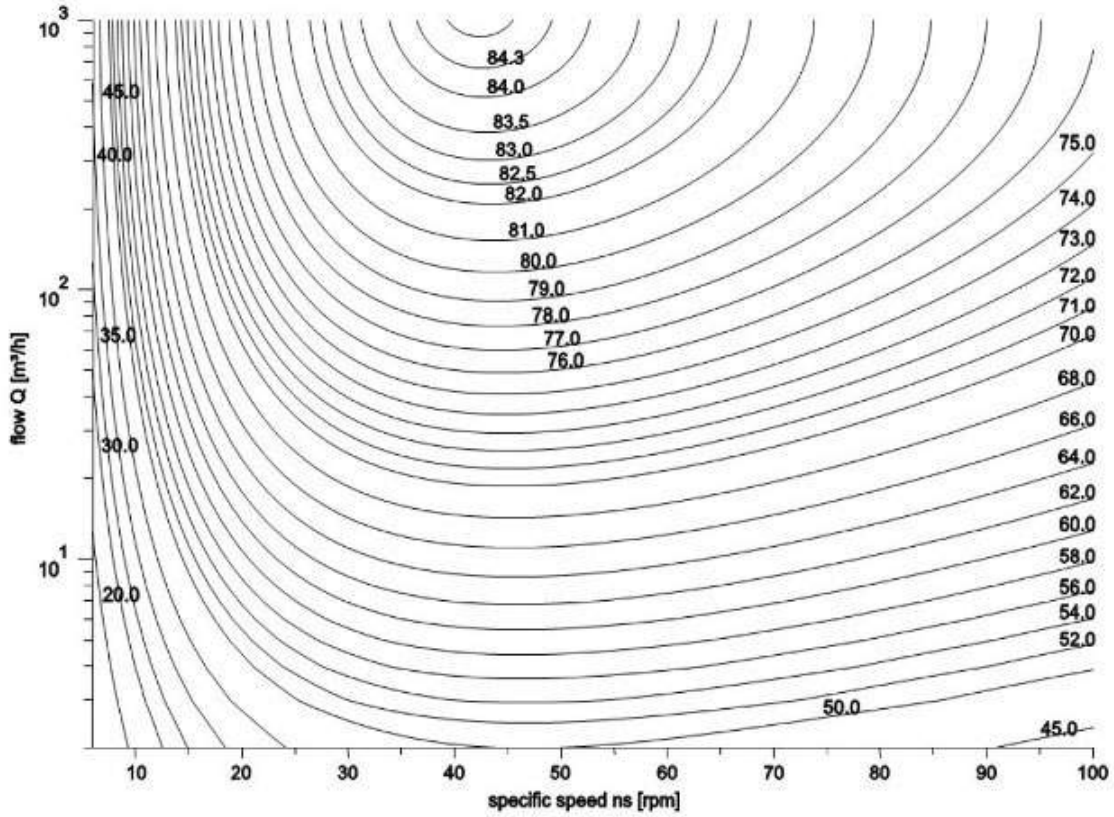

MEI = 0.7 for Multistage Submersible 2900 rpm

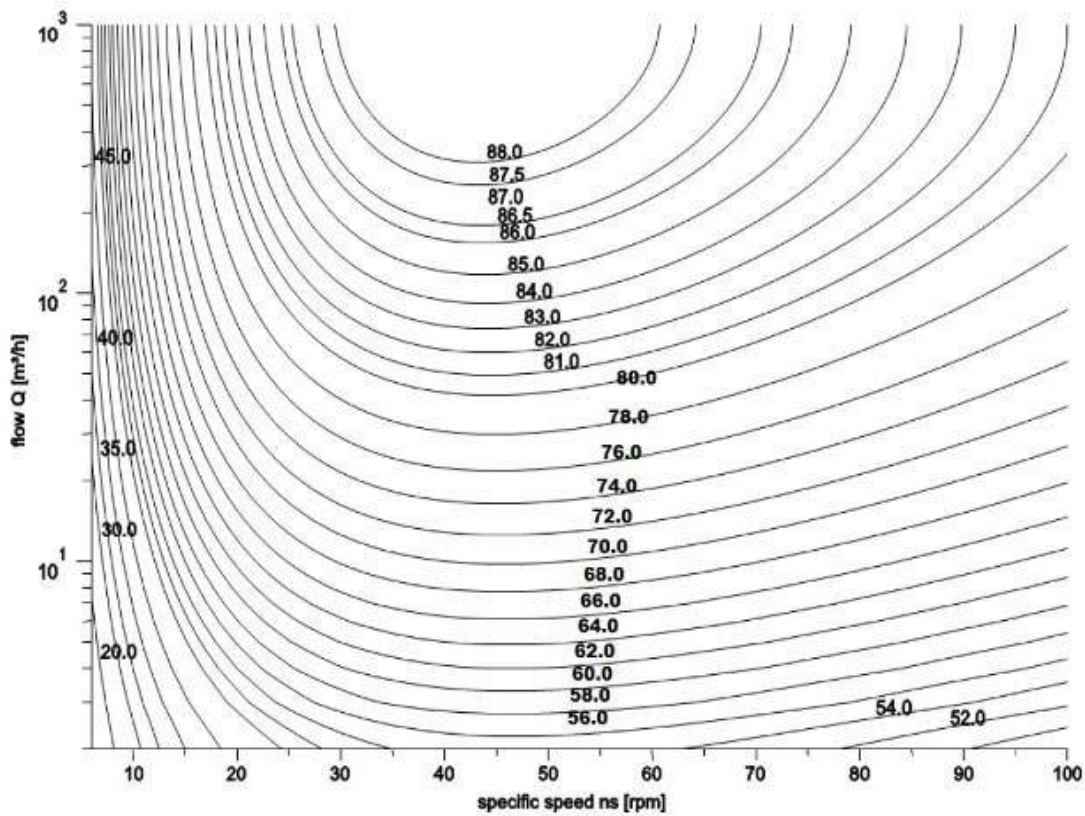

caprari

The dimensions have an indicative value. Executive drawing will be supplied on request upon order.
CAPRARI S.p.A. reserves the right to make changes to improve its products at any time and without any notice

*Les dimensions sont fournies à titre indicatif. Le plan bon pour exécution sera fourni sur demande au moment de la commande.
CAPRARI S.p.A. se réserve la faculté d'apporter des modifications visant à améliorer ses propres produits à tout moment et sans aucun préavis.*

**Le dimensioni hanno valore indicativo. Il disegno esecutivo sarà fornito su richiesta in fase d'ordine.
CAPRARI S.p.A. si riserva facoltà di apportare modifiche atte a migliorare i propri prodotti in qualsiasi momento e senza preavviso alcuno.**