

Type Type Tipo	Inlet maximum pressure (*) Pression maximale en aspiration (*) Pressione massima in aspirazione (*)	Dinamic momentum J Momentum dynamique J Momento dinamico J	
		With cast iron impellers Avec roues en fonte Con giranti in ghisa	With AISI 316 impellers Avec roues en AISI 316 Con giranti in AISI 316
		J = 1/4 PD <sup>2</sup>	
	[bar]	[kgm <sup>2</sup> ]	[kgm <sup>2</sup> ]
NC40-250	6	0,0411814	(F) 0,0470645

Construction reference standard EN733 (DIN24255)  
 (\*) Value referred to the impeller with maximum diameter.

Norme de référence construction EN733 (DIN24255)  
 (\*) Valeur se référant à la roue à ailettes avec le diamètre maximum.

Norma di riferimento costruttivo EN733 (DIN24255)  
 (\*) Valore riferito alla girante con diametro massimo.

Overall dimensions and weights  
 Dimensions d'encombrement et poids  
 Dimensioni di ingombro e pesi

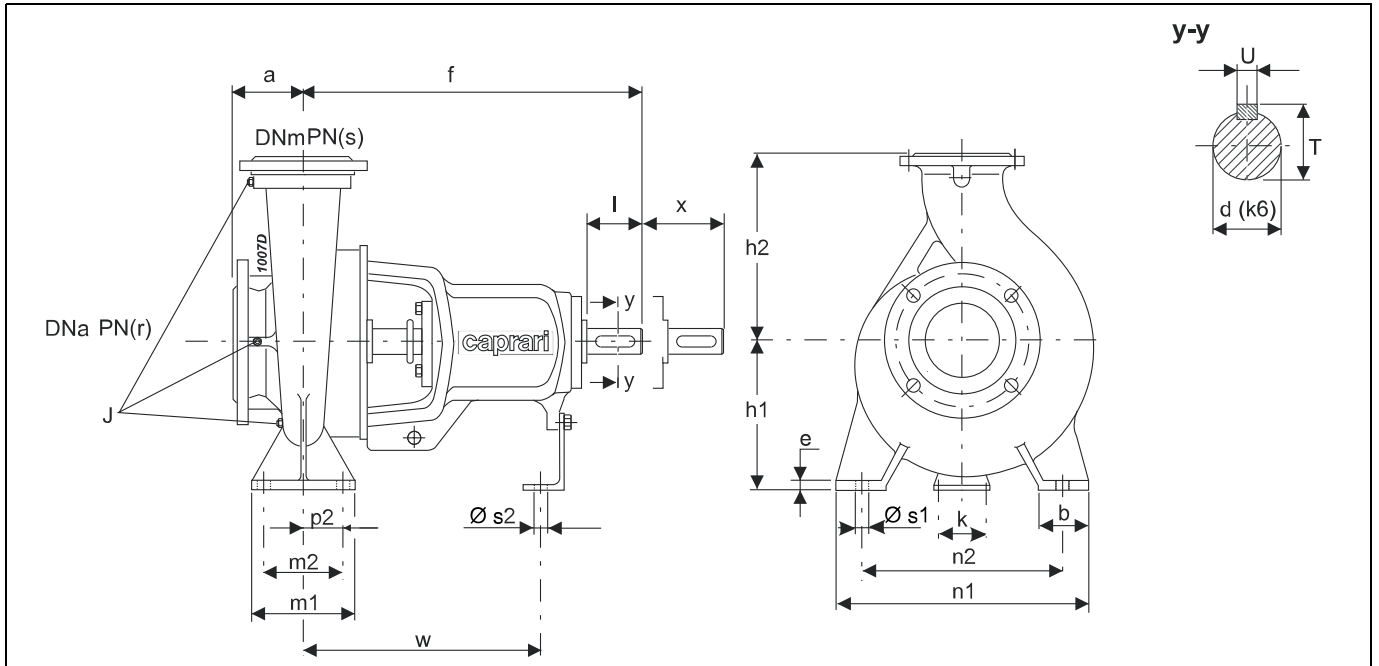

Type Type Tipo	Dimensions pump Dimensions pompe Dimensioni pompa						Duck foot pedestal dimensions Dimensions pieds de soutien Dimensioni piedi di appoggio								Shaft projection Saillie d'arbre Sporgenza d'albero					Plugs Bouchons Tappi	Weight Poids Peso					
	DNa	DNm	r	s	a	f	h1	h2	b	e	m1	m2	p2	n1	n2	k	w	s1	s2	d	l	T	U	X	J	[kg]
NC32-125	50	32	16	16	80	360	112	140	50	14	100	70	-	190	140	100	260	Ø 14	Ø 14	24	50	27	8	100	G1/4x2.G3/8.G1/4	28
NC32-160	50	32	16	16	80	360	132	160	50	14	100	70	-	240	190	100	260	Ø 14	Ø 14	24	50	27	8	100	G1/4x2.G3/8.G1/4	35
NC32-200	50	32	16	16	80	360	160	180	50	14	100	70	-	240	190	110	260	Ø 14	Ø 14	24	50	27	8	100	G1/4.G3/8x2.G1/4	41
NC32-250	50	32	16	16	100	360	180	225	65	14	125	95	-	320	250	110	260	Ø 14	Ø 14	24	50	27	8	100	G1/4.G3/8x2.G1/4	59
NC40-125	65	40	16	16	80	360	112	140	50	14	100	70	-	210	160	100	260	Ø 14	Ø 14	24	50	27	8	100	G1/4x2.G3/8.G1/4	30
NC40-160	65	40	16	16	80	360	132	160	50	14	100	70	-	240	190	100	260	Ø 14	Ø 14	24	50	27	8	100	G1/4x2.G3/8.G1/4	36
NC40-200	65	40	16	16	100	360	160	180	50	14	100	70	-	265	212	110	260	Ø 14	Ø 14	24	50	27	8	100	G1/4.G3/8x2.G1/4	44
NC40-250	65	40	16	16	100	360	180	225	65	14	125	95	-	320	250	110	260	Ø 14	Ø 14	24	50	27	8	100	G1/4.G3/8x2.G1/4	61
NC40-315	65	40	16	16	125	470	200	225	65	14	125	95	-	345	280	110	340	Ø 14	Ø 14	32	80	35	10	100	G1/4.G3/8x2.G1/4	96
NC50-125	65	50	16	16	100	360	132	160	50	14	100	70	-	240	190	100	260	Ø 14	Ø 14	24	50	27	8	100	G1/4x2.G3/8.G1/4	34
NC50-160	65	50	16	16	100	360	160	180	50	14	100	70	-	265	212	110	260	Ø 14	Ø 14	24	50	27	8	100	G1/4.G3/8x2.G1/4	38
NC50-200	65	50	16	16	100	360	160	200	50	14	100	70	-	265	212	110	260	Ø 14	Ø 14	24	50	27	8	100	G1/4.G3/8x2.G1/4	46
NC50-250	65	50	16	16	100	360	180	225	65	14	125	95	-	320	250	110	260	Ø 14	Ø 14	24	50	27	8	100	G1/4.G3/8x2.G1/4	71
NC50-315	65	50	16	16	125	470	225	280	65	16	125	95	-	345	280	110	340	Ø 14	Ø 14	32	80	35	10	100	G1/4.G3/8x2.G1/4	101
NCH50-315	80	50	16	25	125	500	225	280	65	18	125	95	-	345	280	110	370	Ø 14	Ø 14	32	80	35	10	100	G1/4x3	87
NC65-125	80	65	16	16	100	360	160	180	65	14	125	95	-	280	212	110	260	Ø 14	Ø 14	24	50	27	8	100	G1/4x2.G3/8.G1/4	39
NC65-160	80	65	16	16	100	360	160	200	65	14	125	95	-	280	212	110	260	Ø 14	Ø 14	24	50	27	8	100	G1/4.G3/8x2.G1/4	43
NC65-200	80	65	16	16	100	360	180	225	65	14	125	95	-	320	250	110	260	Ø 14	Ø 14	24	50	27	8	100	G1/4.G3/8x2.G1/4	52
NC65-250	80	65	16	16	100	470	200	250	80	16	160	120	-	360	280	110	340	Ø 18	Ø 14	32	80	35	10	100	G1/4.G3/8x2.G1/4	81
NC65-315	80	65	16	16	125	470	225	280	80	16	160	120	-	400	315	110	340	Ø 18	Ø 14	32	80	35	10	100	G1/4.G3/8x2.G1/4	110
NCH65-315	100	65	16	16	125	530	225	280	80	18	160	120	-	400	315	110	370	Ø 18	Ø 14	42	110	45	12	140	G1/4x3	118
NC80-160	100	80	16	16	125	360	180	225	65	14	125	95	-	320	250	110	260	Ø 14	Ø 14	24	50	27	8	100	G1/4.G3/8x2.G1/4	54
NC80-200	100	80	16	16	125	470	180	250	65	14	125	95	-	345	280	110	340	Ø 14	Ø 14	32	80	35	10	100	G1/4.G3/8x2.G1/4	75
NC80-250	100	80	16	16	125	470	200	280	80	16	160	120	-	400	315	110	340	Ø 18	Ø 14	32	80	35	10	100	G1/4.G3/8x2.G1/4	91
NC80-315	100	80	16	16	125	470	250	315	80	16	160	120	-	400	315	110	340	Ø 18	Ø 14	32	80	35	10	100	G3/8x3. G3/8	120
NC80-400	100	80	16	16	125	532	280	355	85	16	160	120	-	440	340	110	370	Ø 18	Ø 14	42	110	45	12	140	G3/8x2 G1/2. G1/4	161
NC100-160	125	100	16	16	125	470	200	250	80	16	160	120	-	360	280	110	340	Ø 18	Ø 14	32	80	35	10	140	G3/8x3. G1/4	71

Selection - dimensions and weights for base mounted electric pumps  
 Sélection - dimensions et poids des électropompes sur socle  
 Selezione - dimensioni e pesi elettropompe su base

COUPLINGS WITH STANDARDIZED ENCLOSED ELECTRIC MOTORS  
 ACCOUPLEMENTS AVEC MOTEURS ÉLECTRIQUES FERMÉS NORMALISÉS  
 ACCOPIAMENTI CON MOTORI ELETTRICI CHIUSI NORMALIZZATI

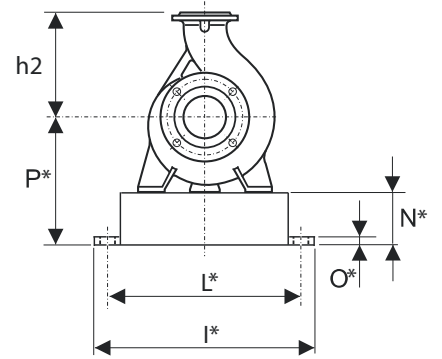
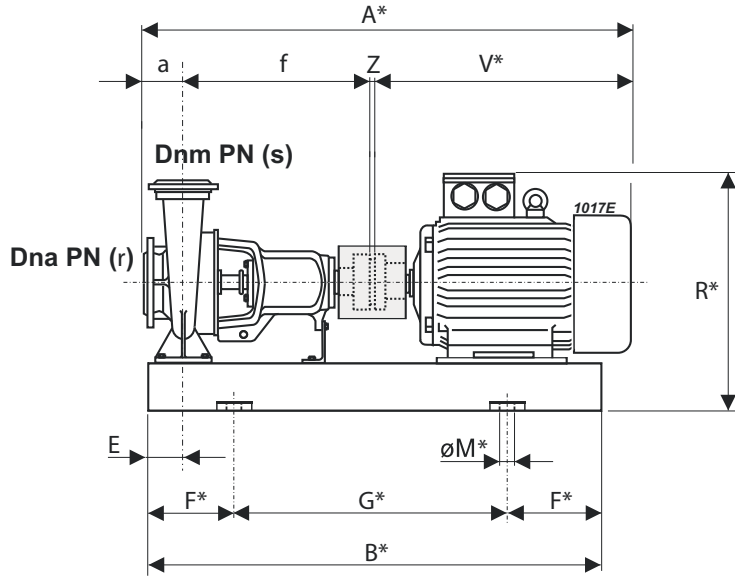

Pump Pompe Pompa		Motor Moteur Motore		BGAN	A*	B*	E	F*	G*	I*	L*	M*	N*	O*	P*	R*	V*	Z	a	f	h2	r	s	Weight Poids Peso	
Type Type Tipo	DNa [mm]	DNm [mm]	[kW]	Size Taille Grand.	Type Type Tipo	[mm]																			[kg]
NC32-125	50	32	1,1	80M	1001/CA	739	649	60	100	449	320	270	ø 16	50	38	162	287	295	4	80	360	140	16	16	54
NC32-125	50	32	1,5	90S	1002/CA	799	665	60	100	465	320	270	ø 16	50	38	162	300	355	4	80	360	140	16	16	58
NC32-125	50	32	2,2	90L	1003/CA	829	690	60	100	490	320	270	ø 16	50	38	162	300	385	4	80	360	140	16	16	61
NC32-160	50	32	2,2	90L	1004/CA	829	690	60	100	490	370	320	ø 16	65	38	197	335	385	4	80	360	160	16	16	74
NC32-160	50	32	3	100L	1005/CA	849	724,5	60	100	524,5	370	320	ø 16	65	38	197	347	405	4	80	360	160	16	16	81
NC32-160	50	32	4	112M	1006/CA	884	732	60	100	532	370	320	ø 16	65	38	197	369	440	4	80	360	160	16	16	88
NC32-160	50	32	5,5	132S	1007/CA	899	773	60	150	473	405	355	ø 16	65	38	197	389	455	4	80	360	160	16	16	98
NC32-160	50	32	7,5	132S	1007/CA	899	773	60	150	473	405	355	ø 16	65	38	197	389	455	4	80	360	160	16	16	103
NC32-200	50	32	5,5	132S	1008/CA	899	773	60	150	473	405	355	ø 16	80	38	240	432	455	4	80	360	180	16	16	108
NC32-200	50	32	7,5	132S	1008/CA	899	773	60	150	473	405	355	ø 16	80	38	240	432	455	4	80	360	180	16	16	113
NC32-200	50	32	11	160M	1009/DA	1071	897	60	150	597	465	415	ø 16	80	38	240	491	627	4	80	360	180	16	16	195
NC32-250	50	32	11	160M	1014/DA	1091	909,5	72,5	150	609,5	450	400	ø 20	100	42	280	531	627	4	100	360	225	16	16	239
NC32-250	50	32	15	160M	1014/DA	1091	909,5	72,5	150	609,5	450	400	ø 20	100	42	280	531	627	4	100	360	225	16	16	250
NC32-250	50	32	18,5	160L	1015/DA	1091	953,5	72,5	150	653,5	450	400	ø 20	100	42	280	531	627	4	100	360	225	16	16	252
NC40-125	65	40	1,5	90S	1010/CA	799	665	60	100	465	340	290	ø 16	50	38	162	300	355	4	80	360	140	16	16	60
NC40-125	65	40	2,2	90L	1011/CA	829	690	60	100	490	340	290	ø 16	50	38	162	300	385	4	80	360	140	16	16	64
NC40-125	65	40	3	100L	1150/CA	849	724,5	60	100	524,5	340	290	ø 16	50	38	162	312	405	4	80	360	140	16	16	71
NC40-160	65	40	3	100L	1005/CA	849	724,5	60	100	524,5	370	320	ø 16	65	38	197	347	405	4	80	360	160	16	16	82
NC40-160	65	40	4	112M	1006/CA	884	732	60	100	532	370	320	ø 16	65	38	197	369	440	4	80	360	160	16	16	89
NC40-160	65	40	5,5	132S	1007/CA	899	773	60	150	473	405	355	ø 16	65	38	197	389	455	4	80	360	160	16	16	99
NC40-160	65	40	7,5	132S	1007/CA	899	773	60	150	473	405	355	ø 16	65	38	197	389	455	4	80	360	160	16	16	104
NC40-200	65	40	5,5	132S	1012/CA	919	773	60	150	473	395	345	ø 16	80	38	240	432	455	4	100	360	180	16	16	120
NC40-200	65	40	7,5	132S	1012/CA	919	773	60	150	473	395	345	ø 16	80	38	240	432	455	4	100	360	180	16	16	125
NC40-200	65	40	11	160M	1013/DA	1091	897	60	150	597	465	415	ø 16	80	38	240	491	627	4	100	360	180	16	16	209
NC40-200	65	40	15	160M	1013/DA	1091	897	60	150	597	465	415	ø 16	80	38	240	491	627	4	100	360	180	16	16	220
NC40-250	65	40	11	160M	1014/DA	1091	909,5	72,5	150	609,5	450	400	ø 20	100	42	280	531	627	4	100	360	225	16	16	241
NC40-250	65	40	15	160M	1014/DA	1091	909,5	72,5	150	609,5	450	400	ø 20	100	42	280	531	627	4	100	360	225	16	16	252
NC40-250	65	40	18,5	160L	1015/DA	1091	953,5	72,5	150	653,5	450	400	ø 20	100	42	280	531	627	4	100	360	225	16	16	254
NC40-250	65	40	22	180M	1016/EA	1129	963,5	72,5	150	663,5	500	450	ø 20	100	42	280	550	665	4	100	360	225	16	16	305
NC40-250	65	40	30	200L	1017/FA	1202	1061,5	97,5	200	661,5	540	490	ø 20	100	42	300	600	738	4	100	360	225	16	16	356
NC40-250	65	40	37	200L	1017/FA	1202	1061,5	97,5	200	661,5	540	490	ø 20	100	42	300	600	738	4	100	360	225	16	16	384
NC50-125	65	50	2,2	90L	1004/CA	849	690	60	100	490	370	320	ø 16	65	38	197	335	385	4	100	360	160	16	16	73
NC50-125	65	50	3	100L	1005/CA	869	724,5	60	100	524,5	370	320	ø 16	65	38	197	347	405	4	100	360	160	16	16	80
NC50-125	65	50	4	112M	1121/CA	904	732	60	100	532	370	320	ø 16	65	38	197	369	440	4	100	360	160	16	16	82
NC50-125	65	50	5,5	132S	1122/CA	919	773	60	150	473	405	355	ø 16	65	38	197	389	455	4	100	360	160	16	16	95

BGAN = Base and coupling

\* = Indicatives values according to the type of motor installed.

BGAN = Socle et accouplement

\* = Valeurs indicatives en fonction de la marque du moteur utilisé.

BGAN = Base e giunto

\* = Valori indicativi in funzione della marca di motore utilizzato.

Selection - dimensions and weights for base mounted electric pumps  
 Sélection - dimensions et poids des électropompes sur socle  
 Selezione - dimensioni e pesi elettropompe su base

COUPLINGS WITH STANDARDIZED ENCLOSED ELECTRIC MOTORS  
 ACCOUPLEMENTS AVEC MOTEURS ÉLECTRIQUES FERMÉS NORMALISÉS  
 ACCOPIAMENTI CON MOTORI ELETTRICI CHIUSI NORMALIZZATI

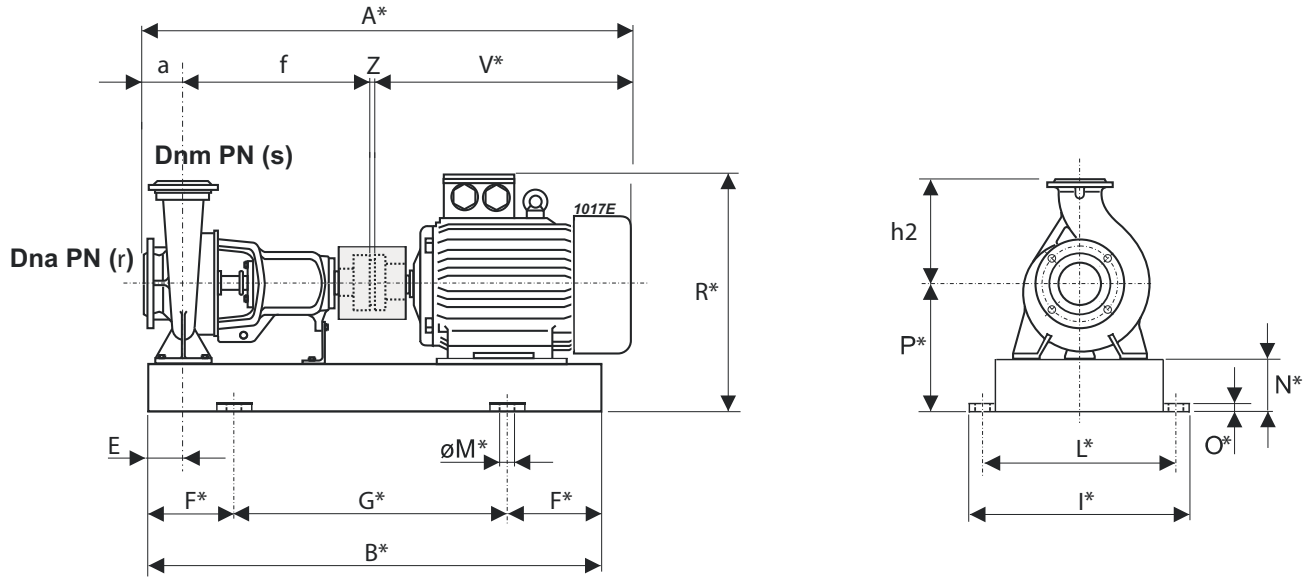

Pump Pompe Pompa		Motor Moteur Motore		BGAN	A*	B*	E	F*	G*	I*	L*	M*	N*	O*	P*	R*	V*	Z	a	f	h2	r	s	Weight Poids Peso	
Type Type Tipo	DNa [mm]	DNm [mm]	[kW]	Size Taille Grand.	Type Type Tipo	[mm]																			[kg]
NC32-125	50	32	1,1	90S	1002/CA	799	665	60	100	465	320	270	ø 16	50	38	162	300	355	4	80	360	140	16	16	59
NC32-125	50	32	1,5	90L	1003/CA	829	690	60	100	490	320	270	ø 16	50	38	162	300	385	4	80	360	140	16	16	63
NC32-160	50	32	0,75	80M	1040/CA	739	659	60	100	459	370	320	ø 16	65	38	197	322	295	4	80	360	160	16	16	24307
NC32-160	50	32	1,1	90S	1041/CA	799	665	60	100	465	370	320	ø 16	65	38	197	335	355	4	80	360	160	16	16	71
NC32-200	50	32	0,75	80M	1042/CA	739	649	60	100	449	370	320	ø 16	80	38	240	365	295	4	80	360	180	16	16	83
NC32-200	50	32	1,1	90S	1043/CA	799	665	60	100	465	370	320	ø 16	80	38	240	378	355	4	80	360	180	16	16	85
NC32-200	50	32	1,5	90L	1044/CA	829	690	60	100	490	370	320	ø 16	80	38	240	378	385	4	80	360	180	16	16	88
NC32-250	50	32	2,2	100L	1050/CA	869	737	72,5	100	537	450	400	ø 20	100	42	280	430	405	4	100	360	225	16	16	131
NC32-250	50	32	3	100L	1050/CA	869	737	72,5	100	537	450	400	ø 20	100	42	280	430	405	4	100	360	225	16	16	135
NC32-250	50	32	4	112M	1051/CA	904	744,5	72,5	100	544,5	450	400	ø 20	100	42	280	452	440	4	100	360	225	16	16	131
NC40-125	65	40	1,1	90S	1010/CA	799	665	60	100	465	340	290	ø 16	50	38	162	300	355	4	80	360	140	16	16	61
NC40-160	65	40	0,75	80M	1040/CA	739	659	60	100	459	370	320	ø 16	65	38	197	322	295	4	80	360	160	16	16	24308
NC40-160	65	40	1,1	90S	1041/CA	799	665	60	100	465	370	320	ø 16	65	38	197	335	355	4	80	360	160	16	16	72
NC40-200	65	40	0,75	80M	1047/CA	759	649	60	100	449	395	345	ø 16	80	38	240	365	295	4	100	360	180	16	16	73
NC40-200	65	40	1,1	90S	1048/CA	819	665	60	100	465	395	345	ø 16	80	38	240	378	355	4	100	360	180	16	16	89
NC40-200	65	40	1,5	90L	1049/CA	849	690	60	100	490	395	345	ø 16	80	38	240	378	385	4	100	360	180	16	16	94
NC40-250	65	40	2,2	100L	1050/CA	869	737	72,5	100	537	450	400	ø 20	100	42	280	430	405	4	100	360	225	16	16	133
NC40-250	65	40	3	100L	1050/CA	869	737	72,5	100	537	450	400	ø 20	100	42	280	430	405	4	100	360	225	16	16	137
NC40-250	65	40	4	112M	1051/CA	904	744,5	72,5	100	544,5	450	400	ø 20	100	42	280	452	440	4	100	360	225	16	16	133
NC40-315	65	40	4	112M	1053/DX	1039	854,5	72,5	150	554,5	475	425	ø 20	100	42	300	472	440	4	125	470	225	16	16	178
NC40-315	65	40	5,5	132S	1054/DX	1054	895,5	72,5	150	595,5	475	425	ø 20	100	42	300	492	455	4	125	470	225	16	16	185
NC40-315	65	40	7,5	132M	1055/DX	1089	933,5	72,5	150	633,5	475	425	ø 20	100	42	300	492	490	4	125	470	225	16	16	195
NC40-315	65	40	11	160M	1056/EX	1226	1019,5	72,5	150	719,5	475	425	ø 20	100	42	300	551	627	4	125	470	225	16	16	270
NC50-125	65	50	0,75	80M	1040/CA	759	659	60	100	459	370	320	ø 16	65	38	197	322	295	4	100	360	160	16	16	24306
NC50-160	65	50	0,75	80M	1047/CA	759	649	60	100	449	395	345	ø 16	80	38	240	365	295	4	100	360	180	16	16	73
NC50-160	65	50	1,1	90S	1048/CA	819	665	60	100	465	395	345	ø 16	80	38	240	378	355	4	100	360	180	16	16	83
NC50-160	65	50	1,5	90L	1049/CA	849	690	60	100	490	395	345	ø 16	80	38	240	378	385	4	100	360	180	16	16	88
NC50-200	65	50	1,1	90S	1048/CA	819	665	60	100	465	395	345	ø 16	80	38	240	378	355	4	100	360	200	16	16	91
NC50-200	65	50	1,5	90L	1049/CA	849	690	60	100	490	395	345	ø 16	80	38	240	378	385	4	100	360	200	16	16	96
NC50-200	65	50	2,2	100L	1052/CA	869	724,5	60	100	524,5	395	345	ø 16	80	38	240	390	405	4	100	360	200	16	16	107
NC50-250	65	50	2,2	100L	1050/CA	869	737	72,5	100	537	450	400	ø 20	100	42	280	430	405	4	100	360	225	16	16	143
NC50-250	65	50	3	100L	1050/CA	869	737	72,5	100	537	450	400	ø 20	100	42	280	430	405	4	100	360	225	16	16	147
NC50-250	65	50	4	112M	1051/CA	904	744,5	72,5	100	544,5	450	400	ø 20	100	42	280	452	440	4	100	360	225	16	16	143
NC50-315	65	50	4	112M	1132/DX	1039	854,5	72,5	150	554,5	475	425	ø 20	120	42	345	517	440	4	125	470	280	16	16	195
NC50-315	65	50	5,5	132S	1133/DX	1054	895,5	72,5	150	595,5	475	425	ø 20	120	42	345	537	455	4	125	470	280	16	16	201
NC50-315	65	50	7,5	132M	1134/DX	1089	933,5	72,5	150	633,5	475	425	ø 20	120	42	345	537	490	4	125	470	280	16	16	211
NC50-315	65	50	11	160M	1135/EX	1226	1029,5	72,5	150	729,5	475	425	ø 20	120	42	345	596	627	4	125	470	280	16	16	325
NC65-125	80	65	0,75	80M	1152/CA	759	661,5	72,5	100	461,5	410	360	ø 16	80	38	240	365	295	4	100	360	180	16	16	84
NC65-125	80	65	1,1	90S	1153/CA	819	677,5	72,5	100	477,5	410	360	ø 16	80	38	240	378	355	4	100	360	180	16	16	85

BGAN = Base and coupling      BGAN = Socle et accouplement      BGAN = Base e giunto  
 \* = Indicatives values according to the type of motor installed.      \* = Valeurs indicatives en fonction de la marque du moteur utilisé.      \* = Valori indicativi in funzione della marca di motore utilizzato.